





## LE BUFFET EVENTO

**D**u petit-déjeuner au dîner, des buffets sucrés aux buffets salés, la collection **EVENTO** répond à tous les scénarios de réception. Un design **homogène, harmonieux, fonctionnel et modulable**. La **richesse de ses combinaisons** et la **diversité de ses matériaux** (acier, porcelaine, verre, grès, mélamine pierre et bois etc...) **s'adaptent à votre style** et à la **dimension de votre établissement**. La collection **EVENTO** valorise avec une touche de chic la mise en scène de vos buffets, selon le moment de la journée, de la saison...

### KITCHENWARE FOR YOUR BUFFET

From **breakfast to dinner**, from sweet buffets to savoury spreads, the **EVENTO** collection works for all your reception needs. A **unified, harmonious, practical and modular** design. With a **host of combinations** and a **range of materials** to choose from (steel, porcelain, glass, stoneware, melamine, stone and wood...), you can find what **works for your style** and the **size of your space**. The **EVENTO** collection adds a chic touch to your buffet presentations to reflect the time of day or the season.

### CREACIÓN DE UN BUFÉ

La colección **EVENTO** resulta perfecta para cualquier recepción, tanto para bufés dulces como salados, del **desayuno a la cena**. Un diseño **homogéneo, armonioso, funcional y modulable**. La **riqueza de sus combinaciones** y la **diversidad de sus materiales** (acero, porcelana, cristal, gres, melamina de piedra y madera...) **se amoldan a su estilo** y a las **dimensiones de su establecimiento**. La colección **EVENTO** aporta un toque sofisticado para realzar la presentación de sus bufés según el momento del día, de la temporada.

#### EVENTO

PLATEAUX POUR MODULES FROIDS P.226  
PLATTERS FOR REFRIGERATED UNITS - BANDEJAS PARA LOS MODULOS REFRIGERADOS

PLATEAUX ROUNDS P.234  
ROUND TRAY - BANDEJA REDONDA

PLATEAUX GN 1/1 - 2/3 - 1/2 - 1/3 - MELAMINE PIERRE - MELAMINE BOIS P.226  
TRAY - BANDEJA - STONE MELAMINE - WOOD MELAMINE  
MELAMINA PIEDRA - MELAMINA MADERA



## CHAFING DISHES\*

LE CHAFING DISH, PAR SON **DESIGN CONTEMPORAIN** ALLIANT ACIER, PORCELAIN ET VERRE OFFRE À VOTRE BUFFET UNE **PRÉSENTATION SOIGNÉE ET RAFFINÉE**.

THE CHAFING DISH, WITH ITS **CONTEMPORARY DESIGN** THAT COMBINES STEEL, PORCELAIN AND GLASS, BRINGS A **SMART AND SOPHISTICATED TOUCH** TO YOUR BUFFET DISPLAY.

EL CHAFING DISH, POR SU **DISEÑO CONTEMPORÁNEO** QUE COMBINA ACERO, PORCELANA Y CRISTAL OFRECE A SU BUFFET UNA PRESENTACIÓN **CUIDADA Y REFINADA**.

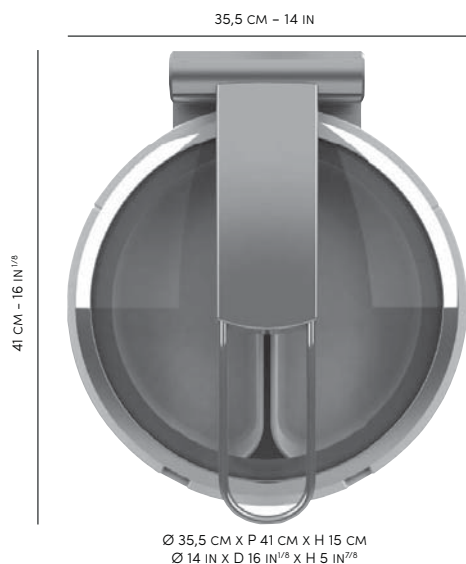

**Couvercle en verre transparent** pour percevoir le contenu et rendre le buffet plus gourmand

**Clear glass cover** allows contents to be viewed instantly and makes the buffet more enticing

**Cubierta de vidrio transparente** permite que el contenido pueda ser visto instantáneamente y hace que el buffet más atractivo

**Charnière avec vérin et amortisseur** pour un réel confort d'utilisation et une fermeture en douceur

**The hydraulic buffering hinge** offers user comfort and convenience with its soft closure mechanism

**La bisagra con amortiguación hidráulica** ofrece al usuario comodidad y conveniencia con su mecanismo de cierre suave



**Encoches pour les couverts de service**

**The notch for the serving cutlery**

**El agua condensada se recoge mediante un sistema de la ranura para las piezas de servicio**

**Compatible plaque induction, avec résistance électrique ou porte-brûleur avec gel combustible**

**Compatible with induction, electrical and/or «sterno» fuel heating system**

**Compatible con inducción, eléctrico o sistema de color externo**

**Système de récupération d'eau de condensation**

**Condensation water collection system in the porcelain insert**

**El agua condensada se recoge mediante un sistema de recolección en la base de porcelana**

\*CERTAINES PIÈCES SONT DISPONIBLES EN PIÈCES DÉTACHÉES  
SOME ITEMS ARE AVAILABLE INDIVIDUALLY  
ALGUNOS DE ESTOS ARTICULOS ESTÁN DISPONIBLES COMO PIEZAS SEPARADAS

©Patrick ROUGEREAU



Chafing dishes

# EVENTO





236195  
**CHAFING DISH SANS BAC FINITION MIROIR**  
 CHAFING DISH WITHOUT INSERT MIRROR FINISH  
 CHAFING DISH SIN BANDEJA ACABADO BRILLO  
 Ø 35,5 CM - P 41 CM - H 15 CM  
 Ø 14 IN - D 16 IN<sup>1/8</sup> - H 5 IN<sup>7/8</sup>

**Acier inoxydable, couvercle avec gouttière, verre trempé**  
 Stainless steel, lid with groove, tempered glass  
 Acero inoxidable, tapa con canalón vidrio templado



236194  
**CHAFING DISH SANS BAC FINITION BROSSÉE**  
 CHAFING DISH WITHOUT INSERT BRUSHED FINISH  
 CHAFING DISH SIN BANDEJA ACABADO SATINADO  
 Ø 35,5 CM - P 41 CM - H 15 CM  
 Ø 14 IN - D 16 IN<sup>1/8</sup> - H 5 IN<sup>7/8</sup>

**Acier inoxydable, couvercle avec gouttière, verre trempé**  
 Stainless steel, lid with groove, tempered glass  
 Acero inoxidable, tapa con canalón vidrio templado



203470  
**COUVERCLE AVEC GOUTTIÈRE ACIER, VERRE TREMPÉ**  
 LID WITH STAINLESS STEEL GUTTER, TEMPERED GLASS  
 TAPA EN ACERO INOX Y VIDRIO TEMPLADO  
 Ø 33 CM - 13 IN



216142  
**BAC ACIER POUR CHAFING DISH**  
 CHAFING STAINLESS STEEL INSERT  
 BANDEJA DE ACERO INOXIDABLE PARA CHAFING  
 Ø 35,6 X H 7 CM - CONTENANCE 3L  
 Ø 14 X 2 IN<sup>3/4</sup> - CAPACITY 100 OZ



215721  
**BAC PORCELAINE POUR CHAFING DISH**  
 CHAFING PORCELAIN INSERT  
 BANDEJA DE PORCELANA PARA CHAFING  
 Ø 35,6 X H 7 CM - CONTENANCE 3L  
 Ø 14 X 2 IN<sup>3/4</sup> - CAPACITY 100 OZ



202635  
**1/2 BAC PORCELAINE POUR CHAFING DISH**  
 1/2 CHAFING PORCELAIN INSERT  
 1/2 BANDEJA DE PORCELANA PARA CHAFING  
 L 29 X L15 X H 4,5 CM - CONTENANCE 1L  
 11 IN<sup>7/16</sup> X 5 IN<sup>7/8</sup> X 1 IN<sup>3/4</sup> - CAPACITY 33 OZ<sup>13/16</sup>



236684 **NEW**  
**1/2 BAC PORCELAINE POUR CHAFING DISH AVEC SEPARATEUR**  
 1/2 PORCELAIN INSERT FOR CHAFING DISH  
 1/2 BANDEJA DE PORCELANA CON DELIMITADOR PARA CHAFING  
 L 29,3 CM X H 4,6 CM  
 L 11 IN<sup>9/16</sup> X H 1 IN<sup>13/16</sup>

**SUPPORT CHAFING**  
**ACIER INOXYDABLE POUR RÉSISTANCE ÉLECTRIQUE OU PORTE-BRÛLEUR AVEC GEL COMBUSTIBLE**  
 CHAFING STAND STAINLESS STEEL, FOR ELECTRICAL AND/OR STERNO HEATING PURPOSES  
 SOPORTE PARA CHAFING DISH ACERO INOXIDABLE PARA RESISTENCIA ELÉCTRICA O CALENTADOR EXTERNO

Ø 35 CM - P 40 CM - H 12,5 CM  
 Ø 13 IN<sup>3/4</sup> X D 15 IN<sup>3/4</sup> X H 4 IN<sup>15/16</sup>



203005  
**FINITION MIROIR**  
 MIRROR FINISH  
 ACABADO BRILLO

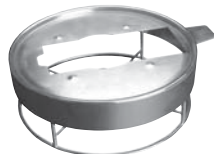

202859  
**FINITION BROSSÉE**  
 BRUSHED FINISH  
 ACABADO SATINADO



**RÉSISTANCE AVEC RÉGULATEUR DE TEMPÉRATURE**  
 HEATING ELEMENT - HEAT ADJUSTABLE  
 RESISTENCIA CON REGULADOR DE TEMPERA  
 202860 - 220 /240 V /200 W  
 203468 - 110 /120 V  
 20 X 20 CM - 7 IN<sup>7/8</sup> X 7 IN<sup>7/8</sup>



202861  
**PORTE-BRÛLEUR POUR GEL COMBUSTIBLE ACIER**  
 BURNER HOLDER STEEL  
 QUEMADOR ACERO INOXIDABLE  
 Ø 9 CM - H 6 CM  
 Ø 3 IN<sup>9/16</sup> X 2 IN<sup>3/8</sup>

Chafing dishes

# EVENTO



## MODULES FROIDS\*

REFRIGERATED UNITS - MODULOS REFRIGERADOS

LE MODULE RÉFRIGÉRÉ REÇOIT UNE **LARGE GAMME DE CONTENANTS**, PLATEAUX ET ACCESSOIRES **MULTI-MATÉRIAUX** AU FORMAT GN EN PORCELAINE, VERRE, ACIER, ACRYLIQUE, MÉLAMINE PIERRE ET MÉLAMINE BOIS. **ILS PERMETTENT UNE INFINITÉ DE COMBINAISONS.**

THE REFRIGERATED UNIT WILL HOLD A **WIDE RANGE OF PLATTERS AND MULTI-MATERIAL ACCESSORIES** IN INDUSTRY STANDARD FORMAT IN PORCELAIN, GLASS, STEEL, ACRYLIC, STONE AND WOOD MELAMINE **ALLOWING ENDLESS COMBINATIONS.**

EL MÓDULO REFRIGERADO PRESENTA **UNA AMPLIA VARIEDAD DE BANDEJAS Y ACCESORIOS DE MÚLTIPLES MATERIALES** EN FORMATO GN EN PORCELANA, VIDRIO, ACERO, ACRÍLICO, MELAMINA DE PIEDRA Y MELAMINA MADERA QUE **PERMITEN UN NÚMERO INFINITO DE COMBINACIONES.**



**MODULE ACIER GN 1/1<sup>(1)</sup>  
+ BAC PLASTIQUE**  
REFRIGERATED SET  
+ PLASTIC TRAY GN 1/1  
MODULO DE ACERO  
+ BANDEJA GN 1/1  
L 56,5 CM - P 36 CM - H 9,5 CM  
22 IN<sup>1/4</sup> - D 14 IN<sup>3/16</sup> X 3 IN<sup>3/4</sup>

**202864  
FINITION MIROIR**  
STAINLESS STEEL MIRROR  
ACABADO BRILLO

**202865  
FINITION BROSSÉE**  
STAINLESS STEEL BRUSHED  
ACABADO SATINADO

**202869  
NOIR MÉTALLISÉ**  
METALLIC BLACK  
ACABADO NEGRO METALICO

**MODULE ACIER GN 1/2<sup>(1)</sup>  
+ BAC PLASTIQUE**  
REFRIGERATED SET  
+ PLASTIC TRAY GN 1/2  
MODULO DE ACERO  
+ BANDEJA GN 1/2  
29,5 X 35,6 CM  
11 IN<sup>5/8</sup> X 14 IN

**235356  
FINITION MIROIR**  
STAINLESS STEEL MIRROR  
ACABADO BRILLO

**235361  
FINITION BROSSÉE**  
STAINLESS STEEL BRUSHED  
ACABADO SATINADO

**235362  
NOIR MÉTALLISÉ**  
METALLIC BLACK  
ACABADO NEGRO METALICO

56,5 CM - 22 IN<sup>1/4</sup>

36 CM - 14 IN<sup>13/16</sup>

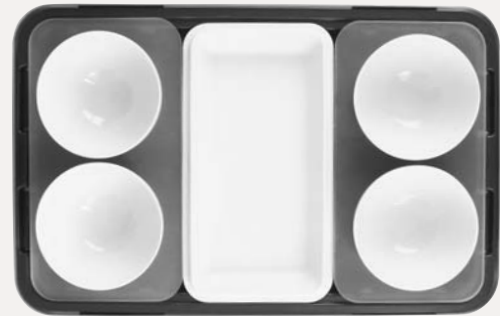

L 56,5 CM X P 36 CM X H 9,5 CM  
22 IN<sup>1/4</sup> X D 14 IN<sup>3/16</sup> X 3 IN<sup>3/4</sup>



**202871  
COUVERCLE MODULE  
RÉFRIGÉRÉ POIGNÉE INOXYDABLE**  
LID FOR REFRIGERATED SET/  
STAINLESS STEEL HANDLE  
CUBIERTA PARA EL MODULO  
REFRIGERADO/ASA ACERO INOXIDABLE  
56 X 35 X 19 CM  
22 IN<sup>1/16</sup> X 13 IN<sup>3/4</sup> X 7 IN<sup>1/2</sup>

**208357  
PLAQUE EUTECTIQUE POUR  
MODULE FROID GN1/1**  
BLACK COOLING  
EUTECTIQUE BLOCK FOR UNIT GN1/1  
NEGRO ACUMULADOR DE  
REFRIGERACION 1/1  
48 X 28 X 3 CM  
18 IN<sup>7/8</sup> X 11 IN X 1 IN<sup>3/16</sup>

**234568  
PLAQUE EUTECTIQUE POUR  
MODULE FROID GN 1/2**  
BLACK COOLING  
EUTECTIQUE BLOCK FOR UNIT GN1/2  
NEGRO ACUMULADOR DE  
REFRIGERACION 1/2  
18 X 25 CM  
7 IN<sup>18/16</sup> X 9 IN<sup>13/16</sup>

<sup>(1)</sup> GARANTIE LAVE-VAISSELLE  
DISH WASHER SAFE  
GARANTIA LAVA-VAJILLAS

\*CERTAINES PIÈCES SONT DISPONIBLES EN PIÈCES DÉTACHÉES  
SOME ITEMS ARE AVAILABLE INDIVIDUALLY  
ALGUNOS DE ESTOS ARTICULOS ESTÁN DISPONIBLES COMO  
PIEZAS SEPARADAS



# EVENTO





## PLATEAUX POUR MODULES FROIDS

PLATTERS FOR REFRIGERATED UNITS  
BANDEJAS PARA LOS MODULOS REFRIGERADOS

	GN 1/1 53,5 X 32,5 CM 20 IN <sup>7/8</sup> X 12 IN <sup>13/16</sup>	GN 2/3 35,4 X 32,5 CM 13 IN <sup>15/16</sup> X 12 IN <sup>13/16</sup>	GN 1/2 26,4 X 32,5 CM 10 IN <sup>3/8</sup> X 12 IN <sup>13/16</sup>	GN 1/3 17,5 X 32,5 CM 6 IN <sup>7/8</sup> X 12 IN <sup>13/16</sup>	GN 1/6 8,7 X 32,5 CM 3 IN <sup>7/16</sup> X 12 IN <sup>13/16</sup>
<b>PLATEAU GRÈS CARBONE<sup>(1)</sup></b> GRES STONWARE TRAY BANDEJA GRES TONO CARBONO  234550 - GN 2/3 234555 - GN 1/3					
<b>PLAT À REBORDS GRÈS CARBONE<sup>(1)</sup></b> GREY STONWARE EDGE TRAY BANDEJA CON BORDES GRES TONO CARBONO  234556 - GN 1/3					
<b>PLATEAU PORCELAINE</b> WHITE ENAMELLED PORCELAIN TRAY BANDEJA PORCELANA  202628 - GN 2/3 202629 - GN 1/2 202627 - GN 1/3					
<b>PLAT CREUX PORCELAINE</b> WHITE ENAMELLED PORCELAIN DEEP DISH BANDEJA PORCELANA  202630 - GN 1/3					

### PLATEAU MÉLAMINE BOIS<sup>(2)</sup>

WOOD MELAMINE TRAY  
BANDEJA MELAMINA MADERA

234546 - GN 1/1  
234548 - GN 2/3  
234551 - GN 1/2  
234553 - GN 1/3

### PLATEAU 3 TROUS MÉLAMINE BOIS<sup>(2)</sup>

WOOD MELAMINE TRAY 3 HOLES  
BANDEJA MELAMINA MADERA CON 3 HUELLAS

234557 - GN 1/6

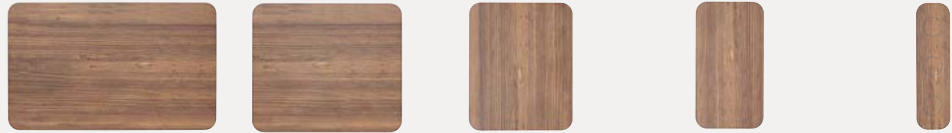

### PLATEAU MÉLAMINE PIERRE<sup>(2)</sup>

STONE MELAMINE TRAY  
BANDEJA MELAMINA PIEDRA

234547 - GN 1/1  
234549 - GN 2/3  
234552 - GN 1/2  
234554 - GN 1/3

### PLATEAU 3 TROUS MÉLAMINE PIERRE<sup>(2)</sup>

STONE MELAMINE TRAY 3 HOLES  
BANDEJA MELAMINA PIEDRA CON 3 HUELLAS

234558 - GN 1/6

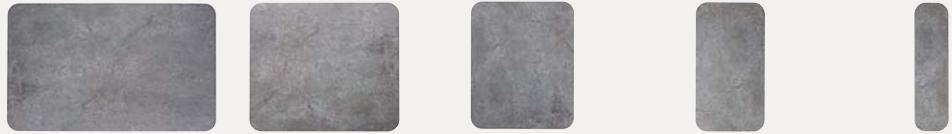

### PLATEAU ACIER 18-10

NEWPORT FINITION MIROIR  
SERVING TRAY STAINLESS STEEL 18-10  
MIRROR FINISHED  
BANDEJA RECTANGULAR ACERO 18-10  
ACABADO BRILLO

185021 - 238962\* - GN 1/1  
185019 - 238960\* - GN 1/2

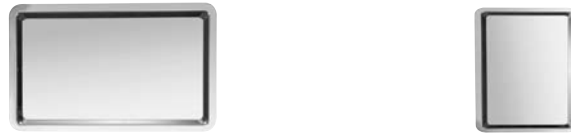

### PLATEAU VERRE ÉPAISSEUR 0,6 CM

TEMPERED GLASS TRAY THICKNESS 1/4  
BANDEJA CRISTAL GROSOR 0,6 CM

230752 - GN 1/1  
230753 - GN 2/3



### PLATEAU ACRYLIQUE ÉPAISSEUR 1 CM

ACRYLIC TRAY THICKNESS 3/8  
BANDEJA ACRÍLICO GROSOR 1 CM

2 TROUS - 2 HOLES - 2 AGUJEROS

230756 - GN 1/1

1 TROU - 1 HOLE - 1 AGUJERO

230755 - GN 1/2  
Adapté aux bols 22 cm - Adapted for bowls  
8,6 inch - Adaptados a boles de 22 cm

2 TROUS - 2 HOLES - 2 AGUJEROS

230757 - GN 1/3  
Adapté aux bols 14 cm - Adapted for bowls  
5,5 inch - Adaptados a boles de 14 cm



\*NOUVEAUX CODES À PARTIR DU 01/04/2020  
NEW CODES VALID FROM 2020/04/01  
NUEVOS CODIGOS A PARTIR DE 01/04/2020

(1) GARANTIE LAVE-VAISSELLE  
DISH WASHER SAFE  
GARANTIA LAVA-VAJILLAS

GARANTIE MICRO-ONDES  
MICROWAVE SAFE  
GARANTIA MICRO-ONDAS

(2) COMPATIBLE LAVE-VAISSELLE  
DISH WASHER SAFE  
GARANTIA LAVA-VAJILLAS

NON COMPATIBLE MICRO-ONDES  
DON'T USE WITH MICRO-WAVE  
NO VA EN EL MICRO-ONDAS

# EVENTO



## URNES À JUS DE FRUITS\*

FRUIT JUICE URNS - DISPENSADORES DE ZUMOS

URNE À JUS DE FRUIT DOTÉE D'UN TUBE CENTRAL EN ACIER POUR GLACE PILÉE :  
**PARFAIT MAINTIEN DE LA FRAÎCHEUR**

FRUIT JUICE URN WITH CENTRAL STEEL TUBE TO HOLD CRUSHED ICE,  
**FOR PERFECT FRESHNESS**

DISPENSADOR DE ZUMOS DOTADO CON UN TUBO CENTRAL DE ACERO PARA  
HIELO PICADO **PARA MANTENER LA FRESCURA**

### URNE À JUS DE FRUITS 4L - ACIER 18-10

JUICE DISPENSER 135 OZ STAINLESS STEEL  
DISPENSADOR DE ZUMO ACERO

231303	231304
<b>MIROIR</b>	<b>BROSSÉ</b>
MIRROR	BRUSHED
ACABADO BRILLO	ACABADO SATINADO

### 202855 BOUCHON DE CARAFE SILICONE

STOPPER FOR CARAFE - SILICONE  
TAPÓN PARA BOTELLA - SILICONA  
Ø 6,5 CM - H 4,2 CM  
Ø 2 IN<sup>9/16</sup> X H 1 IN<sup>5/8</sup>



### 202639 CARAFE À JUS DE FRUIT - 1,2 L CRISTALLIN SOUFFLÉ BOUCHE

JUICE/BEVERAGE CARAFE - 40 OZ<sup>9/16</sup>  
HAND BLOWN CRYSTALLINE  
BOTELLA PARA ZUMOS  
CRISTAL SOPLADO EN BOCA  
Ø 10,5 CM - H 27,5 CM  
Ø 4 IN<sup>1/8</sup> X H 10 IN<sup>3/16</sup>

### NEW

237501  
**RAFRAÎCHISSEUR DROIT DOUBLE PAROI**  
CURVED DOUBLE WALL WINE COOLER  
ENFRIADOR DE BOTELLA DOBLE PARED  
Ø 13,9 X H 19,8 CM  
Ø 5 IN<sup>7/8</sup> X H 7 IN<sup>13/16</sup>



202632  
**ÉTIQUETTE PORCELAINE  
AVEC AIMANT+ SUPPORT ACIER**  
PORCELAIN STICK + STAINLESS STEEL STAND  
WITH MAGNET  
ÉTIQUETA PORCELANA + SOPORTE ACERO  
INOX CON IMÁN  
10 X 5 CM - 3 IN<sup>15/16</sup> X 1 IN<sup>15/16</sup>



\*CERTAINES PIÈCES SONT DISPONIBLES EN PIÈCES DÉTACHÉES  
SOME ITEMS ARE AVAILABLE INDIVIDUALLY  
ALGUNOS DE ESTOS ARTICULOS ESTÁN DISPONIBLES COMO PIEZAS SEPARADAS

20 CM - 7 IN<sup>7/8</sup>

45 CM - 17 IN<sup>11/16</sup>



4L - 135 OZ  
L 20 CM X P 32 CM X H 45 CM  
W 7 IN<sup>7/8</sup> X D 12 IN<sup>5/8</sup> X H 17 IN<sup>11/16</sup>



### BOUCHON VERSEUR EN SILICONE, POUR UNE MEILLEURE HYGIÈNE

HYGIENIC SILICONE POURING STOPPER

TAPÓN DE SILICONA PARA MAYOR HIGIENE  
Y CONTROL DEL VERTIDO

### POSSIBILITÉ D'AIMANTER L'ÉTIQUETTE PORCELAINE SUR LE COUVERCLE

MAGNETIC PORCELAIN  
NAME PLATE ACCESSORY  
FOR LID PLACEMENT

PLACA DE PORCELANA  
MAGNÉTICA PARA COLOCAR  
LOS NOMBRES



# EVENTO



## DISTRIBUTEURS À CÉRÉALES\*

CEREAL DISPENSERS - DISPENSADORES DE CEREALES

DISTRIBUTEUR À CÉRÉALES 1 OU 3 TUBES

AVEC AILETTES SOUPLES POUR NE PAS CASSER LES CÉRÉALES

CEREAL DISPENSER 1 OR 3 TUBS WITH

FLEXIBLE SPOUT SO AS NOT TO BREAK THE CEREALS

DISPENSADOR DE CEREALES 1 O 3 TUBOS CON

PESTAÑAS FLEXIBLES PARA NO ROMPER LOS CEREALES



231300 - X3  
L 50 CM X P 20 CM X H 55,5 CM  
W 19 IN<sup>11/16</sup> X D 7 IN<sup>7/8</sup> X H 21 IN<sup>7/8</sup>  
CAPACITÉ : 3 X 3,5 L  
CAPACITY : 3 X 1 GAL

### 202855 BOUCHON DE CARAFE SILICONE

STOPPER FOR CARAFE - SILICONE  
TAPÓN PARA BOTELLA - SILICONA  
Ø 6,5 CM - H 4,2 CM  
Ø 2 IN<sup>3/16</sup> X H 1 IN<sup>5/8</sup>



### 202636 CARAFE À LAIT - 1,2 L PORCELAINE

PORCELAIN MILK JUG - 40 OZ<sup>9/16</sup>  
BOTELLA PARA LECHE  
PORCELANA  
Ø 10,5 CM - H 27,5 CM  
Ø 4 IN<sup>1/8</sup> X H 10 IN<sup>13/16</sup>

19 CM - 7 IN<sup>1/2</sup>

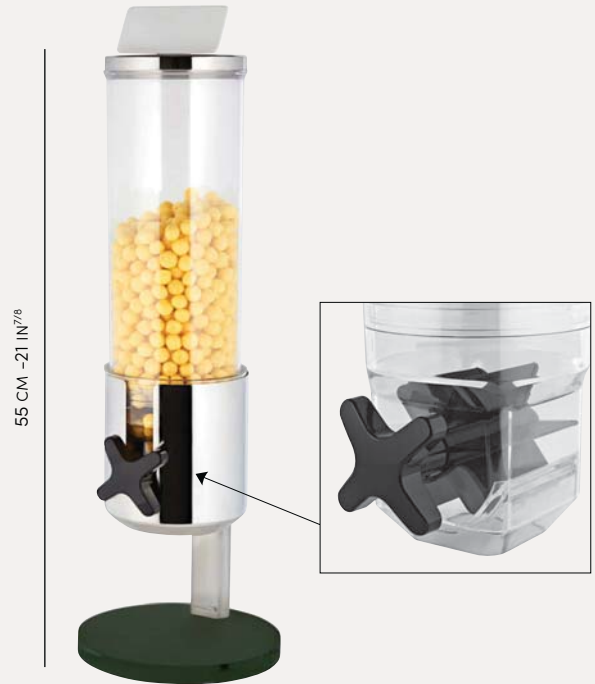

231299 - X1  
L 19 CM X P 20 CM X H 55,5 CM  
W 7 IN<sup>1/2</sup> X D 7 IN<sup>7/8</sup> X H 21 IN<sup>7/8</sup>  
CAPACITÉ : 3,5 L  
CAPACITY : 1 GAL

### 154245 BOL MODULO BLANC

WHITE MODULO BOWL  
BOL MODULO BLANCO  
14 CM - 5 IN<sup>1/2</sup>



### 202626 BOL EMPILABLE

PORCELAIN STACKABLE BOWL  
BOWL PORCELANA APILABLE  
14 CM - 5 IN<sup>1/2</sup>



\*CERTAINES PIÈCES SONT DISPONIBLES EN PIÈCES DÉTACHÉES  
SOME ITEMS ARE AVAILABLE INDIVIDUALLY  
ALGUNOS DE ESTOS ARTICULOS ESTÁN DISPONIBLES COMO PIEZAS SEPARADAS

# EVENTO



## SUPPORTS À FIL RECTANGULAIRES

RECTANGULAR TRAYS - SOPORTES RECTANGULARES

DES SUPPORTS EN **ACIER NOIR MAT DE HAUTEURS DIFFÉRENTES** POUR RYTHMER LES PRÉSENTATIONS

**BLACK MAT FINISH SUPPORTS OF DIFFERING HEIGHTS** CAN BE USED TO CREATE A VARIED PRESENTATION

SOPORTES DE **ACERO NEGRO DE DIFERENTES ALTURAS PARA MARCAR** EL RITMO DE LAS PRESENTACIONES

### 230741 SUPPORT RECTANGULAIRE NIVEAU 1

RECTANGULAR TRAY, LEVEL 1  
SOPORTE RECTANGULAR, NIVEL 1  
L 44 X P 30,8 X H 10,8 CM  
W 17 IN<sup>5/16</sup> X D 12 IN<sup>1/8</sup> X H 4 IN<sup>1/4</sup>



### 230742 SUPPORT RECTANGULAIRE NIVEAU 2

RECTANGULAR TRAY, LEVEL 2  
SOPORTE RECTANGULAR, NIVEL 2  
L 42 X P 30,8 X H 29,8 CM  
W 16 IN<sup>5/16</sup> X D 12 IN<sup>1/8</sup> X H 11 IN<sup>3/4</sup>

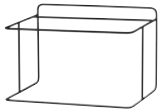

### 230741 + 230742 SUPPORT RECTANGULAIRE NIVEAU 1+2

RECTANGULAR TRAY, LEVEL 1+2  
SOPORTE RECTANGULAR, NIVEL 1+2  
L 44 X P 50 X H 29,8 CM  
W 17 IN<sup>5/16</sup> X D 19 IN<sup>11/16</sup> X H 11 IN<sup>3/4</sup>



### 230743 SUPPORT RECTANGULAIRE NIVEAU 3

RECTANGULAR TRAY, LEVEL 3  
SOPORTE RECTANGULAR, NIVEL 3  
L 40 X P 30,8 X H 48,8 CM  
W 15 IN<sup>3/4</sup> X D 12 IN<sup>1/8</sup> X H 19 IN<sup>3/16</sup>

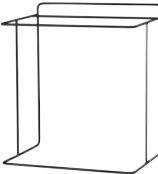

### 230742 + 230743 SUPPORT RECTANGULAIRE NIVEAU 2+3

RECTANGULAR TRAY, LEVEL 2+3  
SOPORTE RECTANGULAR, NIVEL 2+3  
L 42 X P 50 X H 48,8 CM  
W 16 IN<sup>5/16</sup> X D 19 IN<sup>11/16</sup> X H 19 IN<sup>3/16</sup>

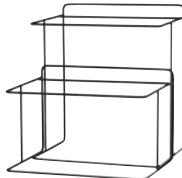

### 230741 + 230742 + 230743 SUPPORT RECTANGULAIRE NIVEAU 1+2+3

RECTANGULAR TRAY, LEVEL 1+2+3  
SOPORTE RECTANGULAR, NIVEL 1+2+3  
L 44 X P 68,2 X H 48,8 CM  
W 17 IN<sup>5/16</sup> X D 26 IN<sup>7/8</sup> X H 19 IN<sup>3/16</sup>



### 230749 PANIÈRE RECTANGULAIRE - GN 1/1

RECTANGULAR BREAD BASKET  
CESTA BOLLERÍA RECTANGULAR  
54 X 34 X H 7 CM  
21 IN<sup>1/4</sup> X 13 IN<sup>3/8</sup> X 2 IN<sup>3/4</sup>

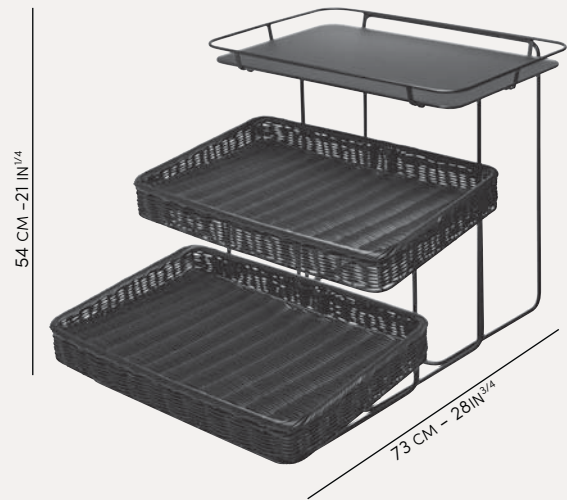

### PANIÈRE REVERSIBLE POUR UNE PRÉSENTATION DROITE OU INCLINÉE

REVERSIBLE BASKET FOR A LEVEL OR TITLED DISPLAY  
PANERA REVERSIBLE PARA UNA PRESENTACION DERECHA O INCLINADA



### 230744 CADRE ACIER POUR SUPPORT RECTANGULAIRE<sup>(1)</sup>

STEEL FRAME FOR STAND  
ESTRUCTURA DE ACERO  
L 55,5 X P 35 X H 4,5 CM  
W 21 IN<sup>7/8</sup> X D 13 IN<sup>3/4</sup> X H 1 IN<sup>3/4</sup>

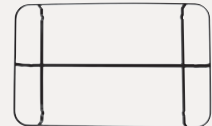

185021 - GN1/1  
PLATEAU ACIER 18-10  
NEWPORT FINITION MIROIR  
SERVING TRAY STAINLESS STEEL 18-10  
MIRROR FINISHED  
BANDEJA RECTANGULAR ACERO 18-10  
ACABADO BRILLO



230752 - GN1/1  
PLATEAU VERRE  
ÉPAISSEUR 0,6 CM  
TEMPERED GLASS TRAY THICKNESS 1/16  
BANDEJA CRISTAL GROSOR 0,6 CM



234546 - GN1/1  
PLATEAU MÉLAMINE BOIS<sup>(1)</sup>  
WOOD MELAMINE TRAY  
BANDEJA MELAMINA MADERA



234547 - GN1/1  
PLATEAU MÉLAMINE PIERRE<sup>(1)</sup>  
STONE MELAMINE TRAY  
BANDEJA MELAMINA PIEDRA



(1) À COMMANDER UNIQUEMENT POUR LES PLATEAUX GN 1/1  
TO ORDER ONLY FOR TRAYS GN 1/1  
SOLO PEDIR PARA LOS BANDEJAS GN1/1

(2) COMPATIBLE LAVE-VAISSELLE NON COMPATIBLE MICRO-ONDES  
DISH WASHER SAFE DONT USE WITH MICRO-WAVE  
GARANTIA LAVA-VAJILLAS NO VA EN EL MICRO-ONDAS

# EVENTO





## SUPPORTS À FIL RONDS

ROUND TRAYS - RONDOS BANDEJAS

POUR PANIÈRES RONDES, PLATEAUX 32 CM ET SALADIERS

STANDS FOR ROUND BASKETS, TRAYS 12 IN<sup>5/8</sup> AND SALAD BOWLS

SOPORTES PARA RONDO, BANDEJAS 32 CM, BOL Y ENSALADERAS

230745  
**SUPPORT ROND BAS**  
ROUND STAND, LOW LEVEL  
SOPORTE REDONDO BAJO  
Ø 25 CM X H 13 CM  
Ø 9 IN<sup>13/16</sup> X H 5 IN<sup>1/8</sup>



230746  
**SUPPORT ROND HAUT**  
ROUND STAND, HIGH LEVEL  
SOPORTE REDONDO ALTO  
Ø 25 CM X H 26 CM  
Ø 9 IN<sup>13/16</sup> X H 10 IN<sup>1/4</sup>



234564  
**SALADIER BAS GRÈS CARBONE<sup>(1)</sup>**  
GREY STONEWARE LOW SALAD BOWL  
ENSALADERA GRES TAMANO BAJO  
TONO CARBONO  
Ø 25,4 X 7 CM - 2,4 L  
Ø 10 IN X 2 IN<sup>3/4</sup> - 80 OZ<sup>1/8</sup>



136524  
**PLATEAU ROND  
PORCELAINE MODULO**  
PIE/PIZZA PLATE, FLAT  
FUENTE PARA PASTEL  
Ø 32 CM - 12 IN<sup>5/8</sup>



234563  
**SALADIER HAUT GRÈS CARBONE<sup>(1)</sup>**  
GREY STONEWARE HIGH SALAD BOWL  
ENSALADERA GRES TAMANO ALTO  
TONO CARBONO  
Ø 25,4 X 13 CM - 5,1 L  
Ø 10 IN X 5 IN<sup>1/8</sup> - 172 OZ<sup>7/16</sup>



234561  
**PLATEAU ROND  
MÉLAMINE BOIS<sup>(2)</sup>**  
WOOD MELAMINE  
ROUND TRAY  
BANDEJA REDONDA  
MELAMINA MADERA  
Ø 32 CM - 12 IN<sup>5/8</sup>

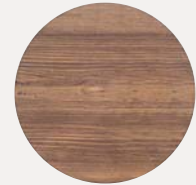

230748  
**PANIÈRE RONDE**  
ROUND BREAD BASKET  
CESTA BOLLERÍA REDONDA  
Ø 32 CM X H 8 CM  
Ø 12 IN<sup>5/8</sup> X H 3 IN<sup>1/8</sup>



234562  
**PLATEAU ROND  
MÉLAMINE PIERRE<sup>(2)</sup>**  
STONE MELAMINE  
ROUND TRAY  
BANDEJA REDONDA  
MELAMINA PIEDRA  
Ø 32 CM - 12 IN<sup>5/8</sup>



230750  
**PANIÈRE INDIVIDUELLE**  
INDIVIDUAL BREAD BASKET  
CESTA BOLLERÍA INDIVIDUAL  
Ø 18 CM X H 6 CM  
Ø 7 IN<sup>1/16</sup> X H 2 IN<sup>3/8</sup>



230754  
**PLATEAU ROND  
VERRE GRIS**  
GREY ROUND TRAY  
TEMPERED GLASS  
BANDEJA CRISTAL  
REDONDA  
Ø 32 CM - 12 IN<sup>5/8</sup>



### NEW

235223  
**SALADIER BAHIA DUNE**  
BEIGE DUNE BOWL  
ENSALADERA BEIS DUNA  
25 CM - 4L  
11 IN - 135 OZ<sup>1/4</sup>



### NEW

235222  
**SALADIER BAHIA BLEU ROCHE**  
BLUE STONE BOWL  
ENSALADERA AZUL DE ROCA  
25 CM - 4L  
11 IN - 135 OZ<sup>1/4</sup>



(1) COMPATIBLE LAVE-VAISSELLE  
DISH WASHER SAFE  
GARANTIA LAVA-VAJILLAS  
COMPATIBLE MICRO-ONDES  
MICROWAVE SAFE  
GARANTIA MICRO-ONDAS

(2) COMPATIBLE LAVE-VAISSELLE  
DISH WASHER SAFE  
GARANTIA LAVA-VAJILLAS  
NON COMPATIBLE MICRO-ONDES  
DONT USE WITH MICRO-WAVE  
NO VA EN EL MICRO-ONDAS



## ACCESSOIRES

ACCESSORIES - ACCESORIOS

230751  
**PANIÈRE À BAGUETTE**  
BAGUETTE BASKET  
CESTA PARA BAGUETTE  
27 CM X H 52 CM  
10 IN<sup>5/8</sup> X H 20 IN<sup>1/2</sup>



234559  
**PLANCHA AVEC MANCHE MÉLAMINE BOIS<sup>(1)</sup>**  
WOOD MELAMINE BOARD  
PLANCHA CON MANGO  
MELAMINA MADERA  
17,5 X 45 CM - 6 IN<sup>7/8</sup> X 17 IN<sup>11/16</sup>



234560  
**PLANCHA AVEC MANCHE MÉLAMINE PIERRE<sup>(1)</sup>**  
STONE MELAMINE BOARD  
PLANCHA CON MANGO  
MELAMINA PIEDRA  
17,5 X 45 CM - 6 IN<sup>7/8</sup> X 17 IN<sup>11/16</sup>



202632  
**ETIQUETTE PORCELAINE AVEC AIMANT + SUPPORT ACIER**  
PORCELAIN STICK + STAINLESS STEEL  
STAND + MAGNET  
ETIQUETA PORCELANA + SOPORTE ACERO  
INOX CON IMAN  
10 X 5 CM - 3 IN<sup>15/16</sup> X 1 IN<sup>15/16</sup>



202633  
**SUPPORT COUVERTS DE SERVICE PORCELAINE**  
SERVING CUTLERY DISPLAY  
WHITE PORCELAIN  
SOPORTE PARA PIEZAS DE SERVICIO  
PORCELANA BLANCA  
21 X 10 X 5 CM  
8 IN<sup>1/2</sup> X 3 IN<sup>15/16</sup> X 1 IN<sup>15/16</sup>



168845   
**CUILLÈRE À SPAGHETTI**  
SPAGHETTI SERVING SPOON  
CUCHARA PARA ESPAGUETIS  
29 CM - 11 IN<sup>7/16</sup>



168844   
**FOURCHETTE À VIANDE**  
MEAT FORK  
TENEDOR DE CARNE  
29 CM - 11 IN<sup>7/16</sup>



130610   
**REPOSE CUILLÈRE PORCELAINE**  
SPOON REST WITH CERAMIC BOWL  
CUCHARA DESCANSA EN PORCELANA  
H 23,5 CM X L 11,5 CM - 9 IN<sup>3/4</sup> X 4 IN<sup>1/2</sup>



153193   
**LOUCHE ASTRÉE MIROIR**  
SOUP LADLE  
CAZO  
29,7 CM - 11 IN<sup>11/16</sup>



202854  
**PLANCHE À PAIN BAMBOU AVEC RÉCUPÉRATEUR DE MIETTES (GN 1/1)**  
BAMBOO BREAD BOARD WITH CRUMB TRAY (GN 1/1)  
PANERA BAMBOO CON RECOGEDOR DE MIGAS (GN 1/1)  
53 X 32,5 CM - 20 IN<sup>7/8</sup> X 12 IN<sup>13/16</sup>



229516  
**COUPEAU L'ECONOME BY STARCK® POSITIONNABLE DANS LA PLANCHE**  
L'ECONOME BY STARCK® BREAD KNIFE FITS IN A SLOT IN THE BREAD BOARD  
CUCHILLO DE PAN L'ECONOME BY STARCK® SE ENCAJA EN UNA RANURA DE LA PANERA  
24 CM - 9 IN<sup>7/16</sup>



217814  
**COUPEAU L'ECONOME ECO NATURE® POSITIONNABLE DANS LA PLANCHE**  
L'ECONOME ECO NATURE® BREAD KNIFE FITS IN A SLOT IN THE BREAD BOARD  
CUCHILLO DE PAN L'ECONOME ECO NATURE® SE ENCAJA EN UNA RANURA DE LA PANERA  
18 CM - 7 IN<sup>1/16</sup>



217814  
**PRÉSENTOIR À GÂTEAUX ROND**  
ROUND APP / PIZZA / PRESENTATION STAND  
EXPOSITOR DE TARTAS



209381  
Ø 25 CM - 9 IN<sup>13/16</sup>

209382  
Ø 32 CM - 12 IN<sup>5/16</sup>

202625  
**BOL EVENTO BLANC**  
WHITE EVENTO BOWL  
BOL EVENTO BLANCO  
22 CM - 8 IN<sup>11/16</sup>



142722  
**BOL PORCELAINE MODULO**  
DEEP BOWL, LARGE  
BOL HONDO  
28 CM - 11 IN  
CONTENANCE : 2,5 L  
CAPACITY : 84 OZ<sup>9/16</sup>  
H : 12 CM - 4 IN<sup>3/4</sup>



204499  184355   
**PINCE À SERVIR**  
SERVING TONG  
PINZAS PARA SERVIR  
29,5 CM - 11 IN<sup>5/8</sup>



204498  101492   
**PINCE À PAIN**  
BREAD TONG  
PINZAS PAN  
23 CM - 9 IN<sup>1/16</sup>



204496  101494   
**CISEAUX À GÂTEAUX**  
PASTRY SCISSORS/TONG  
PINZAS PARA PASTELES  
20 CM - 7 IN<sup>7/8</sup>



130994   
**CUILLÈRE À TOAST**  
APPETIZER SPOON  
CUCHARA APERITIVO  
11,8 CM - 4 IN<sup>5/8</sup>



<sup>(1)</sup> COMPATIBLE LAVE-VAISSELLE  
DISH WASHER SAFE  
GARANTIA LAVA-VAJILLAS

NON COMPATIBLE MICRO-ONDES  
DON'T USE WITH MICRO-WAVE  
NO VA EN EL MICRO-ONDAS

<sup>(1)</sup> PLANCHE DE PRESENTATION UNIQUEMENT, NE PAS FAIRE DE DÉCOUPE  
PRESENTATION BOARD, DON'T CUT ON IT  
PLANCHA DE PRESENTACIÓN, NO ES COMPATIBLE CON EL CORTE

# EVENTO





29,5 CM - 11 IN<sup>5/8</sup>

56,5 CM - 22 IN<sup>1/4</sup>

56,5 CM - 22 IN<sup>1/4</sup>

56,5 CM - 22 IN<sup>1/4</sup>

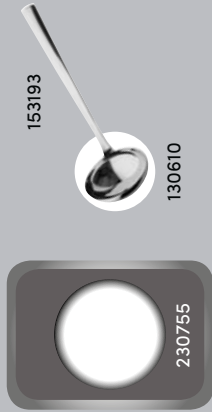

235361

230755

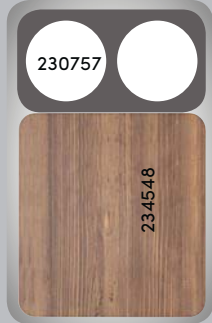

202865

230757

234548

202633

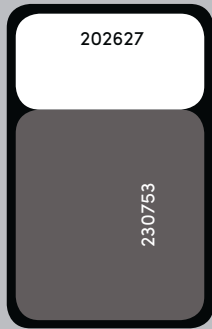

202869

202627

230753

202633

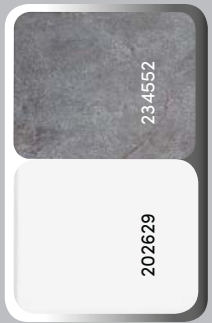

202864

234552

202629

202633

36 CM - 14 IN<sup>3/16</sup>

35,5 CM - 14 IN

35,5 CM - 14 IN

41 CM - 16 IN<sup>7/8</sup>



215722

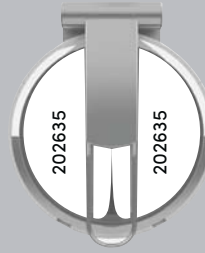

216144

230746 + 230748



230745 + 230750

68,2 CM - 26 IN<sup>7/8</sup>



230744 +

# EVENTO



Ø 25,4 CM X H 13 CM  
Ø 10 IN X H 5 IN<sup>1/8</sup>



234562  
Ø 32 CM - 12 IN<sup>5/8</sup>



20 CM - 7 IN<sup>7/8</sup>

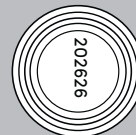
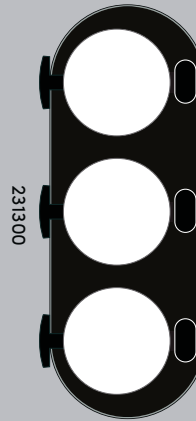

32 CM - 12 IN<sup>5/8</sup>

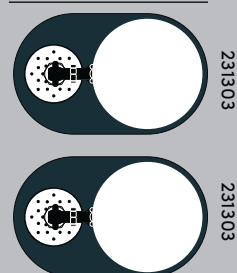

35,5 CM - 14 IN

50 CM - 19 IN<sup>11/16</sup>

20 CM  
7 IN<sup>7/8</sup>

20 CM  
7 IN<sup>7/8</sup>



## PIÈCES DÉTACHÉES

SPARE PARTS - PIEZAS SEPARADAS

### CHAFING DISH

203470  
**COUVERCLE AVEC GOUTTIÈRE  
ACIER ET VERRE TREMPÉ**  
LID WITH STAINLESS STEEL GUTTER,  
TEMPERED GLASS  
TAPA EN ACERO INOX  
Y VIDRIO TEMPLADO  
Ø 33 CM - Ø 13 IN

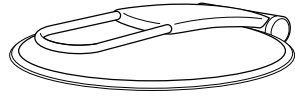

217435  
**KIT SAV VÉRINS POUR CHAFING DISH**  
REPLACING KIT FOR CHAFING DISH CYLINDER  
KIT PARA CAMBIAR EL CILINDRO DE UN CHAFING DISH

227406  
**JOINT POUR CHAFING DISH**  
SEAL FOR CHAFING DISH  
JUNTA PARA CHAFING DISH

### MODULE FROID

REFRIGERATED UNIT - MODULO REFRIGERADOS

202866  
**BAC PLASTIQUE**  
PLASTIC TRAY  
BANDEJA  
56 X 35,5 X 8 CM  
22 IN<sup>1/8</sup> X 14 IN X 3 IN<sup>1/8</sup>



235357  
**BAC PLASTIQUE**  
PLASTIC TRAY  
BANDEJA  
29,5 X 35,6 CM  
11 IN<sup>5/8</sup> X 14 IN



## EVENTO

## URNE À JUS DE FRUITS

FRUIT JUICE URN - DISPENSADOR DE ZUMOS

## COUVERCLE URNE ACIER 18-10

LID FOR STAINLESS DISPENSER 18-10  
TAPA PARA ACERO DISPENSADOR 18-10  
Ø 17,9 CM - 7 IN<sup>1/16</sup>

202881	202891
<b>MIROIR</b>	<b>BROSSÉ</b>
MIRROR	BRUSHED
ACABADO BRILLO	ACABADO SATINADO

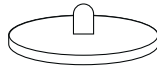
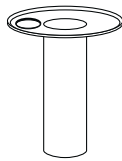
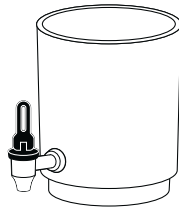
202884  
TUBE ACIER POUR GLACEICE TUBE STAINLESS STEEL  
TUBO PARA HIELO ACERO 18-10  
Ø 9 CM - 3 IN<sup>9/16</sup>202883  
FÛT CYLINDRIQUE URNECONTAINER FOR DISPENSER  
CONTENEDOR PARA EL DISPENSADOR SAN  
5L - 169 OZ<sup>1/16</sup>  
Ø 17,7 CM X H 25,5 CM  
Ø 6 IN<sup>5/16</sup> X H 10 IN<sup>1/16</sup>214724  
**ROBINET ACIER**  
STAINLESS STEEL FAUCET  
GRIFO ACERO  
+ ABS NOIR, BLACK, NEGRO

## BASE ACIER 18-10 URNE

STAINLESS STEEL STAND FOR DISPENSER 18-10  
SOPORTE ACERO PARA DISPENSADOR 18-10  
Ø 17,6 CM - H 19 CM  
Ø 6 IN<sup>5/16</sup> X H 7 IN<sup>1/2</sup>

202890	202889
<b>MIROIR</b>	<b>BROSSÉ</b>
MIRROR	BRUSHED
ACABADO BRILLO	ACABADO SATINADO

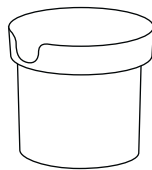
045963  
**GRILLE ACIER POUR GOUTTES - 18/10**  
STAINLESS STEEL GRID DROP COLLECTOR  
REJILLA DE ACERO PARA RECOGER EL GOTEIO  
Ø 9 CM - 3 IN<sup>9/16</sup>230758  
SOCLE NOIR ACRYLIQUE URNESTAND FOR BLACK DISPENSER  
BASE DEL DISPENSADOR NEGRO  
20 X 32 CM  
7 IN<sup>7/8</sup> X 12 IN<sup>5/8</sup>  
ÉPAISSEUR/ESPESOR : 2 CM  
THICKNESS: 13/16 IN

## DISTRIBUTEUR À CÉRÉALES

CEREALES DISPENSER - DISPENSADOR DE CEREALES

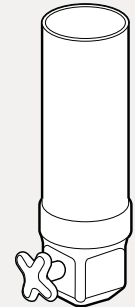
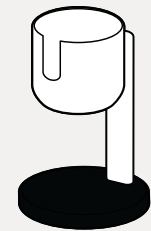
213078  
**COUVERCLE DISTRIBUTEUR CEREALES  
ACIER FINITION MIROIR - 18/10**  
LID FOR CEREAL DISPENSER, STAINLESS STEEL,  
MIRROR FINISH  
TAPA PARA DISPENSADOR EN BRILLO, ACERO  
Ø 12,5 CM - Ø 4 IN<sup>5/16</sup>213076  
FÛT CYLINDRIQUE AVEC AILETTE  
ET POIGNEE DISTRIBUTEUR CEREALESBARREL + HANDLE + ROLLING TAP  
FOR CEREAL DISPENSER  
CONTENEDOR PARA EL DISPENSADOR  
CON ALETA Y ASA  
P 16,1 X H 42 CM - D 6 IN<sup>5/16</sup> X H 16 IN<sup>9/16</sup>231301  
BASE + TUBE + SOCLE X1  
DISTRIBUTEUR À CEREALESSTAINLESS STEEL STAND + TUB  
+ ACRYLIC STAND FOR CEREAL DISPENSER  
BASE + TUBO + ZÓCALO DISPENSADOR  
DE CEREALES  
L 19 X H 27,5 CM - L 7 IN<sup>1/2</sup> X H 29 IN<sup>3/4</sup>231302  
BASE + TUBE + SOCLE X3  
DISTRIBUTEUR À CEREALES  
STAINLESS STEEL STAND + TUB  
+ ACRYLIC STAND FOR CEREAL DISPENSER  
BASE + TUBO + ZÓCALO  
X3 DISPENSADOR DE CEREALES  
L 50 X H 27,5 CM - L 19 IN<sup>10/16</sup> X H 29 IN<sup>3/4</sup>