

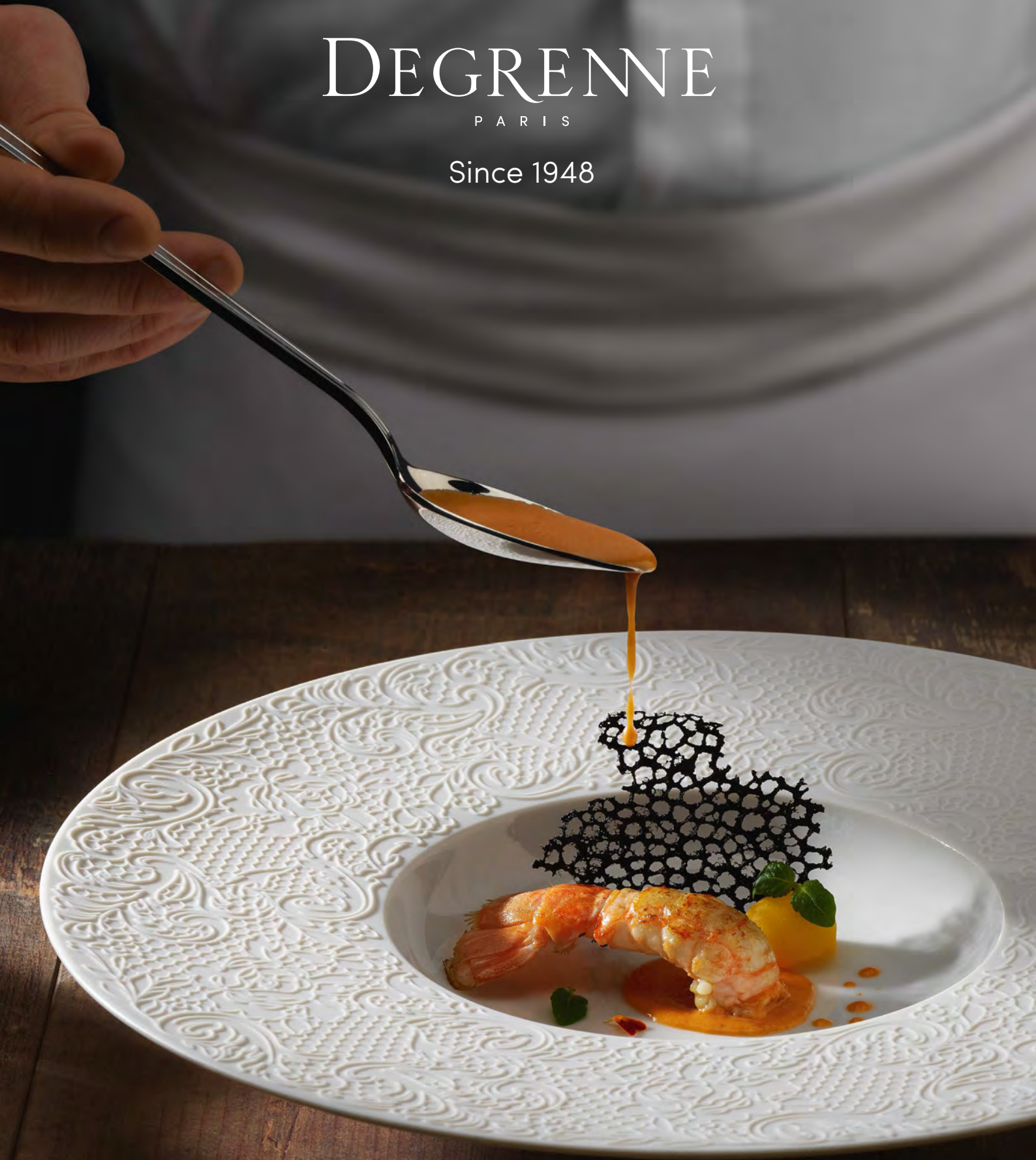

DEGRENNE

P A R I S

Since 1948



2020



DEGRENNÉ

P A R I S



DEGRENNÉ c'est l'histoire d'une formidable aventure humaine et industrielle. Née en 1948, elle a su traverser le temps et marquer les tables de son empreinte. 70 ans plus tard, la Maison DEGRENNE accompagne les hôteliers et les restaurateurs à travers le monde où la marque défend les belles valeurs de la Gastronomie et de l'Art de Vivre à la Française. Avec ses collections identitaires de couverts, vaisselle et verrerie, elle a l'honneur de s'inviter sur les plus belles tables pour sublimer les créations de chefs.

DEGRENNÉ est un fabricant français qui arbore avec fierté le label Entreprise du Patrimoine Vivant. C'est notamment dans ses usines de Vire et de Limoges, que ses artisans passionnés par les métiers de la porcelaine et de l'inox, perpétuent des savoir-faire transmis de génération en génération et sont toujours prêts à relever de nouveaux défis. Demain, DEGRENNE continuera plus que jamais à faire rayonner avec passion l'image de la France, à défendre ses savoir-faire et à cultiver l'esprit d'innovation, si fortement ancré dans son ADN, pour incarner le renouveau de l'Art de Vivre.

DEGRENNÉ Paris. L'Art de Vivre. Aujourd'hui & Demain.

DEGRENNÉ is the story of a fantastic human and industrial adventure. Founded in 1948, it has withstood the test of time and made its mark on the dining experience. Seventy years later, Maison DEGRENNE is supporting hoteliers and restaurateurs around the world, as a brand promoting the noble values of gastronomy and the French Art of Living. With its unmistakable collections of cutlery, tableware and glassware, it has the honour of setting off creations at the tables of the finest chefs.

DEGRENNÉ is a French manufacturer proud to have been named an "Entreprise du Patrimoine Vivant" (living heritage company). Especially in its factories of Vire and Limoges, its passionate porcelain and steel craftsmen perpetuate know-how passed down from generation to generation, and are always ready to take up new challenges. Looking to the future, DEGRENNE is more committed than ever to its passionate quest to promote the prestige of France, to champion its know-how and to cultivate the spirit of innovation so strongly rooted in its heritage, in order to embody a renaissance in the Art of Living.

DEGRENNÉ Paris. The Art of Living. Today & Tomorrow.

DEGRENNÉ es la historia de una formidable aventura humana e industrial. Desde su nacimiento en 1948, ha sabido perdurar y dejar huella en la mesa. Han pasado 70 años y la casa DEGRENNE sigue al lado de los profesionales de la hostelería y la restauración en todo el mundo, defendiendo los grandes valores de la gastronomía y el arte de vivir a la francesa. Con sus inconfundibles colecciones de cubertería, vajilla y cristalería, tiene el honor de invitarse a las mejores mesas para sublimar las creaciones culinarias.

DEGRENNÉ es un fabricante francés que ostenta con orgullo el sello de excelencia Entreprise du Patrimoine Vivant. Principalmente en sus instalaciones de Vire y Limoges, sus artesanos, apasionados por los oficios de la porcelana y el acero inoxidable, perpetúan técnicas transmitidas de generación en generación, siempre dispuestos a asumir nuevos desafíos. DEGRENNE mira al futuro para seguir transmitiendo con pasión la brillante imagen de Francia, defender su saber hacer y cultivar el espíritu de innovación, tan arraigado en su ADN, con el fin de encarnar la renovación del arte de vivir.

DEGRENNÉ Paris. El arte de vivir. Hoy y mañana.

Géraldine Hottier-Fayon
Présidente du groupe DEGRENNE



FAIRE NAITRE LES PLUS BELLES EMOTIONS!

Les collections DEGRENNE habillent les plus belles tables du monde et célèbrent **le renouveau de la Gastronomie Française et Internationale**. Elles inspirent les professionnels de l'hôtellerie et de la restauration pour **mettre en lumière leurs créations** et **sublimier le service à table**. Plus que des produits ce sont **de véritables outils de dégustation** créés pour **faire naître les plus belles émotions**.

CREATING BE MOST BEAUTIFUL EMOTIONS!

The DEGRENNE collections adorn the finest tables in the world and celebrate **the revival of French and international gastronomy**. They inspire professionals in the hotel and catering industry, **showcasing their creations** and **enhancing table service**. These are not simply products, they are **real tasting tools**, created **to stir the most uplifting emotions**.

¡DESPETAR LAS MÁS BELLAS EMOCIONES!

Las colecciones de DEGRENNE visten las mesas más hermosas del mundo y celebran **la renovación de la gastronomía francesa e internacional**. Inspiran a los profesionales de la hostelería y la restauración para dar **protagonismo a sus creaciones** y **sublimar el servicio de mesa**. Más que objetos son **auténticas herramientas de degustación** creadas para **despertar las más bellas emociones**.



©Emanuel Machado - Brasserie of Light, Selfridges - London, UK



©Vincent Ménager - STK London - London, UK



©Dominic Grundy - Panoramic 34 - Liverpool, UK



© Ana Grgić - Esplanade Zagreb Hotel - Restaurant Zinfandel's - Zagreb, HR



© Mike Reid - M Restaurant - London, UK



©Frédéric Don - Sketch - London, UK



©Vincent Ménager - STK London - London, UK



©Christian Tetedoie - Restaurant Tetedoie - Lyon, FR



HERITAGE
HERITAGE - LEGADO

P.07



DEGRENNÉ EN CHIFFRES
IN NUMBERS - EN CIFRAS

P.13



PARTENAIRES DE
L'EXCELLENCE
PARTNERS IN EXCELLENCE
SOCIOS DE LA EXCELENCIA

P.15



DEGRENNÉ DANS
LE MONDE
WORLDWIDE - EN EL MUNDO

P.17



RESTAU
RATEUR

FOOD SERVICE
RESTAURACIÓN

L'EXCELLENCE POUR
CHACUN DE VOS
BESOINS
EXCELLENCE FOR EACH OF YOUR NEEDS
EXCELENCIA PARA SATISFACER TODAS
SUS NECESIDADES

P.19



HOTE
LIER

HOSPITALITY
HOSTELERIA



LOU
EUR

CATERING
CATERING

LA VAISSELLE

DINNERWARE - VAJILLA

60-61	API
70-75	BAHIA NEW
44-47	BORÉAL
48-49	BORÉAL SATIN
68-69	COCOTTES
40-41	COLLECTION L
34-35	COLLECTION L COUTURE NEW
36-37	COLLECTION L FRAGMENT
38-39	COLLECTION L PERLES DE ROSÉE
62-63	ECLIPSE
64-65	ESSENTIELLE
42-43	GRAPHIQUE
50-53	LA VAISSELLE DE L'ECONOME NEW
56-59	MODULO
76-79	MODULO NATURE
80-81	MONDO
84-87	SALAM
88-89	SALAM THÉ
54-55	SMOOS

LA CAFÉTERIE

TEATIME - TÉ/CAFÉ

84-87	SALAM
88-89	SALAM THÉ
54-55	SMOOS

LES COUVERTS

FLATWARE - CUBIERTOS

COLLECTIONS

CLASSIQUES

140-141	ABSOLU
160-163	BLOIS
168-169	CONFIDENCE
146-147	FLORENCIA
158-159	LUTÈCE
148-149	MARQUISE
164-165	MIKADO MIROIR
166-167	MIKADO VINTAGE
150-151	MILADY
152-153	NEUJILLY
142-143	NORMANDY
124-125	ONDE
144-145	SQUADRO
154-157	VERLAINE
170-171	VIEUX PARIS SATINÉ

COLLECTIONS

DESIGN

132-133	ALOA
122-123	AQUATIC
128-129	ASTRÉE CISELÉ
126-127	ASTRÉE MIROIR
172-173	COUTEAUX À STEAK
118-119	FUSE NEW
120-121	FUSE MARTELÉ NEW
114-115	GUEST CUIVRE
110-111	GUEST MIROIR
112-113	GUEST STAR
116-117	GUEST VINTAGE
108-109	L'E STARCK ®
130-131	MIRAGE
172-173	MIRAGE LES ESSENCES
134-135	NORWAY
175	PETIT GOURMET
174	PIÈCES COMPLÉMENTAIRES
136-137	QUARTZ
104-105	SERENITY
106-107	SOLSTICE
102-103	XY BLACK MIROIR
100-101	XY MIROIR

LA PLATERIE

HOLLOWWARE - ORFEBRERÍA

188-189	ACCESSOIRES PLATERIE
186-187	NEWPORT BAR
184-185	NEWPORT CAFÉTERIE
180-181	NEWPORT CUBIQUE
178-179	NEWPORT PLATEAUX
182-183	NEWPORT SERVICE À TABLE
186-187	NEWPORT LOUNGE
178-179	NORMANDY

LA VERRERIE

GLASSWARE - CRISTALERÍA

214-215	ALLEGRO
210-211	ANYTIME
216-217	BILBAO
208-209	CARAFES
212-213	COSMOPOLITAIN
194-195	DANDY
208-209	DÉCANTEURS
214-215	DOLCE
202-203	DOMAINE
206-207	EMPILEO
192-193	HÉRITAGE NEW
204-205	HYPNOTIC
198-199	GALATÉE
212-213	LOOP
216-217	MAMBO
204-205	MONTMARTRE
196-197	MUSE
200-201	ORIGINE
210-211	VERRINES

LE BUFFET EVENTO

EVENTO BUFFET - BUFÉ EVENTO

236-237	ACCESSOIRES
220-223	CHAFING DISHES
230-231	DISTRIBUTEURS À CÉRÉALES
224-227	MODULES FROIDS
240-241	PIÈCES DÉTACHÉES
238-239	PLAN
232-233	SUPPORTS À FIL RECTANGULAIRES
234-235	SUPPORTS À FIL RONDS
228-229	URNES À JUS DE FRUITS

LA CUISINE

KITCHENWARE - COCINA

244-245	IDÉAL FORGÉ
246-247	L'ÉCONOME
248-249	NEWCOOK EXPERT

250-251

SERVICE REASSORT

REPLACEMENT PRODUCT SERVICE - SERVICIOS

250-259

SERVICE PERSONNALISATION

CUSTOM-MADE SERVICE - SERVICIO DE PERSONALIZACIÓN



LA NAISSANCE D'UNE GRANDE MAISON FRANÇAISE

Fondée en 1948, La Maison DEGRENNE est une **formidable histoire d'entrepreneuriat** portée par un homme visionnaire, Guy Degrenne, qui se lance dans la quête de **repenser les Arts de la Table** en démocratisant l'Orfèvrerie.

Clairvoyant, le jeune entrepreneur normand avait compris le potentiel de l'acier inoxydable pour fabriquer des couverts et avait perçu, dans la France d'après-guerre, le **désir de modernité**. Avec **audace, passion et détermination**, il allait marquer les tables de son empreinte et hisser son entreprise au rang de leader du marché.

Aujourd'hui, la Maison DEGRENNE s'attache toujours à **répondre aux envies de ses clients** avec ses collections de couverts, vaisselle, platerie, ou encore de verrerie.

Forte du **savoir-faire unique de ses artisans**, la marque s'inscrit dans son époque et cultive **l'esprit d'innovation**, si fortement ancré dans son ADN, pour incarner le **renouveau de l'Art de Vivre à la française** !

THE CREATION OF A GREAT FRENCH FIRM

Founded in 1948, La Maison DEGRENNE is a **fantastic story of entrepreneurship** started by Guy Degrenne, a visionary who embraced the quest **to reinvent tableware** by bringing high-end metalwork skills to everyday dining.

The far-sighted young entrepreneur from Normandy had understood the potential of stainless steel for manufacturing cutlery and perceived **the desire for modernity** in post-war France. With **boldness, passion and determination**, he would make his mark on the dining experience and develop his company to become a market leader.

Today, Maison DEGRENNE is still just as committed to **meeting the desires of its customers** with its collections of cutlery, dinnerware, flatware and glassware.

Building on the **unique expertise of its craftsmen**, the brand embraces modernity and cultivates the **spirit of innovation** so deeply rooted in its heritage, in order to embody a **renaissance in the French Art of Living!**

¡EL NACIMIENTO DE UNA GRAN CASA FRANCESA!

La casa DEGRENNE, fundada en 1948, es fruto de **una formidable historia de emprendimiento** impulsada por un visionario, Guy Degrenne, que se impuso la tarea de **transformar el arte de la mesa** y democratizar la orfebrería.

Este joven normando, resuelto y lúcido, supo entender el potencial del acero inoxidable para fabricar cubiertos y percibió el **deseo de modernidad** que se respiraba en la Francia de la posguerra. Con **audacia, pasión y determinación**, consiguió dejar su huella en las mesas y elevar su empresa a la categoría de líder del mercado.

Hoy, la casa DEGRENNE sigue dedicada a **satisfacer las necesidades de sus clientes** con sus colecciones de cubertería, vajilla, orfebrería y cristalería.

Gracias a la **excepcional maestría de sus artesanos**, la marca se adapta a los tiempos, sin dejar nunca de cultivar el **espíritu de innovación** que lleva anclado en su ADN, para reencarnar la **renovación del arte de vivir a la francesa**.



NOTRE PASSION :
VOUS INSPIRER



*Entreprise
du Patrimoine
Vivant*

*L'excellence
des savoir-faire
français*

Avec vous, nous désirons partager une véritable **Culture de l'art de vivre**. Quelque soit votre approche élégante, innovante, sobre ou luxuriante, la Maison DEGRENNE dessine pour vous les collections qui sauront conter votre cuisine : **courbes, matières, couleurs, chaque détail compte** pour souligner votre travail. Tout comme le vôtre, notre métier exige de **la rigueur et le sens du détail**. Nous avons la passion du «beau» pour vous inspirer le meilleur. Cette passion est initiée dès sa fondation, il y a 70 ans, par **Guy Degrenne**. Aujourd'hui, la Maison DEGRENNE arbore avec fierté le label **Entreprise du Patrimoine Vivant**, qui consacre l'excellence artisanale et industrielle française.

OUR PASSION: INSPIRING YOU

We wish to share a genuine **lifestyle culture** with you. Whatever your approach, whether elegant, innovative or luxurious, the Maison DEGRENNE will design collections for you, which will tell the story of your cuisine: **curves, materials, colours... every detail will enhance** your work. Just like you, our profession requires us to have **a strong work ethic and be detail-orientated**. We have a passion for the "beautiful" to inspire your best work. This passion was first generated, 70 years ago, by **Guy Degrenne**, when he created the company. Today, the Maison DEGRENNE proudly bears the "**Entreprise du Patrimoine Vivant**" (living heritage company) label, a testament of French artisanal and industrial excellence.

NUESTRA PASIÓN: INSPIRARLE

Deseamos compartir con usted una auténtica **cultura del disfrute de la vida**. Con independencia de que su oferta sea elegante, innovadora, sobria o lujosa, la firma DEGRENNE diseña colecciones a imagen y semejanza de su cocina: **curvas, materiales, colores... cada detalle cuenta** para realzar sus creaciones. Nuestra profesión, como la suya, **exige rigor y atención al detalle**. Nos apasiona lo bello para inspirarle mejor. Esta pasión se inició desde la fundación de la firma, hace setenta años, por **Guy Degrenne**. En la actualidad, la firma DEGRENNE exhibe con orgullo su certificación de **Entreprise du Patrimoine Vivant** (empresa del patrimonio vivo), que reconoce la excelencia artesanal e industrial francesa.



FIER DE NOS ARTISANS!

À Vire comme à Limoges, c'est l'excellence d'hommes et de femmes passionnés par leur métier, qui perpétuent **des savoir-faire transmis de génération en génération** et sont toujours prêts à **relever de nouveaux défis**. Chaque artisan contribue à notre histoire, chaque parcours témoigne de **la richesse de nos compétences**. Le souci de **la qualité, la rigueur technique et l'art du geste bien accompli** sont les critères d'exigences communs à tous.

PROUD OF OUR ARTISANS!

Both in Vire and Limoges, men and women who are passionate about their profession perpetuate the **savoir-faire that has been transmitted from generation to generation** and are always ready **to take on new challenges**. Each artisan contributes to our story and every pathway bears witness to **the wealth of our abilities**. We require each artisan to be devoted to **high quality, rigorous technique and well accomplished handiwork**.

¡ORGULLOSOS DE NUESTROS ARTESANOS!

Tanto en Vire como en Limoges, unos trabajadores apasionados por su oficio perpetúan **las tradiciones transmitidas de generación en generación**, siempre dispuestos a **superar nuevos desafíos**. Cada artesano contribuye a nuestra historia; cada recorrido da fe de la **riqueza de nuestras competencias**. La atención a la **calidad, el rigor técnico y el saber hacer** son nuestros criterios y exigencias comunes.





7,5

MILLIONS DE
PIÈCES PRODUITES
CHAQUE ANNÉE

MILLION PIECES PRODUCED
EACH YEAR

MILLONES DE PIEZAS
PRODUCIDAS CADA AÑO

1300

RÉFÉRENCES CHR

HORECA REFERENCES

REFERENCIAS CHR



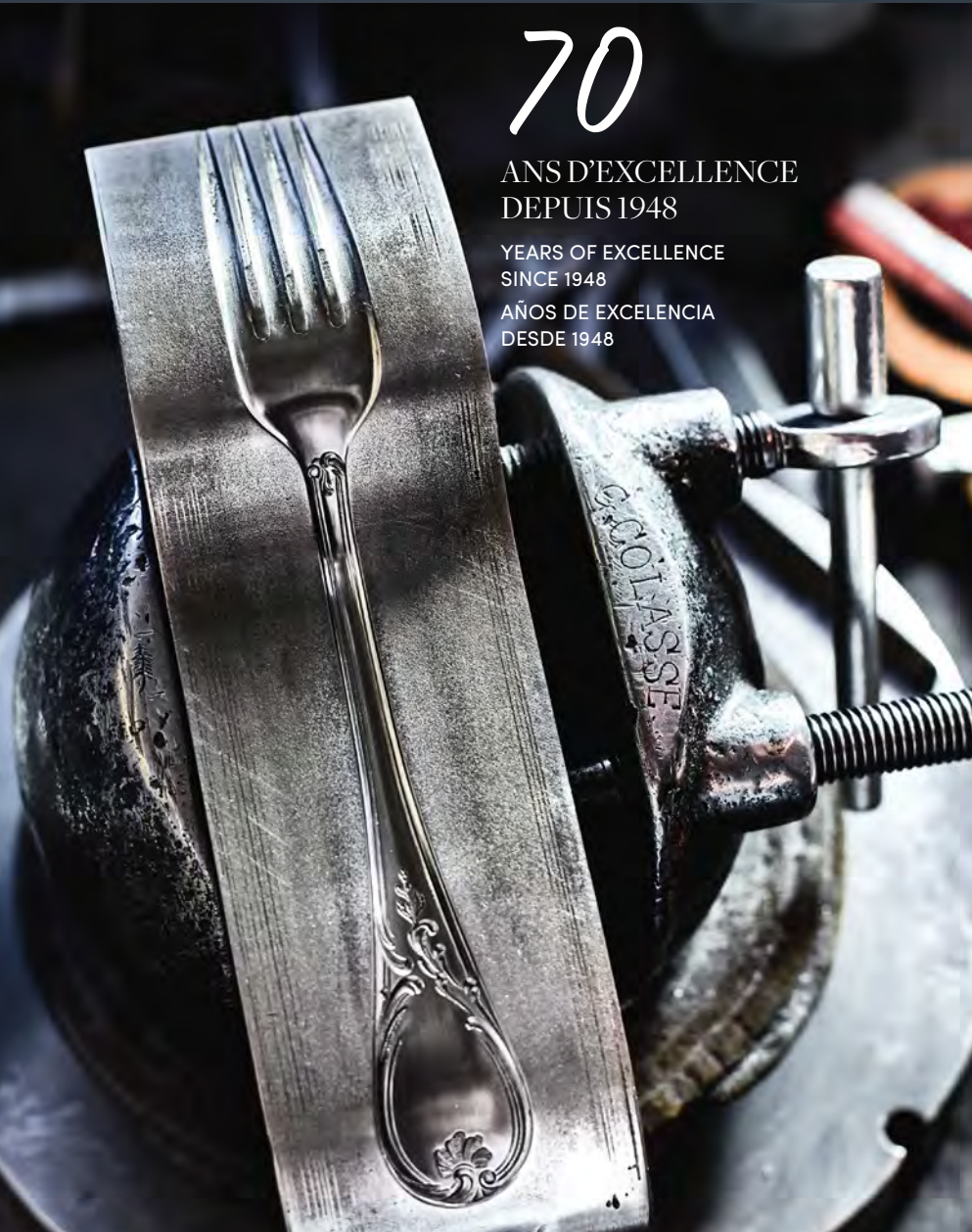

70

ANS D'EXCELLENCE
DEPUIS 1948

YEARS OF EXCELLENCE
SINCE 1948

AÑOS DE EXCELENCIA
DESDE 1948

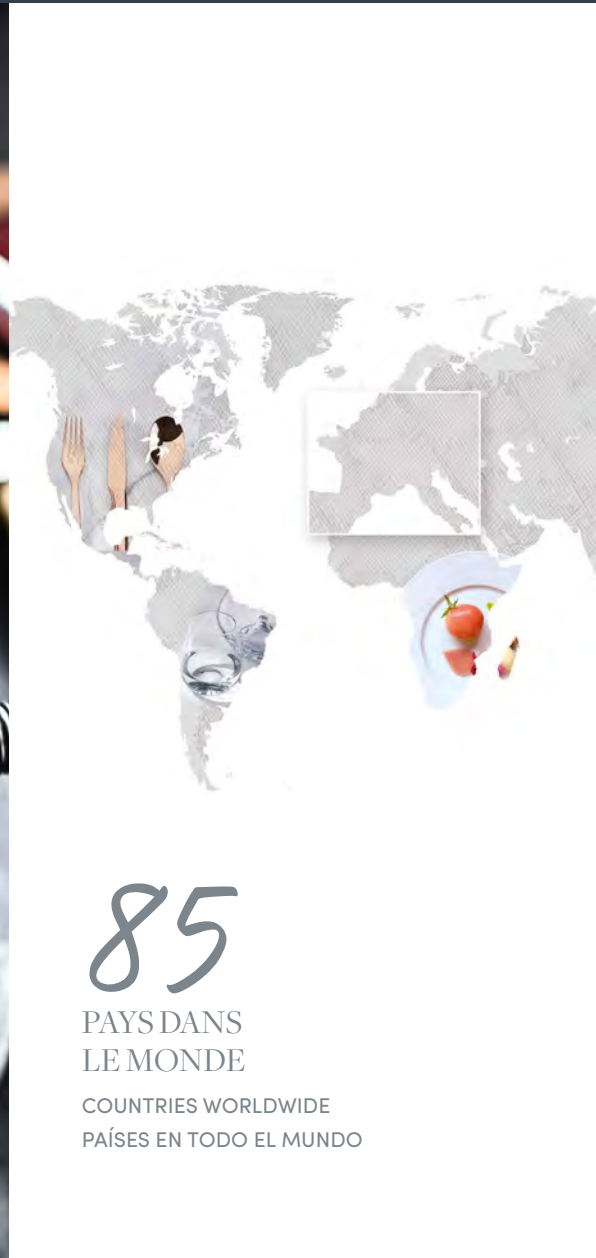

85

PAYS DANS
LE MONDE

COUNTRIES WORLDWIDE
PAÍSES EN TODO EL MUNDO



750

COLLABORATEURS

PARTNERS
EMPLEADOS

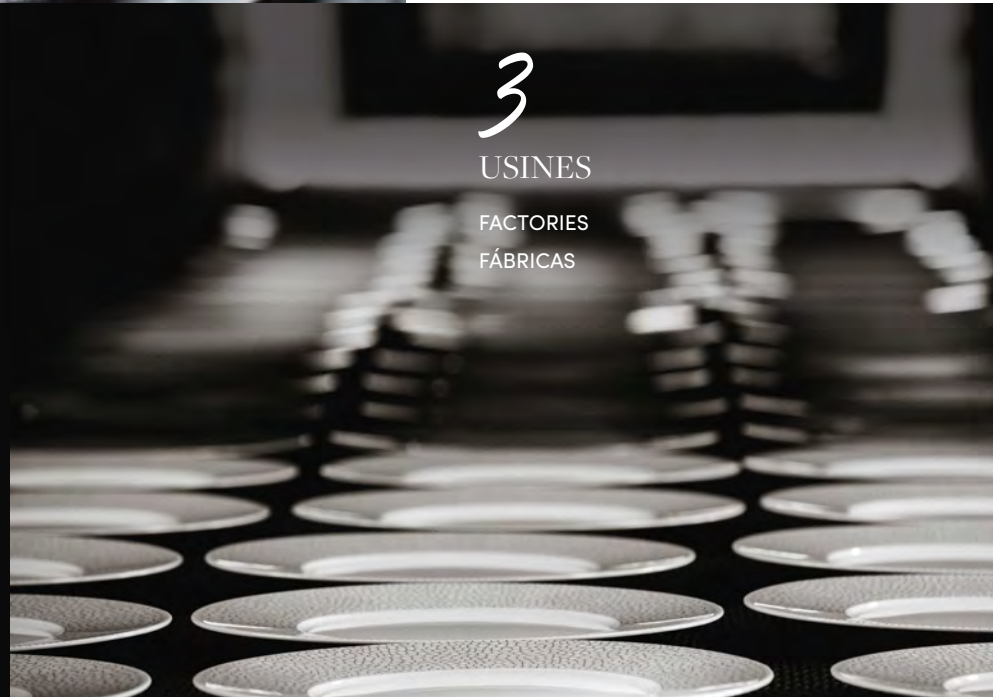

3

USINES

FACTORIES
FÁBRICAS



ILS NOUS FONT CONFIANCE

THEY TRUST US

NOS DEPOSITAN SU CONFIANZA

LE FOUQUETS
SOCIÉTÉ DES BAINS DE MER
LUTETIA
WALDORF ASTORIA
PENINSULA
PLAZA
ELEVEN MADISON PARK
BELLAGIO
MARRIOTT / STARWOOD / SHERATON
FOUR SEASONS
HILTON WORLDWIDE
ACCOR HOTELS
PULLMAN
SOÏTEL / BARRIÈRE
M GALLERY / MAMA SHELTER
NOVOTEL
MERCURE
IBIS
INTERCONTINENTAL
RITZ CARLTON
LOUVRE HOTELS
GOLDEN TULIP
CAMPANILE
KYRIAD
FAIRMONT / RAFFLES HOTELS
SWISSOTEL
W HOTELS



PARTENAIRES DE L'EXCELLENCE

PARTNERS IN EXCELLENCE
SOCIOS DE LA EXCELENCIA

LES CUISINIERS DE LA RÉPUBLIQUE
LES MAÎTRES CUISINIERS DE FRANCE
ACADÉMIE CULINAIRE DE FRANCE
CLUB DES DIRECTEURS DE LA RESTAURATION
ET DE L'EXPLOITATION
LES TOQUES BLANCHES LYONNAISES
COUPE GEORGES BAPTISTE
FERRANDI
L'ÉCOLE FRANÇAISE DE GASTRONOMIE
INSTITUT PAUL BOCUSE
ÉCOLE DE MANAGEMENT L'HOTELLERIE
RESTAURATION
GLION - SUISSE
INSTITUTE OF HIGHER EDUCATION
BEST
ÉCOLE DE BORDEAUX
AFLYHT
ASSOCIATION FRANÇAISE DES LYCÉES
D'HOTELLERIE ET DE TOURISME
LES TOQUES NORMANDES
ARYZTA FOOD SOLUTIONS
EURO TOQUES - SUISSE







2

SHOWROOMS



PARIS

NEW YORK

41 MADISON

3

SITES DE PRODUCTION ●

PRODUCTION SITES
PLANTAS DE PRODUCCIÓN

VIRE / FRANCE

COUVERTS ET PLATERIE
FLATWARE AND HOLLOWARE
CUBIERTOS E ORFEBRERÍA

LIMOGES / FRANCE

VAISSELLE
DINNERWARE
VAJILLA

ALFOLD / HONGRIE

VAISSELLE
DINNERWARE
VAJILLA





RESTAU RATEUR

FOOD SERVICE
RESTAURACION



HOTE LIER

HOSPITALITY
HOSTELERIA



LOU EUR

CATERING
CATERING

L'EXCELLENCE POUR CHACUN DE VOS BESOINS

DEGRENNÉ propose une gamme de produits d'art de la table inégalée et **adaptée aux besoins de chaque établissement**. Pour vous offrir les meilleurs produits, nous mettons **l'usage au cœur de nos réflexions** et cultivons **une identité qui nous est propre**. Choisis par de nombreux experts de la restauration à travers le monde, les produits DEGRENNÉ se distinguent par leur **excellence, fonctionnalité et élégance**.

EXCELLENCE FOR EACH OF YOUR NEEDS

DEGRENNÉ offers an unrivalled range of tableware products **adapted to the needs of each establishment**. To offer you the best products, **we focus on how our products will be used** and cultivate **our own unique identity**. Chosen by numerous leading restaurateurs around the world, DEGRENNÉ products stand out for their **excellence, functionality and elegance**.

EXCELENCIA PARA SATISFACER TODAS SUS NECESIDADES

DEGRENNÉ oferta una excepcional gama de productos para la mesa **adaptada a las necesidades de todos los establecimientos**. Nuestra norma de diseño es **darle prioridad al uso al tiempo** que cultivamos **una identidad propia**. Numerosos especialistas de la restauración de todo el mundo eligen los productos DEGRENNÉ por su **excelencia, funcionalidad y elegancia**.

L'EXCELLENCE CULINAIRE

CULINARY EXCELLENCE
LA EXCELENCIA CULINARIA

Parce que l'art du bon exige l'art du beau, nous développons des **collections de caractère**, d'une **qualité exceptionnelle** qui sublimeront vos mets délicats. Une invitation au plus beau voyage des sens...

Because excellent performance goes hand in hand with beauty, we develop **collections with character** and of **exceptional quality** that will exalt your delicate dishes – an invitation on the most beautiful journey of the senses...

Lo bueno es sinónimo de lo bello, por eso desarrollamos **colecciones con carácter**, con una **soberbia calidad** que realzará sus platos más delicados. Una invitación para disfrutar del mejor viaje sensorial...



- A** **L FRAGMENT**
227848 - ASSIETTE GOURMET P.36
SHALLOW BOWL - PLATO GOURMET
BAHIA
230944 - BOL COCOTTE P.68
ROUND CASSEROLE - BOL COCOTTE

- B** **L COUTURE**
237399 - ASSIETTE PLATE P.34
DINNER PLATE - PLATO REDONDO
237400 - ASSIETTE DESSERT P.34
DESSERT PLATE - PLATO REDONDO

- C** **L FRAGMENT**
227843 - ASSIETTE DE PRESENTATION P.36
PRESENTATION PLATE - PRESENTACION REDONDO

- COCOTTES**
234336 - ASSIETTE COCOTTE P.68
CASSEROLE PLATE - PLATO COCOTTE

B



L'EXCELLENCE POUR CHACUN DE VOS BESOINS
EXCELLENCE FOR EACH OF YOUR NEEDS - EXCELENCIA PARA SATISFACER TODAS SUS NECESIDADES

GASTRO NOMIE

HAUTE CUISINE
SEGMENTO ALTO



TRADITION REVISITEE

A NEW APPROACH TO TRADITION
LA TRADICIÓN ACTUALIZADA

Nos **formes et matières contemporaines** vous permettront d'exprimer toute **votre créativité** ! Elles souligneront une **cuisine inventive et gourmande** complice d'une nouvelle expérience culinaire dans un esprit de convivialité et de partage.

Our **contemporary designs and materials** will allow you to fully express **your creativity**! They will set off **inventive and delicious cuisine** that is part of a new culinary experience in a spirit of sociability and sharing.

¡Nuestras **formas y materiales contemporáneos** le permitirán expresar toda **su creatividad**! Son un medio para destacar **una cocina inventiva y exquisita**, cómplice de una nueva experiencia culinaria bajo el signo de la convivencia y el deseo de compartir.

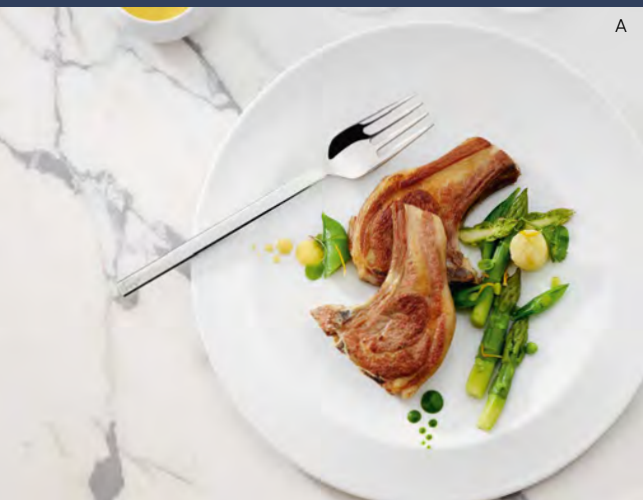

A



B

C

BISTRO NOMIE

BISTROS
SEGMENTO MEDIO



E

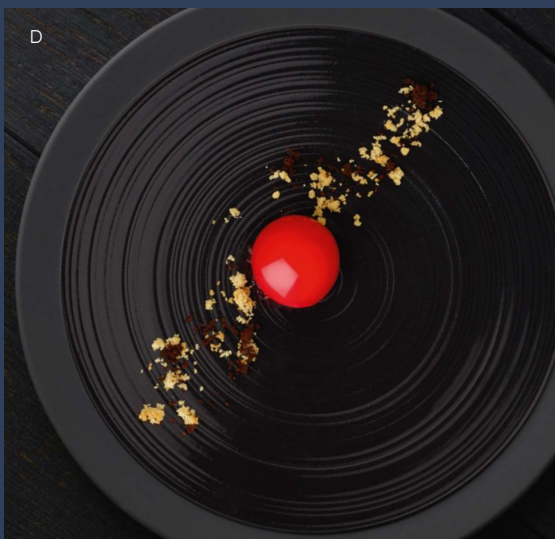

D



F

A L'E STARCK

233011 - FOURCHETTE DE TABLE P.108
TABLE FORK - TENEDOR DE MESA

B COCOTTES

230970, 230942, 230956 - BOL BISEAUTÉ
COCOTTE - SLANTED RIM BOWL - P.69
BOL BISEADO COCOTTE

C BORÉAL

207134 - ASSIETTE PLATE OVALE P.44
OVAL DINNER PLATE - PLATO OVAL

207136 - ASSIETTE CALOTTE P.44
SHALLOW BOWL - COUPE PLATE HONDO

D BAHIA ONYX

236548 - ASSIETTE PLATE P.70
DINNER PLATE - PLATO REDONDO

E L'E STARCK

237297 - ASSIETTE PLATE - ROUND DINNER
PLATE - PLATO REDONDO P.50

237334 - GRANDE ASSIETTE CREUSE RONDE LARGE
DEEP PLATE - PLATO REDONDO P.52

F MODULO NATURE

194457 - COUPE/CALOTTE - SALAD/CEREAL PLATE, DEEP
BOL P.76

PATRIMOINE CULINAIRE

CULINARY HERITAGE
PATRIMONIO CULINARIO

Générosité et authenticité constituent l'esprit de la Brasserie. Nos collections de produits, **épurés et pratiques**, se mettent **au service de votre carte** pour mettre en valeur avec simplicité ce patrimoine culinaire.

Generosity and authenticity are at the heart of the brasserie experience. Our **refined and functional** collections **enhance your menu** by showcasing this culinary heritage with simplicity.

La generosidad y la autenticidad constituyen el espíritu del segmento más accesible. Nuestras colecciones de productos, **sobrias y prácticas**, se ponen al servicio de su carta para dar protagonismo con sencillez a su patrimonio culinario.



- A SMOOS**
207766 - TASSE À EXPRESSO - EXPRESSO CUP - EXPRESSO TAZA P.92
161025 - SOUCOUBE - ESPRESSO SAUCER - ESPRESSO PLATO
- B ECLIPSE**
234607 - ASSIETTE PLATE - DINNER PLATE P.62
PLATO REDONDO
- C ECLIPSE**
234609 - ASSIETTE CREUSE CALOTTE - ROUND CEREAL PLATE - PLATO P.62
HONDO
- D ECLIPSE**
234604 - BOL À SALADE - SALAD BOWL - BOL DE ENSALADA P.62



L'EXCELLENCE POUR CHACUN DE VOS BESOINS
EXCELLENCE FOR EACH OF YOUR NEEDS - EXCELENCIA PARA SATISFACER TODAS SUS NECESIDADES

BRASSERIE

BRASSERIES
SEGMENTO BAJO



L'ART DE L'ACCUEIL

THE ART OF HOSPITALITY
EL ARTE DE RECIBIR

Tout au long de leur séjour, offrez une **expérience sur mesure à vos clients**. Nos **produits modulables** et aux **finitions délicates** sont adaptés aux besoins de chaque instant, pour **sublimer votre accueil**.

Offer your customers a **tailor-made experience** throughout their stay. Our **modular products** and **delicate finishes** are tailored to the needs of every moment to **heighten your guests' experience**.

Ofrezca una **experiencia personalizada** a sus clientes durante toda su estancia. Nuestros **productos modulables** de **acabados delicados** se adaptan a las necesidades de cualquier momento para **brindar una bienvenida de primera**.



- A MUSE/DOLCE/LOOP**
GOBELETS - TUMBLERS - VASOS P.212-214
- B EVENTO**
BUFFET EVENTO - EVENTO BUFFET - BUFÉ EVENTO P.218-241
- C NEWPORT**
207763 - VERSEUSE - COFFEE/TEA POT P.90
CAFETERA TETERA
213854 - CREMIER - CREAM JUG - LECHERA P.184
- D NEWPORT**
182614 - CLOCHE ASSIETTE - DOME COVER, STAINLESS STEEL P.188
CAMPANA
185022 - PLATEAU RECTANGULAIRE AVEC ANSES - RECTANGULAR P.178
SERVING TRAY WITH HANDLES - BANDEJA RECTANGULAR CON ASAS
- E NORMANDY**
232963 - FOURCHETTE DE TABLE - TABLE FORK P.142
TENEDOR DE MESA
232966 - COUTEAU DE TABLE - TABLE KNIFE - CUCHILLO DE MESA P.142
- L PERLES DE ROSÉE**
233923 - ASSIETTE PLATE - ROUND DINNER PLATE - P.38
PLATO REDONDO

L'EXCELLENCE POUR CHACUN DE VOS BESOINS
EXCELLENCE FOR EACH OF YOUR NEEDS - EXCELENCIA PARA SATISFACER TODAS SUS NECESIDADES



HOTELIER

HOSPITALITY
HOSTELERIA



L'ART DE LA RÉCEPTION

THE ART OF RECEPTION
EL ARTE DE LAS RECEPCIONES

Sublimer la magie des **instants précieux** en invitant à la lumière de la **journée** ou d'une **soirée** nos gammes de produits qui **célèbrent l'art du moment**.

Enhance the magic of **precious moments** by allowing our collections **to help you celebrate** an unforgettable **day or evening**.

Nuestras gamas de productos, que **celebran el arte del momento**, subliman el encanto de **los instantes más preciosos** a la luz del **día** o durante una **noche** mágica.



- A ANYTIME** P.210
184567 - FLUTE À CHAMPAGNE - CHAMPAGNE FLUTE
FLAUTA CHAMPÁN
- NEWPORT** P.186
184180 - SEAU À CHAMPAGNE 2 BOUTEILLES - CHAMPAGNE BUCKET
CHAMPAGNE BUCKET 2 BOTTLES - CHAMPANERA
- B LA VAISSELLE DE L'ECONOME BY STARCK** P.50-52
ASSIETTES PLATES RONDES 14 CM - DINNER PLATES 5 IN^{1/2} - PLATOS
REDONDO 14 CM
- C EVENTO** P.218 - 241
BUFFET EVENTO - EVENTO BUFFET - BUFÉ EVENTO
- D L FRAGMENT** P.36
227829 - TASSE LUNGO - COFFEE/TEA CUP - LUNGO TAZA
227850 - SOUCOUBE LUNGO - COFFEE/TEA SAUCER - LUNGO PLATO
- E HERITAGE** P.192
234103 VERRE À VIN ROUGE - RED WINE GLASS - COPA DE VINO
234104 VERRE À VIN BLANC - WHITE WINE GLASS - COPA DE VINO

L'EXCELLENCE POUR CHACUN DE VOS BESOINS
EXCELLENCE FOR EACH OF YOUR NEEDS - EXCELENCIA PARA SATISFACER TODAS SUS NECESIDADES



LOU EUR

CATERING
CATERING







VAISSELLE

DEGRENNE travaille les formes et les matières en portant une attention particulière aux **attentes des chefs**, tant esthétiques que dans l'usage. Pour faire de la table un moment dédié aux **plaisirs gastronomiques**, du plus simple au plus élaboré, DEGRENNE imagine **des collections uniques qui incarnent l'excellence et qui peuvent être associées entre elles**. En jouant sur les combinaisons, les contrastes, les formes, les couleurs et les matières, chaque mets trouve harmonieusement sa place à table, avec **élégance et sobriété**. **Matières nobles, lignes épurées**, épousez tous les savoir-faire DEGRENNE lorsque vous dressez votre table.

DINNERWARE

DEGRENNE develops shapes and materials, while paying careful attention to **chefs' practical usage** and aesthetic requirements. DEGRENNE designs **unique collections that are the very embodiment of excellence and can also be combined**, in order to make dining a moment of **culinary pleasure**, from the simplest to the most elaborate pleasures. Each dish harmoniously finds its rightful place on the table, with **simplicity and elegance**, thanks to the combinations, contrasts, shapes, colours and materials employed by DEGRENNE. Capitalize on DEGRENNE's extensive expertise when setting your table : we offer **sleek lines and the finest materials**.

VAJILLA

DEGRENNE trabaja las formas y los materiales prestando una atención particular a las **expectativas de los chefs**, tanto estéticas como de uso. Para convertir la mesa en un momento dedicado a los **placeres gastronómicos**, del más sencillo al más elaborado, DEGRENNE imagina **coleccionas únicas que encarnan la excelencia y que pueden combinarse entre sí**. Jugando con las combinaciones, los contrastes, las formas, los colores y los materiales, cada plato encuentra su lugar en la mesa con armonía, **elegancia y sobriedad**. **Materiales nobles, líneas depuradas**, elija todos los saber hacer de DEGRENNE a la hora de preparar su mesa.

L FRAGMENT
227847 - ASSIETTE GOURMET
DESSERT/SALAD/APP.PLATE W/WIDE RIM - PLATO REDONDO

P.36

BAHIA
230910 - BOL COCOTTE - ROUND CASSEROLE
BOL COCOTTE

P.68







MADE IN FRANCE

PORCELAIN DE LIMOGES ET EXCELLENCE

Alliez élégance et sobriété grâce à des matières nobles et des formes aux lignes épurées. **D'une blancheur et d'une opalescence remarquables, la Porcelaine de Limoges est symbole d'excellence et de pureté.**

LIMOGES PORCELAIN AND EXCELLENCE

Combine elegance and simplicity by harnessing the finest materials and sleek lines. **Stunning white and milkily iridescent Limoges porcelain is the epitome of excellence and purity.**

PORCELANA DE LIMOGES Y EXCELENCIA

Conjuga elegancia y sobriedad gracias a materiales nobles y formas con líneas depuradas. **De una blancura y una opalescencia destacables, la porcelana de Limoges es símbolo de excelencia y de pureza.**





237398
ASSIETTE DE PRÉSENTATION
ROUND PRESENTATION PLATE
W/WIDE RIM
PLATO PRESENTACIÓN REDONDO
EXT : 32 CM - 12 IN^{5/8}
INT : 19,5 CM - 7 IN^{11/16}

237399
ASSIETTE PLATE
ROUND DINNER PLATE
W/WIDE RIM
PLATO REDONDO
EXT : 28 CM - 11 IN
INT : 17 CM - 6 IN^{7/8}

237400
ASSIETTE DESSERT
ROUND DESSERT/SALAD/
APP.PLATE W/WIDE RIM
PLATO REDONDO
EXT : 24 CM - 9 IN^{7/16}
INT : 15 CM - 5 IN^{7/8}

237401
ASSIETTE À PAIN
ROUND BREAD & BUTTER
PLATE W/WIDE RIM
PLATO DE PAN REDONDO
EXT : 14 CM - 5 IN^{1/2}
INT : 9,5 CM - 3 IN^{3/4}

COMPATIBLE AVEC LES ASSIETTES COCOTTE P. 68-69
COMPATIBLE WITH THE CASSEPOLE PLATES P. 68-69
COMPATIBLE CON LOS PLATOS COCOTTE P. 68-69



237402
ASSIETTE GOURMET
ROUND SHALLOW BOWL W/WIDE RIM
PLATO GOURMET
EXT : 30 CM - 11 IN^{13/16}
INT : 14 CM - 5 IN^{1/2}

COMPATIBLE AVEC LES BOLS COCOTTE P. 68-69
COMPATIBLE WITH THE ROUND CASSEPOLES P. 68-69
COMPATIBLE CON LOS BOLES COCOTTE P. 68-69

PORCELAINE - PORCELAIN - PORCELANA

ASSIETTE/COUVERCLE
ROUND PLATE/CASSEROLE LID
BOL/PLATO RONDO PAN
12,5 CM - 4 IN^{15/16}

209384



209383
BLANC BRILLANT
BRIGHT WHITE
BLANCO BRILLANTE

209384



209720
BLANC SABLÉ
SANDY WHITE
BLANCO PURO

BOL COCOTTE
ROUND CASSEPOLE
BOL COCOTTE
14 CM - 5 IN^{1/2}
50 CL - 16 OZ^{15/16}

CÉRAMIQUE TEINTÉE MASSE - MASS COLORED CERAMIC
CERÁMICA COLORADO A TODA MESA

230820

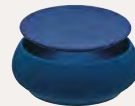

230821
BLEU
BLUE
AZUL

204042



204041
CARBONE
BLUE
GRIS

AUTRES COULEURS
OTHER COLORS
OTROS COLORES



COCOTTES P.68-69



237403
ASSIETTE GOURMET
ROUND SHALLOW BOWL W/WIDE RIM
PLATO GOURMET
EXT : 28 CM - 11 IN
INT : 11,5 CM - 4 IN^{1/2}

COMPATIBLE AVEC LES BOLS BISEAUTÉS COCOTTE P.68-69
COMPATIBLE WITH THE SLANTED RIM BOWLS P. 68-69
COMPATIBLE CON LOS BOLES BISEADOS COCOTTE P. 68-69

PORCELAINE - PORCELAIN - PORCELANA

BOL BISEAUTÉ COCOTTE
SLANTED RIM BOWL
BOL BISEADO COCOTTE
12 CM - 4 IN^{3/4}
30 CL - 10 OZ^{7/8}



186849
BLANC BRILLANT
BRIGHT WHITE
BLANCO BRILLANTE



211893
BLANC SABLÉ
SANDY WHITE
BLANCO PURO

CÉRAMIQUE TEINTÉE MASSE - MASS COLORED CERAMIC
CERÁMICA COLORADO A TODA MESA



230822
BLEU
BLUE
AZUL



234209
CARBONE
CARBONE/BLACK
NEGRO

AUTRES COULEURS
OTHER COLORS
OTROS COLORES



COCOTTES P. 68-69



182614
CLOCHE INOX
DOME COVER, STAINLESS STEEL
CAMPANA
24 CM - Ø 9 IN^{7/16}



182301
CLOCHE INOX
DOME COVER, STAINLESS STEEL
CAMPANA
14,8 CM - Ø 5 IN^{13/16}



206504
BOUCHON PORCELAINE
PORCELAIN LID
TAPA DE PORCELANA
5,2 CM - 2 IN^{1/16}

204043
CLOCHE VERRE BOROSILICATE
GLASS DOME COVER
CAMPANA VIDRIO BOROSILICATO
17X9 CM - 6 IN^{1/16} X 3 IN^{9/16}



227828
TASSE ESPRESSO
DEMITASSE CUP
ESPRESSO TAZA
10 CL - 3 OZ^{3/8}

237404
SOUCCOUE ESPRESSO
DEMITASSE SAUCER
ESPRESSO PLATO
12,6 CM - 4 IN^{15/16}



227829
TASSE LUNGO
COFFEE/TEA CUP
LUNGO TAZA
25 CL - 8 OZ^{7/16}

237405
SOUCCOUE LUNGO
COFFEE/TEA SAUCER
LUNGO PLATO
15,8 CM - 6 IN^{1/4}



©Patrick ROUGEREAU

Finedining

NEW COLLECTION L
COUTURE

Haute Porcelaine de Limoges
High Limoges Porcelain - Porcelana de Limoges

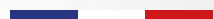
MADE IN FRANCE





227843
ASSIETTE DE PRÉSENTATION
ROUND PRESENTATION PLATE
W/WIDE RIM
PLATO PRESENTACIÓN REDONDO
EXT : 32 CM - 12 IN^{5/8}
INT : 19,5 CM - 7 IN^{11/16}

227844
ASSIETTE PLATE
ROUND DINNER PLATE
W/WIDE RIM
PLATO REDONDO
EXT : 28 CM - 11 IN
INT : 17 CM - 6 IN^{7/8}

227845
ASSIETTE DESSERT
ROUND DESSERT/SALAD/
APP.PLATE W/WIDE RIM
PLATO REDONDO
EXT : 24 CM - 9 IN^{7/16}
INT : 15 CM - 5 IN^{7/8}

227846
ASSIETTE À PAIN
ROUND BREAD & BUTTER
PLATE W/WIDE RIM
PLATO DE PAN REDONDO
EXT : 14 CM - 5 IN^{1/2}
INT : 9,5 CM - 3 IN^{3/4}

COMPATIBLE AVEC LES ASSIETTES COCOTTE P. 68-69
COMPATIBLE WITH THE CASSEROLE PLATES P. 68-69
COMPATIBLE CON LOS PLATOS COCOTTE P. 68-69



227847
ASSIETTE GOURMET
ROUND SHALLOW BOWL W/WIDE RIM
PLATO GOURMET
EXT : 30 CM - 11 IN^{13/16}
INT : 14 CM - 5 IN^{1/2}

COMPATIBLE AVEC LES BOLS COCOTTE P. 68-69
COMPATIBLE WITH THE ROUND CASSEROLES P. 68-69
COMPATIBLE CON LOS BOLES COCOTTE P. 68-69

PORCELAINE - PORCELAIN - PORCELANA

ASSIETTE/COUVERCLE
ROUND PLATE/CASSEROLE LID
BOL/PLATO RONDO PAN
12,5 CM - 4 IN^{15/16}

209384



209383
BLANC BRILLANT
BRIGHT WHITE
BLANCO BRILLANTE

209384



209720
BLANC SABLÉ
SANDY WHITE
BLANCO PURO

BOL COCOTTE
ROUND CASSEROLE
BOL COCOTTE
14 CM - 5 IN^{1/2}
50 CL - 16 OZ^{15/16}

CÉRAMIQUE TEINTÉE MASSE - MASS COLORED CERAMIC

CERÁMICA COLORADO A TODA MESA

230820

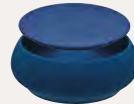

230821
BLEU
BLUE
AZUL

204042



204041
CARBONE
BLUE
GRIS

AUTRES COULEURS
OTHER COLORS
OTROS COLORES



COCOTTES P.68-69



227848
ASSIETTE GOURMET
ROUND SHALLOW BOWL W/WIDE RIM
PLATO GOURMET
EXT : 28 CM - 11 IN
INT : 11,5 CM - 4 IN^{1/2}

COMPATIBLE AVEC LES BOLS BISEAUTÉS COCOTTE P.68-69
COMPATIBLE WITH THE SLANTED RIM BOWLS P. 68-69
COMPATIBLE CON LOS BOLES BISEADOS COCOTTE P. 68-69

PORCELAINE - PORCELAIN - PORCELANA



186849
BLANC BRILLANT
BRIGHT WHITE
BLANCO BRILLANTE



211893
BLANC SABLÉ
SANDY WHITE
BLANCO PURO

BOL BISEAUTÉ COCOTTE
SLANTED RIM BOWL
BOL BISEADO COCOTTE
12 CM - 4 IN^{3/4}
30 CL - 10 OZ^{7/8}

CÉRAMIQUE TEINTÉE MASSE - MASS COLORED CERAMIC

CERÁMICA COLORADO A TODA MESA



230822
BLEU
BLUE
AZUL



234209
CARBONE
CARBONE/BLACK
NEGRO

AUTRES COULEURS
OTHER COLORS
OTROS COLORES



COCOTTES P. 68-69



182614
CLOCHE INOX
DOME COVER, STAINLESS STEEL
CAMPANA
24 CM - Ø 9 IN^{7/16}



182301
CLOCHE INOX
DOME COVER, STAINLESS STEEL
CAMPANA
14,8 CM - Ø 5 IN^{13/16}



206504
BOUCHON PORCELAINE
PORCELAIN LID
TAPA DE PORCELANA
5,2 CM - 2 IN^{1/16}

204043
CLOCHE VERRE BOROSILICATE
GLASS DOME COVER
CAMPANA VIDRIO BOROSILICATO
17X9 CM - 6 IN^{1/16} X 3 IN^{9/16}



227828
TASSE ESPRESSO
DEMITASSE CUP
ESPRESSO TAZA
10 CL - 3 OZ^{3/8}

227849
SOUCOUPE ESPRESSO
DEMITASSE SAUCER
ESPRESSO PLATO
12,6 CM - 4 IN^{15/16}



227829
TASSE LUNGO
COFFEE/TEA CUP
LUNGO TAZA
25 CL - 8 OZ^{7/16}

227850
SOUCOUPE LUNGO
COFFEE/TEA SAUCER
LUNGO PLATO
15,8 CM - 6 IN^{1/4}



Finedining

COLLECTION L FRAGMENT

Haute Porcelaine de Limoges
High Limoges Porcelain - Porcelana de Limoges

MADE IN FRANCE



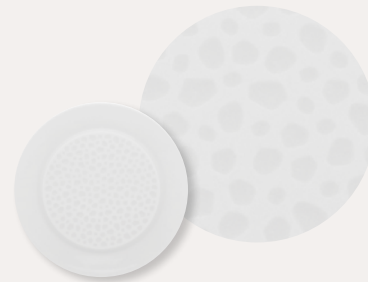

233922
ASSIETTE DE PRÉSENTATION
ROUND PRESENTATION PLATE
W/WIDE RIM
PLATO PRESENTACIÓN REDONDO
EXT : 32 CM - 12 IN^{5/8}
INT : 19,5 CM - 7 IN^{11/16}

233923
ASSIETTE PLATE
ROUND DINNER PLATE
W/WIDE RIM
PLATO REDONDO
EXT : 28 CM - 11 IN
INT : 17 CM - 6 IN^{7/8}

233924
ASSIETTE DESSERT
ROUND DESSERT/SALAD/
APP.PLATE W/WIDE RIM
PLATO REDONDO
EXT : 24 CM - 9 IN^{7/16}
INT : 15 CM - 5 IN^{7/8}

233925
ASSIETTE À PAIN
ROUND BREAD & BUTTER
PLATE W/WIDE RIM
PLATO DE PAN REDONDO
EXT : 14 CM - 5 IN^{1/2}
INT : 9,5 CM - 3 IN^{3/4}

COMPATIBLE AVEC LES ASSIETTES COCOTTE P. 68-69
COMPATIBLE WITH THE CASSEROLE PLATES P. 68-69
COMPATIBLE CON LOS PLATOS COCOTTE P. 68-69



233926
ASSIETTE GOURMET
ROUND SHALLOW BOWL W/WIDE RIM
PLATO GOURMET
EXT : 30 CM - 11 IN^{13/16}
INT : 14 CM - 5 IN^{1/2}

COMPATIBLE AVEC LES BOLS COCOTTE P. 68-69
COMPATIBLE WITH THE ROUND CASSEROLES P. 68-69
COMPATIBLE CON LOS BOLES COCOTTE P. 68-69

PORCELAINE - PORCELAIN - PORCELANA

ASSIETTE/COUVERCLE
ROUND PLATE/CASSEROLE LID
BOL/PLATO RONDO PAN
12,5 CM - 4 IN^{15/16}

209384



209383
BLANC BRILLANT
BRIGHT WHITE
BLANCO BRILLANTE

209384



209720
BLANC SABLÉ
SANDY WHITE
BLANCO PURO

BOL COCOTTE
ROUND CASSEROLE
BOL COCOTTE
14 CM - 5 IN^{1/2}
50 CL - 16 OZ^{15/16}

CÉRAMIQUE TEINTÉE MASSE - MASS COLORED CERAMIC
CERÁMICA COLORADO A TODA MESA

230820



230821
BLEU
BLUE
AZUL

204042



204041
CARBONE
BLUE
GRIS

AUTRES COULEURS
OTHER COLORS
OTROS COLORES



COCOTTES P.68-69



233927
ASSIETTE GOURMET
ROUND SHALLOW BOWL W/WIDE RIM
PLATO GOURMET
EXT : 28 CM - 11 IN
INT : 11,5 CM - 4 IN^{1/2}

COMPATIBLE AVEC LES BOLS BISEAUTÉS COCOTTE P.68-69
COMPATIBLE WITH THE SLANTED RIM BOWLS P. 68-69
COMPATIBLE CON LOS BOLES BISEADOS COCOTTE P. 68-69

PORCELAINE - PORCELAIN - PORCELANA

BOL BISEAUTÉ COCOTTE
SLANTED RIM BOWL
BOL BISEADO COCOTTE
12 CM - 4 IN^{3/4}
30 CL - 10 OZ^{1/8}



186849
BLANC BRILLANT
BRIGHT WHITE
BLANCO BRILLANTE



211893
BLANC SABLÉ
SANDY WHITE
BLANCO PURO



230822
BLEU
BLUE
AZUL



234209
CARBONE
CARBONE/BLACK
NEGRO

AUTRES COULEURS
OTHER COLORS
OTROS COLORES



COCOTTES P. 68-69



182614
CLOCHE INOX
DOME COVER, STAINLESS STEEL
CAMPANA
24 CM - Ø 9 IN^{7/16}



182301
CLOCHE INOX
DOME COVER, STAINLESS STEEL
CAMPANA
14,8 CM - Ø 5 IN^{13/16}



206504
BOUCHON PORCELAINE
PORCELAIN LID
TAPA DE PORCELANA
5,2 CM - 2 IN^{1/16}

204043
CLOCHE VERRE BOROSILICATE
GLASS DOME COVER
CAMPANA VIDRIO BOROSILICATO
17X9 CM - 6 IN^{1/16} X 3 IN^{9/16}



227828
TASSE ESPRESSO
DEMITASSE CUP
ESPRESSO TAZA
10 CL - 3 OZ^{3/8}

233928
SOUCCOPE ESPRESSO
DEMITASSE SAUCER
ESPRESSO PLATO
12,6 CM - 4 IN^{15/16}



227829
TASSE LUNGO
COFFEE/TEA CUP
LUNGO TAZA
25 CL - 8 OZ^{7/16}

233929
SOUCCOPE LUNGO
COFFEE/TEA SAUCER
LUNGO PLATO
15,8 CM - 6 IN^{1/4}



Finedining

COLLECTION L PERLES DE ROSÉE

Haute Porcelaine de Limoges
High Limoges Porcelain - Porcelana de Limoges

MADE IN FRANCE





227822
ASSIETTE DE PRÉSENTATION
ROUND PRESENTATION PLATE
W/WIDE RIM
PLATO PRESENTACIÓN REDONDO
EXT : 32 CM - 12 IN^{5/8}
INT : 19,5 CM - 7 IN^{11/16}

227823
ASSIETTE PLATE
ROUND DINNER PLATE
W/WIDE RIM
PLATO REDONDO
EXT : 28 CM - 11 IN
INT : 17 CM - 6 IN^{7/8}

227824
ASSIETTE DESSERT
ROUND DESSERT/SALAD/
APP.PLATE W/WIDE RIM
PLATO REDONDO
EXT : 24 CM - 9 IN^{7/8}
INT : 15 CM - 5 IN^{7/8}

232576
ASSIETTE CREUSE CALOTTE
ROUND CEREAL PLATE
PLATO HONDO
EXT : 18,5 CM - 7 IN^{5/8}

227825
ASSIETTE À PAIN
ROUND BREAD & BUTTER
PLATE W/WIDE RIM
PLATO DE PAN REDONDO
EXT : 14 CM - 5 IN^{1/2}
INT : 9,5 CM - 3 IN^{3/4}

COMPATIBLE AVEC LES ASSIETTES COCOTTE P. 68-69
COMPATIBLE WITH THE CASSEROLE PLATES P. 68-69
COMPATIBLE CON LOS PLATOS COCOTTE P. 68-69



227826
ASSIETTE GOURMET
ROUND SHALLOW BOWL W/WIDE RIM
PLATO GOURMET
EXT : 30 CM - 11 IN^{13/16}
INT : 14 CM - 5 IN^{1/2}

COMPATIBLE AVEC LES BOLS COCOTTE P. 68-69
COMPATIBLE WITH THE ROUND CASSEROLES P. 68-69
COMPATIBLE CON LOS BOLES COCOTTE P. 68-69

PORCELAINE - PORCELAIN - PORCELANA

ASSIETTE/COUVERCLE
ROUND PLATE/CASSEROLE LID
BOL/PLATO RONDO PAN
12,5 CM - 4 IN^{15/16}

209384



209383
BLANC BRILLANT
BRIGHT WHITE
BLANCO BRILLANTE

209384



209720
BLANC SABLÉ
SANDY WHITE
BLANCO PURO

BOL COCOTTE
ROUND CASSEROLE
BOL COCOTTE
14 CM - 5 IN^{1/2}
50 CL - 16 OZ^{15/16}

CÉRAMIQUE TEINTÉE MASSE - MASS COLORED CERAMIC
CERÁMICA COLORADO A TODA MESA

230820

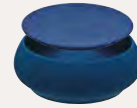

230821
BLEU
BLUE
AZUL

204042



204041
CARBONE
BLUE
GRIS

AUTRES COULEURS
OTHER COLORS
OTROS COLORES



COCOTTES P.68-69



227827
ASSIETTE GOURMET
ROUND SHALLOW BOWL W/WIDE RIM
PLATO GOURMET
EXT : 28 CM - 11 IN
INT : 14,5 CM - 4 IN^{1/2}

COMPATIBLE AVEC LES BOLS BISEAUTÉS COCOTTE P.68-69
COMPATIBLE WITH THE SLANTED RIM BOWLS P. 68-69
COMPATIBLE CON LOS BOLES BISEADOS COCOTTE P. 68-69

PORCELAINE - PORCELAIN - PORCELANA

BOL BISEAUTÉ COCOTTE
SLANTED RIM BOWL
BOL BISEADO COCOTTE
12 CM - 4 IN^{3/4}
30 CL - 10 OZ^{1/8}



186849
BLANC BRILLANT
BRIGHT WHITE
BLANCO BRILLANTE



211893
BLANC SABLÉ
SANDY WHITE
BLANCO PURO

CÉRAMIQUE TEINTÉE MASSE - MASS COLORED CERAMIC
CERÁMICA COLORADO A TODA MESA



230822
BLEU
BLUE
AZUL



234209
CARBONE
CARBONE/BLACK
NEGRO

AUTRES COULEURS
OTHER COLORS
OTROS COLORES



COCOTTES P. 68-69



182614
CLOCHE INOX
DOME COVER, STAINLESS STEEL
CAMPANA
24 CM - Ø 9 IN^{7/16}



182301
CLOCHE INOX
DOME COVER, STAINLESS STEEL
CAMPANA
14,8 CM - Ø 5 IN^{13/16}



206504
BOUCHON PORCELAINE
PORCELAIN LID
TAPA DE PORCELANA
5,2 CM - 2 IN^{1/16}

204043
CLOCHE VERRE BOROSILICATE
GLASS DOME COVER
CAMPANA VIDRIO BOROSILICATO
17X9 CM - 6 IN^{1/16} X 3 IN^{9/16}



227828
TASSE ESPRESSO
DEMITASSE CUP
ESPRESSO TAZA
10 CL - 3 OZ^{3/8}

227831
SOUCCOUE ESPRESSO
DEMITASSE SAUCER
ESPRESSO PLATO
12,6 CM - 4 IN^{15/16}



227829
TASSE LUNGO
COFFEE/TEA CUP
LUNGO TAZA
25 CL - 8 OZ^{7/16}

227832
SOUCCOUE LUNGO
COFFEE/TEA SAUCER
LUNGO PLATO
15,8 CM - 6 IN^{1/4}



Finedining

COLLECTION L

Haute Porcelaine de Limoges
High Limoges Porcelain - Porcelana de Limoges

MADE IN FRANCE





213936
ASSIETTE DE PRÉSENTATION
ROUND PRESENTATION PLATE
W/WIDE RIM
PLATO PRESENTACIÓN REDONDO
EXT : 32 CM - 12 IN^{5/8}
INT : 20 CM - 7 IN^{7/8}

213938
ASSIETTE PLATE
ROUND DINNER PLATE
W/WIDE RIM
PLATO REDONDO
EXT : 28 CM - 11 IN
INT : 17 CM - 6 IN^{11/16}

213940
ASSIETTE DESSERT
ROUND DESSERT/SALAD/
APP.PLATE W/WIDE RIM
PLATO REDONDO
EXT : 24 CM - 9 IN^{7/16}
INT : 15 CM - 5 IN^{7/8}

213942
ASSIETTE À PAIN
ROUND BREAD & BUTTER
PLATE W/WIDE RIM
PLATO DE PAN REDONDO
EXT : 14 CM - 5 IN^{1/2}
INT : 9,5 CM - 3 IN^{3/4}

COMPATIBLE AVEC LES ASSIETTES COCOTTE P. 68-69
COMPATIBLE WITH THE CASSEROLE PLATES P. 68-69
COMPATIBLE CON LOS PLATOS COCOTTE P. 68-69



222366
ASSIETTE GOURMET
ROUND SHALLOW BOWL W/WIDE RIM
PLATO GOURMET
EXT : 30 CM - 11 IN^{13/16}
INT : 14 CM - 5 IN^{1/2}

COMPATIBLE AVEC LES BOLS COCOTTE P. 68-69
COMPATIBLE WITH THE ROUND CASSEROLES P. 68-69
COMPATIBLE CON LOS BOLES COCOTTE P. 68-69

PORCELAINE - PORCELAIN - PORCELANA

ASSIETTE/COUVERCLE
ROUND PLATE/CASSEROLE LID
BOL/PLATO RONDO PAN
12,5 CM - 4 IN^{15/16}

209384



209383
BLANC BRILLANT
BRIGHT WHITE
BLANCO BRILLANTE

209384



209720
BLANC SABLÉ
SANDY WHITE
BLANCO PURO

BOL COCOTTE
ROUND CASSEROLE
BOL COCOTTE
14 CM - 5 IN^{1/2}
50 CL - 16 OZ^{15/16}

CÉRAMIQUE TEINTÉE MASSE - MASS COLORED CERAMIC
CERÁMICA COLORADO A TODA MESA

230820



230821
BLEU
BLUE
AZUL

204042



204041
CARBONE
BLUE
GRIS

AUTRES COULEURS
OTHER COLORS
OTROS COLORES



COCOTTES P.68-69



222365
ASSIETTE GOURMET
ROUND SHALLOW BOWL W/WIDE RIM
PLATO GOURMET
EXT : 28 CM - 11 IN
INT : 12 CM - 4 IN^{3/4}

COMPATIBLE AVEC LES BOLS BISEAUTÉS COCOTTE P.68-69
COMPATIBLE WITH THE SLANTED RIM BOWLS P. 68-69
COMPATIBLE CON LOS BOLES BISEADOS COCOTTE P. 68-69

PORCELAINE - PORCELAIN - PORCELANA

BOL BISEAUTÉ COCOTTE
SLANTED RIM BOWL
BOL BISEADO COCOTTE
12 CM - 4 IN^{3/4}
30 CL - 10 OZ^{1/8}



186849
BLANC BRILLANT
BRIGHT WHITE
BLANCO BRILLANTE



211893
BLANC SABLÉ
SANDY WHITE
BLANCO PURO

CÉRAMIQUE TEINTÉE MASSE - MASS COLORED CERAMIC
CERÁMICA COLORADO A TODA MESA



230822
BLEU
BLUE
AZUL



234209
CARBONE
CARBONE/BLACK
NEGRO

AUTRES COULEURS
OTHER COLORS
OTROS COLORES



COCOTTES P. 68-69



182614
CLOCHE INOX
DOME COVER, STAINLESS STEEL
CAMPANA
24 CM - Ø 9 IN^{7/16}



182301
CLOCHE INOX
DOME COVER, STAINLESS STEEL
CAMPANA
14,8 CM - Ø 5 IN^{13/16}



206504
BOUCHON PORCELAINE
PORCELAIN LID
TAPA DE PORCELANA
5,2 CM - 2 IN^{1/16}

204043
CLOCHE VERRE BOROSILICATE
GLASS DOME COVER
CAMPANA VIDRIO BOROSILICATO
17X9 CM - 6 IN^{1/16} X 3 IN^{9/16}



207756
TASSE ESPRESSO
DEMITASSE CUP
ESPRESSO TAZA
10 CL - 3 OZ^{3/8}

223406
SOUCCOPE ESPRESSO
DEMITASSE SAUCER
ESPRESSO PLATO
12,6 CM - 4 IN^{15/16}



207757
TASSE LUNGO
COFFEE/TEA CUP
LUNGO TAZA
20 CL - 6 OZ^{3/4}

223407
SOUCCOPE LUNGO
COFFEE/TEA SAUCER
LUNGO PLATO
15 CM - 5 IN^{7/8}



Finedining

GRAPHIQUE

Porcelaine
Porcelain - Porcelana





207137
ASSIETTE DE PRÉSENTATION
OVAL PRESENTATION PLATE
W/WIDE RIM
PLATO PRESENTACIÓN OVAL
EXT : 34,5 X 29 CM - 13 IN^{3/8} X 11 IN^{7/16}
INT : 20,5 CM - 8 IN^{1/16}

207134
ASSIETTE PLATE
OVAL DINNER PLATE
W/WIDE RIM
PLATO OVAL
EXT : 31 X 26,5 CM - 12 IN^{5/16} X 10 IN^{7/16}
INT : 18 CM - 7 IN^{1/16}

207135
ASSIETTE DESSERT
OVAL DESSERT PLATE
W/WIDE RIM
PLATO OVAL
EXT : 24 X 20,5 CM - 9 IN^{7/16} X 8 IN^{1/16}
INT : 14,5 CM - 5 IN^{5/16}

207139
ASSIETTE À PAIN
ROUND BREAD &
BUTTER PLATE
PLATO DE PAN REDONDO
EXT : 16 CM - 6 IN^{5/16}
INT : 10 CM - 3 IN^{15/16}

207140
ASSIETTE À PÂTES/SOUPÉ
ROUND SOUP/PASTA BOWL
W/WIDE RIM
PLATO HONDO PASTA REDONDO
EXT : 29,5 CM - 11 IN^{5/8}
INT : 17 CM - 6 IN^{11/16}

207136
ASSIETTE CALOTTE OVALE
OVAL SHALLOW BOWL, COUPE
PLATO HONDO OVAL
EXT : 23,5 X 20 CM - 9 IN^{1/4} X 7 IN^{7/8}



204040
ASSIETTE GOURMET OVALE GRAND BASSIN
SHALLOW BOWL W/WIDE OVAL RIM
PLATO GOURMET OVAL FONDO GRANDE
EXT : 32 X 27 CM - 12 IN^{5/8} X 10 IN^{5/8}
INT : 14,5 CM - 5 IN^{5/16}
27 CL - 9 OZ^{1/8}



207141
ASSIETTE GOURMET OVALE BASSIN PLAT
OVAL PLATE W/WIDE - RIM, FLAT
PLATO GOURMET OVAL
EXT : 30 X 26 CM - 11 IN^{13/16} X 10 IN^{1/4}
INT : 12 CM - 4 IN^{3/4}
COMPATIBLE AVEC LES BOLS COCOTTE P. 68-69
COMPATIBLE WITH THE ROUND CASSEROLES P. 68-69
COMPATIBLE CON LOS BOLES COCOTTE P. 68-69



207138
ASSIETTE GOURMET OVALE PETIT BASSIN
SHALLOW BOWL W/WIDE OVAL RIM
PLATO GOURMET OVAL PEQUEÑO
EXT : 30 X 26 CM - 11 IN^{13/16} X 10 IN^{1/4}
INT : 13,5 CM - 5 IN^{5/16}
17 CL - 5 OZ^{3/4}
COMPATIBLE AVEC LES BOLS BISEAUTÉS COCOTTE P.68-69
COMPATIBLE WITH THE SLANTED RIM BOWLS P. 68-69
COMPATIBLE CON LOS BOLES BISEADOS COCOTTE P. 68-69

PORCELAINE - PORCELAIN - PORCELANA

ASSIETTE/COUVERCLE
ROUND PLATE/CASSEROLE LID
BOL/PLATO RONDO PAN
12,5 CM - 4 IN^{15/16}

209384



209383
BLANC BRILLANT
BRIGHT WHITE
BLANCO BRILLANTE

209384



209720
BLANC SABLÉ
SANDY WHITE
BLANCO PURO

BOL COCOTTE
ROUND CASSEROLE
BOL COCOTTE
14 CM - 5 IN^{1/2}
50 CL - 16 OZ^{15/16}

CÉRAMIQUE TEINTÉE MASSE - MASS COLORED CERAMIC
CERÁMICA COLORADO A TODA MESA

230820

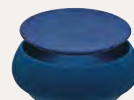

230821
BLEU
BLUE
AZUL

204042



204041
CARBONE
GREY
GRIS

AUTRES COULEURS
OTHER COLORS
OTROS COLORES



COCOTTES P.68-69

PORCELAINE - PORCELAIN - PORCELANA



186849
BLANC BRILLANT
BRIGHT WHITE
BLANCO BRILLANTE



211893
BLANC SABLÉ
SANDY WHITE
BLANCO PURO

BOL BISEAUTÉ COCOTTE
SLANTED RIM BOWL
BOL BISEADO COCOTTE
12 CM - 4 IN^{3/4}
30 CL - 10 OZ^{1/8}

CÉRAMIQUE TEINTÉE MASSE - MASS COLORED CERAMIC
CERÁMICA COLORADO A TODA MESA



230822
BLEU
BLUE
AZUL



234209
CARBONE
CARBONE/BLACK
NEGRO

AUTRES COULEURS
OTHER COLORS
OTROS COLORES



COCOTTES P.68-69



182614
CLOCHE INOX
DOME COVER, STAINLESS STEEL
CAMPANA
24 CM - Ø 9 IN^{7/16}



182301
CLOCHE INOX
DOME COVER, STAINLESS STEEL
CAMPANA
14,8 CM - Ø 5 IN^{13/16}



206504
BOUCHON PORCELAINE
PORCELAIN LID
TAPA DE PORCELANA
5,2 CM - 2 IN^{1/16}

204043
CLOCHE VERRE BOROSILICATE
GLASS DOME COVER
CAMPANA VIDRIO BOROSILICATO
17X9 CM - 6 IN^{11/16} X 3 IN^{9/16}



Finedining

BORÉAL

Porcelaine
Porcelain - Porcelana





186782
SALADIER
SALAD BOWL DEEP
ENSALADERA
28 X 24 CM - 11 IN X 9 IN^{7/16}
H : 11 CM - 4 IN^{5/16}



186779
COUPELLE
DEEP BOWL, SMALL
BOL
14 X 12 CM - 5 IN^{1/2} X 4 IN^{3/4}
H : 5 CM - 4 IN^{5/16}



186797
VERRINE
RAMEKIN
VASO
6 CL - 2 OZ
H : 5,5 CM - 2 IN^{3/16}



186851
VERRINE
RAMEKIN
VASO
12 CL - 4 OZ^{1/16}
H : 7 CM - 2 IN^{3/4}

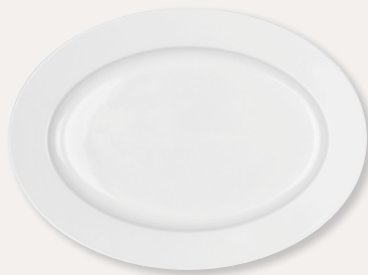

200102
PLAT OVAL CREUX
OVAL CHOP PLATE W/RIM, FLAT
PLATO HONDO OVALADO
EXT : 36,5 X 26,5 CM - 14 IN^{3/8} X 10 IN^{7/16}
INT : 26 X 17 CM - 10 IN^{1/4} X 6 IN^{11/16}



186788
PLAT À CAKE
OVAL LONG DISH W/WIDE RIM, FLAT
FUENTE OVALADO
EXT : 40,5 X 19 CM - 15 IN^{5/16} X 7 IN^{1/2}

NEWPORT CAFÉTERIE - TEATIME - TÉ CAFÉ



207756
TASSE ESPRESSO
DEMITASSE CUP
ESPRESSO TAZA
10 CL - 3 OZ^{3/8}



207757
TASSE LUNGO
COFFEE/TEA CUP
LUNGO TAZA
20 CL - 6 OZ^{3/4}



207758
TASSE DÉJEUNER
BREAKFAST CUP
TAZA DESAYUNO
40 CL - 13 OZ^{1/2}

207759
SOUCOUPE ESPRESSO
DEMITASSE SAUCER
ESPRESSO PLATO
12,5 CM - 4 IN^{5/16}

207760
SOUCOUPE LUNGO
COFFEE/TEA SAUCER
LUNGO PLATO
15,8 CM - 5 IN^{7/8}

207761
SOUCOUPE DÉJEUNER
BREAKFAST SAUCER
PLATO DESAYUNO
18 CM - 7 IN^{7/16}



207763
VERSEUSE
COFFEE/TEA POT
CAFETERA/TETERA
40 CL - 13 OZ^{1/2}



207764
VERSEUSE
COFFEE/TEA POT
CAFETERA/TETERA
80 CL - 27 OZ^{1/16}



207762
CRÉMIER
CREAM JUG
LECHERA
10 CL - 3 OZ^{3/8}



COUVERCLES VERSEUSES
LIDS FOR TEA POTS
TAPAS CAFETERAS

210911 210912
6,6 CM - 2 IN^{5/8} 8,4 CM - 3 IN^{5/16}
40 CL - 13 OZ^{1/2} 80 CL - 27 OZ^{1/16}



Finedining

BORÉAL

Porcelaine
Porcelain - Porcelana





193319
ASSIETTE DE PRÉSENTATION
ROUND PRESENTATION PLATE
W/WIDE RIM
PLATO PRESENTACIÓN REDONDO
EXT : 33 CM - 13 IN
INT : 20 CM - 7 IN^{7/8}

193318
ASSIETTE PLATE
ROUND DINNER PLATE
W/WIDE RIM
PLATO REDONDO
EXT : 28,5 CM - 11 IN^{1/4}
INT : 18,5 CM - 7 IN^{5/16}

193320
ASSIETTE DESSERT
ROUND DESSERT/PLATE
W/WIDE RIM
PLATO ILANO REDONDO
EXT : 22,5 CM - 8 IN^{7/8}
INT : 14,5 CM - 5 IN^{11/16}

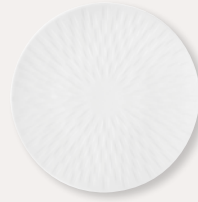

202470
ASSIETTE À PAIN
ROUND BREAD & BUTTER
PLATE W/WIDE RIM
PLATO DE PAN REDONDO
EXT : 15 CM - 5 IN^{7/8}



223954
ASSIETTE À PÂTES/SOUBE
ROUND SOUP/PASTA BOWL
W/WIDE RIM
PLATO HONDO PASTA REDONDO
EXT : 29 CM - 11 IN^{7/16}
INT : 16 CM - 6 IN^{5/16}



207769
ASSIETTE GOURMET OVALE GRAND BASSIN
SHALLOW BOWL W/WIDE OVAL RIM
PLATO GOURMET OVAL FONDO GRANDE
EXT : 32 X 27 CM - 12 IN^{5/8} X 10 IN^{3/8}
INT : 14 CM - 5 IN^{1/2}
27 CL - 9 OZ^{1/8}
COMPATIBLE AVEC LES BOLS COCOTTE P. 68-69
COMPATIBLE WITH THE ROUND CASSEROLES P. 68-69
COMPATIBLE CON LOS BOLES COCOTTE P. 68-69

PORCELAINE - PORCELAIN - PORCELANA

ASSIETTE/COUVERCLE
ROUND PLATE/CASSEROLE LID
BOL/PLATO RONDO PAN
12,5 CM - 4 IN^{15/16}

209384



209383
BLANC BRILLANT
BRIGHT WHITE
BLANCO BRILLANTE

209384



209720
BLANC SABLÉ
SANDY WHITE
BLANCO PURO

BOL COCOTTE
ROUND CASSEROLE
BOL COCOTTE
14 CM - 5 IN^{1/2}
50 CL - 16 OZ^{15/16}

CÉRAMIQUE TEINTÉE MASSE - MASS COLORED CERAMIC
CERÁMICA COLORADO A TODA MESA

230820

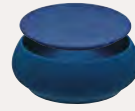

230821
BLEU
BLUE
AZUL

204042



204041
CARBONE
GREY
GRIS

AUTRES COULEURS
OTHER COLORS
OTROS COLORES



COCOTTES P.68-69



193324
ASSIETTE GOURMET OVALE PETIT BASSIN
SHALLOW BOWL W/WIDE OVAL RIM
PLATO GOURMET OVAL FONDO PEQUEÑO
EXT : 30 X 26 CM - 11 IN^{13/16} X 10 IN^{1/4}
INT : 12 CM - 4 IN^{3/4}
17 CL - 5 OZ^{3/4}
COMPATIBLE AVEC LES BOLS BISEAUTÉS COCOTTE P.68-69
COMPATIBLE WITH THE SLANTED RIM BOWLS P. 68-69
COMPATIBLE CON LOS BOLES BISEADOS COCOTTE P. 68-69

PORCELAINE - PORCELAIN - PORCELANA



186849
BLANC BRILLANT
BRIGHT WHITE
BLANCO BRILLANTE



211893
BLANC SABLÉ
SANDY WHITE
BLANCO PURO

BOL BISEAUTÉ COCOTTE
SLANTED RIM BOWL
BOL BISEADO COCOTTE
12 CM - 4 IN^{3/4}
30 CL - 10 OZ^{1/8}

CÉRAMIQUE TEINTÉE MASSE - MASS COLORED CERAMIC
CERÁMICA COLORADO A TODA MESA



230822
BLEU
BLUE
AZUL



234209
CARBONE
CARBONE/BLACK
NEGRO

AUTRES COULEURS
OTHER COLORS
OTROS COLORES



COCOTTES P.68-69



182614
CLOCHE INOX
DOME COVER, STAINLESS STEEL
CAMPANA
24 CM - Ø 9 IN^{7/16}

182301
CLOCHE INOX
DOME COVER, STAINLESS STEEL
CAMPANA
14,8 CM - Ø 5 IN^{13/16}



206504
BOUCHON PORCELAINE
PORCELAIN LID
TAPA DE PORCELANA
5,2 CM - 2 IN^{1/16}
204043
CLOCHE VERRE BOROSILICATE
GLASS DOME COVER
CAMPANA VIDRIO BOROSILICATO
17X9 CM - 6 IN^{11/16} X 3 IN^{9/16}



Finedining

BORÉAL SATIN

Porcelaine
Porcelain - Porcelana



VERT ARTICHAUT - GREEN ARTICHOKE - VERDE ALCAFOCHA



237295
237296
237297
237298



237299
237300
237301



237302
237303



237304

BLANC NAVET - WHITE TURNIP - BLANCO NABO



237315
237316
237317
237318



237319
237320
237321



237322
237323



237324

JAUNE GINGEMBRE - GINGER YELLOW - JENGIBRE AMARILLO



237285
237286
237287
237288



237289
237290
237291



237292
237293



237294

ASSIETTE PLATE RONDE

ROUND DINNER PLATE
PLATO REDONDO
14 CM - 5 IN^{1/2}
18 CM - 7 IN^{1/8}
24 CM - 9 IN^{7/16}
26 CM - 10 IN^{1/4}

BOL DROIT

STRAIGHT BOWL
BOL DERECHO
14 CM - 5 IN^{1/2}
50 CL - 16 OZ^{15/16}
18 CM - 7 IN^{1/16}
1,3 L - 43 OZ^{15/16}
24 CM - 9 IN^{7/16}
2,6 L - 87 OZ^{15/16}

BOL COUPE

FOOTED BOWL
BOL
14 CM - 5 IN^{1/2}
47 CL - 15 OZ^{7/8}
18 CM - 7 IN^{1/16}
90 CL - 30 OZ^{7/16}

GRANDE ASSIETTE

CREUSE RONDE
LARGE DEEP PLATE
GRANDE PLATO HONDO
24 CM - 9 IN^{7/16}
1,3 L - 43 OZ^{15/16}



Finedining

NEW LA VAISSELLE
DE L'ÉCONOME

Porcelaine
Porcelain - Porcelana



RADIS ROSE - PINK RADISH - RÁBANO ROSADO



237325
237326
237327
237328



237329
237330
237331



237332
237333



237334

GRIS RUTABAGA - GREY RUTABAGA - COLINABO GRIS



237305
237306
237307
237308



237309
237310
237311



237312
237313



237314

ASSIETTE PLATE RONDE

ROUND DINNER PLATE
PLATO REDONDO
14 CM - 5 IN^{1/2}
18 CM - 7 IN^{7/16}
24 CM - 9 IN^{7/16}
26 CM - 10 IN^{1/4}

BOL DROIT

STRAIGHT BOWL
BOL DERECHO
14 CM - 5 IN^{1/2}
50 CL - 16 OZ^{15/16}
18 CM - 7 IN^{1/16}
1,3 L - 43 OZ^{15/16}
24 CM - 9 IN^{7/16}
2,6 L - 87 OZ^{15/16}

BOL COUPE

FOOTED BOWL
BOL
14 CM - 5 IN^{1/2}
47 CL - 15 OZ^{7/8}
18 CM - 7 IN^{1/16}
90 CL - 30 OZ^{7/16}

GRANDE ASSIETTE CREUSE RONDE

LARGE DEEP PLATE
GRANDE PLATO HONDO
24 CM - 9 IN^{7/16}
1,3 L - 43 OZ^{15/16}



237337

CENTRE DE TABLE ROND⁽¹⁾

ROUND CENTER DISH
CENTRO DE MESA
28 CM - 11 IN

⁽¹⁾NON COMPATIBLE LAVE-VAISSELLE ET MICRO-ONDES
DONT USE WITH DISH WASHER AND MICRO-WAVE
NO VA EN EL LAVA-VAJILLAS AND EL MICRO-ONDAS



Finedining

NEW LA VAISSELLE
DE L'ÉCONOME

Porcelaine
Porcelain - Porcelana





161009
ASSIETTE PLATE
PRESENTATION PLATE
PLATO PRESENTACION
EXT : 28 CM - 11 IN
INT : 21 CM - 8 IN^{1/4}



161038
ASSIETTE À PAIN
ROUND BREAD & BUTTER PLATE
PLATO DE PAN REDONDO
EXT : 16 CM - 6 IN^{5/16}
INT : 13 CM - 5 IN^{1/8}



161012
ASSIETTE CREUSE
SHALLOW COUPE BOWL, LARGE
PLATO HONDO
EXT : 30 CM - 11 IN^{13/16}
INT : 26 CM - 10 IN^{1/4}

161011
ASSIETTE CREUSE
SHALLOW COUPE BOWL, MEDIUM
PLATO HONDO
EXT : 23 CM - 9 IN^{1/16}
INT : 20 CM - 7 IN^{7/8}



161016
SALADIER
DEEP BOWL, LARGE
ENSALADERA
32 CM - 12 IN^{5/8}
CONTENANCE : 250 CL
CAPACITY : 84 OZ^{3/16}
H : 14 CM - 5 IN^{1/2}



161015
SALADIER
DEEP BOWL, MEDIUM
ENSALADERA
25 CM - 9 IN^{3/16}
CONTENANCE : 150 CL
CAPACITY : 50 OZ^{3/4}
H : 11,5 CM - 4 IN^{1/4}



161014
SALADIER/BOL
DEEP BOWL, INDIVIDUAL
BOL
16,5 CM - 6 IN^{1/2}
CONTENANCE : 50 CL
CAPACITY : 16 OZ^{5/16}
H : 9 CM - 3 IN^{5/16}



161013
SALADIER/BOL
DEEP BOWL, CUP
BOL
9 CM - 3 IN^{9/16}
CONTENANCE : 20 CL
CAPACITY : 6 OZ^{3/4}
H : 7 CM - 2 IN^{8/16}



161020
COQUETIER
EGG CUP, PLATE
HUEVERA
15 CM - 5 IN^{7/8}



161037
RAVIER
SHALLOW RAMEKIN, COUPE
BOL
10 CM - 3 IN^{5/16}
H : 4 CM - 1 IN^{3/8}



198017
POT À SAUCE/GARNITURE
RAMEKIN, LARGE
POT
48 CL - 16 OZ^{1/4}
Ø 10,5 CM - 4 IN^{1/8}
H : 8 CM - 2 IN^{11/16}



198016
POT À SAUCE/GARNITURE
RAMEKIN, SUGAR BOWL
POT
20 CL - 6 OZ^{3/4}
Ø 8 CM - 3 IN^{1/8}
H : 7 CM - 2 IN^{9/16}



196561
POT À SAUCE/GARNITURE
RAMEKIN, SMALL
POT
7,5 CL - 2 OZ^{9/16}
Ø 5,5 CM - 2 IN^{3/16}
H : 6,5 CM - 2 IN^{9/16}



214688
SOUCOUBE UNIVERSELLE
UNIVERSAL SAUCER CUP
PLATO UNIVERSAL
13 CM - 5 IN^{1/8}



161036
SUPPORT PLATEAU
TRAY STAND, 3 PLACES
FUENTE CON 3 ESPACIOS
30,5 X 10 CM - 12 IN X 3 IN^{5/16}



207766
TASSE À ESPRESSO
ESPRESSO CUP
ESPRESSO DE TAZA
6 CL - 2 OZ



208948
TASSE À CAFÉ
DEMITASSE CUP
TAZA DE CAFÉ
11 CL - 3 OZ^{3/4}



207768
TASSE À DÉJEUNER
BREAKFAST CUP
TAZA DESAYUNO
48 CL - 16 OZ^{1/4}



207765
MUG
MUG, LARGE
MUG
50 CL - 16 OZ^{15/16}

209189
MUG
MUG
MUG
30 CL - 10 OZ^{1/8}

161025
SOUCOUBE À CAFÉ/ ESPRESSO
DEMITASSE/ESPRESSO SAUCER
ESPRESSO DE PLATO
15 CM - 5 IN^{7/8}

161028
SOUCOUBE À THÉ/LUNGO
COFFEE/TEA SAUCER
LUNGO DE PLATO
18 CM - 7 IN^{1/16}

161034
SOUCOUBE À DÉJEUNER
BREAKFAST SAUCER
PLATO DESAYUNO
21 CM - 8 IN^{1/4}



Alldaydining

SMOOS

Porcelaine
Porcelain - Porcelana



BLANC ROND - ROUND WHITE - BLANCO REDONDO



- | | | | | | | | |
|---|---|--|--|--|--|--|---|
| 207120
ASSIETTE DE PRÉSENTATION
PRESENTATION COUPE PLATE
PLATO PRESENTACIÓN
32 CM - 12 IN ^{5/8} | 207112
ASSIETTE PLATE
DINNER COUPE PLATE
PLATO REDONDO
29 CM - 11 IN ^{7/16} | 207113
ASSIETTE PLATE
DINNER COUPE PLATE
PLATO REDONDO
26 CM - 10 IN ^{1/4} | *239142 NEW
ASSIETTE PLATE
DINNER COUPE PLATE
PLATO REDONDO
24 CM - 9 IN ^{7/16} | 207111
ASSIETTE DESSERT
DESSERT/SALAD/
APP.COUPE PLATE
PLATO REDONDO
20 CM - 7 IN ^{7/8} | 207119
ASSIETTE À PAIN
BREAD & BUTTER
COUPE PLATE
PLATO DE PAN
15 CM - 5 IN ^{7/8} | 188537
BOL À SOUPE
MED BOWL, SOUP
BOL HONDO
13 CM - 5 IN ^{1/8}
H : 6 CM - 2 IN ^{3/8} | 207114
ASSIETTE CREUSE/
CALOTTE
ROUND SHALLOW BOWL
PLATO HONDO
20 CM - 7 IN ^{7/8} |
|---|---|--|--|--|--|--|---|



- | | | | | | | |
|---|--|---|--|--|--|--|
| 142722
BOL
DEEP BOWL, LARGE
BOL HONDO
28 CM - 11 IN
CONTENANCE : 2,5 L
CAPACITY : 84 OZ ^{3/16}
H : 12 CM - 4 IN ^{3/4} | 136529
BOL
DEEP BOWL, MEDIUM
BOL HONDO
24 CM - 9 IN ^{7/16}
CONTENANCE : 2 L
CAPACITY : 67 OZ ^{5/8}
H : 11 CM - 4 IN ^{1/4} | 136511
BOL
DEEP BOWL, MEDIUM
BOL HONDO
20 CM - 7 IN ^{7/8}
CONTENANCE : 1,30 L
CAPACITY : 43 OZ ^{15/16}
H : 9,5 CM - 3 IN ^{3/4} | 136528
BOL
DEEP BOWL, INDIVIDUAL
BOL HONDO
16 CM - 6 IN ^{5/16}
CONTENANCE : 67 CL
CAPACITY : 22 OZ ^{5/8}
H : 7,5 CM - 2 IN ^{5/16} | 154245
BOL
DEEP BOWL, SOUP
BOL HONDO
14 CM - 5 IN ^{1/2}
CONTENANCE : 55 CL
CAPACITY : 18 OZ ^{5/8}
H : 8 CM - 2 IN ^{11/16} | 136510
BOL
DEEP BOWL, RICE
BOL HONDO
12 CM - 4 IN ^{3/4}
CONTENANCE : 27 CL
CAPACITY : 9 OZ ^{1/8}
H : 5,5 CM - 2 IN ^{3/16} | 136509
BOL
DEEP BOWL, RAMEKIN
BOL HONDO
8 CM - 3 IN ^{1/8}
CONTENANCE : 8 CL
CAPACITY : 3 OZ ^{1/8}
H : 4,5 CM - 1 IN ^{3/4} |
|---|--|---|--|--|--|--|



- | | | | | |
|---|--|---|--|---|
| 136535
COUPE
PASTA/SALAD/SEAFOOD
BOWL, FOOTED
BOL
24 CM - 9 IN ^{7/16}
H : 11 CM - 4 IN ^{1/4} | 136532
COUPE
SHALLOW BOWL,
FOOTED
BOL
16 CM - 6 IN ^{5/16}
H : 7,5 CM - 2 IN ^{15/16} | 136530
COUPE
SHALLOW BOWL,
FOOTED
BOL
8 CM - 3 IN ^{1/8}
H : 2,5 CM - 1 IN | 233841
BOL CONIQUE
CONIC BOWL
BOL CÓNICO
30 CL - 10 OZ ^{1/8} | 233842
BOL CONIQUE
CONIC BOWL
BOL CÓNICO
1,15 L - 38 OZ ^{7/8} |
|---|--|---|--|---|

GRIS PERLE - LIGHT GREY - GRIS PERLA



- | | | | | |
|--|---|--|--|---|
| 230142
BOL
DEEP BOWL, MEDIUM
BOL HONDO
24 CM - 9 IN ^{7/16}
CONTENANCE : 2 L
CAPACITY : 67 OZ ^{5/8}
H : 11 CM - 4 IN ^{1/4} | 230141
BOL
DEEP BOWL, MEDIUM
BOL HONDO
20 CM - 7 IN ^{7/8}
CONTENANCE : 1,30 L
CAPACITY : 43 OZ ^{15/16}
H : 9,5 CM - 3 IN ^{3/4} | 230140
BOL
DEEP BOWL, INDIVIDUAL
BOL HONDO
16 CM - 6 IN ^{5/16}
CONTENANCE : 67 CL
CAPACITY : 22 OZ ^{5/8}
H : 7,5 CM - 2 IN ^{5/16} | 230139
BOL À DÉJEUNER
SOUP/BREAKFAST BOWL
BOL DESAYUNO
14 CM - 5 IN ^{1/2}
CONTENANCE : 55 CL
CAPACITY : 18 OZ ^{5/8}
H : 8 CM - 2 IN ^{11/16} | 230138
BOL À THÉ
TEA BOWL, RAMEKIN
BOL HONDO
9 CM - 3 IN ^{9/16}
CONTENANCE : 20 CL
CAPACITY : 6 OZ ^{3/4}
H : 4,5 CM - 1 IN ^{3/4} |
|--|---|--|--|---|

*Disponible à partir de mai 2020
Available in May 2020
Disponible en mayo 2020



Alldaydining

MODULO

Porcelaine
Porcelain - Porcelana



CARRÉE - SQUARE PLATE - PLATO CUADRADO



**207118
ASSIETTE DE PRÉSENTATION**
PRESENTATION COUPE PLATE
PLATO PRESENTACIÓN
28 CM - 11 IN



**207115
ASSIETTE PLATE**
DINNER COUPE PLATE
PLATO
24 CM - 9 IN^{7/8}



**207117
ASSIETTE DESSERT**
DESSERT/SALAD/APP.COUPE PLATE
PLATO
20 CM - 7 IN^{7/8}



**207123
ASSIETTE À PAIN**
BREAD & BUTTER COUPE PLATE
PLATO DE PAN
14 CM - 5 IN^{1/2}



**207116
ASSIETTE CREUSE**
SOUP/SALAD, COUPE PLATE
PLATO HONDO CUADRADO
20 CM - 7 IN^{3/8}



**149831
PLAT CREUX**
SQUARE DEEP DISH, COUPE
PLATO HONDO
28 CM - 11 IN
H : 5,5 CM - 2 IN^{3/8}



**154244
PLAT CREUX**
SQUARE DEEP DISH, COUPE
PLATO HONDO
16 CM - 6 IN^{5/8}
H : 6 CM - 2 IN^{3/8}



**136502
COUPE**
SQUARE BOWL, FOOTED COUPE
BOL
12 CM - 4 IN^{3/4}
H : 3,5 CM - 1 IN^{3/8}



**136503
COUPE**
SQUARE BOWL, FOOTED COUPE
BOL
8 CM - 3 IN^{1/8}
H : 2,5 CM - 1 IN



**181483
BOL CARRÉ**
SQUARE BOWL, DEEP
BOL HONDO
12 CM - 4 IN^{3/4}
H : 3,5 CM - 1 IN^{3/8}

RECTANGULAIRE - RECTANGULAR PLATE - PLATO RECTANGULAR



**181485
ASSIETTE PLATE**
PRESENTATION COUPE PLATE
PLATO RECTANGULAR
34 X 26 CM
13 IN^{3/8} X 10 IN^{1/4}



**207122
ASSIETTE PLATE**
DINNER COUPE PLATE
PLATO RECTANGULAR
30 X 22 CM
11 IN^{13/16} X 8 IN^{11/16}



**207110
ASSIETTE DESSERT**
DESSERT/SALAD/APP COUPE PLATE
PLATO RECTANGULAR
26 X 18 CM
10 IN^{1/4} X 7 IN^{1/16}

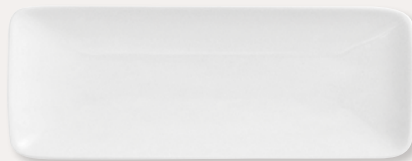

**207754
PLAT RECTANGULAIRE**
RECTANGULAR DISH, COUPE LARGE
PLATO RECTANGULAR
40 X 16 CM
15 IN^{3/4} X 6 IN^{5/16}



**207753
PLAT RECTANGULAIRE**
RECTANGULAR DISH, COUPE LARGE
PLATO RECTANGULAR
20 X 12 CM
7 IN^{7/8} X 4 IN^{3/4}

ACCESSOIRES - ACCESSORIES - ACCESORIOS



**209382
PRÉSENTOIR À GÂTEAUX**
ROUND APP/PIZZA/PRESENTATION STAND
EXPOSITOR DE TARTAS
32 CM - 12 IN^{5/8}
H : 10,5 CM - 4 IN^{1/4}



**209381
PRÉSENTOIR À GÂTEAUX**
ROUND APP/PIZZA/PRESENTATION STAND
EXPOSITOR DE TARTAS
25 CM - 9 IN^{13/16}
H : 8,5 CM - 2 IN^{3/8}



**136524
PLAT À TARTE**
PIE/PIZZA PLATE, FLAT
FUENTE PARA PASTEL
32 CM - 12 IN^{5/8}



**181490
VERRINE PORCELAIN**
RAMEKIN
VASITO PORCELANA
8 CL - 2 OZ^{11/16}



**182915
COFFRET SALIÈRE/POIVRIÈRE**
SALT & PEPPER CRUET
SALERO Y PIMENTERO

NEWCOOK MODULO



**162015
RAMEKIN**
RAMEKIN
9,5 CM - 3 IN^{3/4}



**162013
BOL À CONSOMÉ**
SOUP BOWL
BOL CONSOMÉ
10,5 CM - 4 IN^{1/8}
50 CL - 16 OZ^{15/16}



**162011
ASSIETTE À CRÈME BRÛLÉE**
«CRÈME BRÛLÉE» DISH
PLATO PARA GRATINAR
14 CM - 5 IN^{1/2}

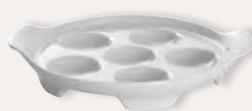

**164138
PLAT À ESCARGOTS 6 PLACES**
SNAIL TRAY 6 SPACES
BANDEJA CARACOLAS 6 COMPARTIMENTOS
16,6 X 11,2 CM - 6 IN^{9/16} X 4 IN^{7/16}



Alldaydining

MODULO

Porcelaine
Porcelain - Porcelana





207131
**ASSIETTE PLATE RECTANGLE
6 COMPARTIMENTS**
RECTANGULAR DINNER PLATE
6 COMPARTMENTS
PLATO RECTANGULAR/6 COMPARTIMENTOS
27X18 CM - 10 IN^{5/8} X 7 IN^{1/16}



207133
SOUCOUPE RECTANGULAIRE
RECTANGULAR PLATE/ SAUCER
PLATO RECTANGULAR
27X9 CM - 10 IN^{5/8} X 3 IN^{9/16}



Alldaydining

API

Porcelaine
Porcelain - Porcelana





234605
ASSIETTE DE PRÉSENTATION
PRESENTATION PLATE
PLATO PRESENTACIÓN
EXT : 32 CM - 12 IN^{5/8}
INT : 19 CM - 7 IN^{1/2}

234612
ASSIETTE DE PRÉSENTATION
PRESENTATION PLATE
PLATO PRESENTACIÓN
EXT : 30 CM - 11 IN^{13/16}
INT : 18 CM - 7 IN^{1/16}



234607
ASSIETTE PLATE
DINNER PLATE
PLATO REDONDO
EXT : 26,5 CM - 10 IN^{7/16}
INT : 17 CM - 6 IN^{11/16}

234608
ASSIETTE DESSERT
DESSERT PLATE
PLATO REDONDO
EXT : 21,5 CM - 8 IN^{7/16}
INT : 13 CM - 5 IN^{1/8}

234611
ASSIETTE DESSERT
DESSERT PLATE
PLATO REDONDO
EXT : 18,5 CM - 7 IN^{5/16}
INT : 11 CM - 4 IN^{5/16}



234609
ASSIETTE CREUSE CALOTTE
CEREAL PLATE
PLATO HONDO
EXT : 19 CM - 7 IN^{1/2}
INT : 12 CM - 4 IN^{3/4}



234610
ASSIETTE CREUSE BORD À AILE
ROUND DEEP PLATE
PLATO HONDO
EXT : 22,5 CM - 8 IN^{7/8}
INT : 13 CM - 5 IN^{1/8}



234603
ASSIETTE À PAIN
BREAD PLATE
PLATO DE PAN
EXT : 16 CM - 6 IN^{5/16}
INT : 10 CM - 3 IN^{15/16}



234604
BOL À SALADE AVEC AILE
SALAD BOWL WITH RIM
BOL DE ENSALADA CON ALETA
17,5 CM - 6 IN^{7/8}



234606
PLAT OVALE
OVAL DISH
FUENTE OVALADO
36,5 X 26,5 CM - 14 IN^{3/8} X 10 IN^{7/16}



Alldaydining

ECLIPSE

Porcelaine
Porcelain - Porcelana

MADE IN FRANCE



PORCELAINE BLANCHE - WHITE PORCELAIN - PORCELANA BLANCO



216529
ASSIETTE ULTRA PLATE RONDE
ROUND ULTRA PLATE
PLATO SÚPER PLANO
25 CM - 9 IN^{13/16}



216531
ASSIETTE ULTRA PLATE RONDE
ROUND ULTRA PLATE
PLATO SÚPER PLANO
12 CM - 4 IN^{3/4}



216536
ASSIETTE À CRÈME BRÛLÉE
«CRÈME BRÛLÉE» ROUND PLATE
PLATO PARA GRATINAR
13,5 CM - 5 IN^{5/16}

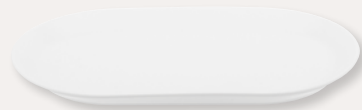

216532
ASSIETTE OBLONGUE
OBLONG PLATE
PLATO OBLANGA
32 X 19 CM - 12 IN^{5/8} X 7 IN^{1/2}



216530
ASSIETTE À SALADE RONDE AVEC PIED
FOOTED ROUND DEEP PLATE
PLATO DE ENSALADA CON PIE
20 CM - 7 IN^{7/8}



216535
COUPELLE RONDE AVEC PIED
FOOTED ROUND DEEP PLATE
BOL PEQUEÑO CON PIE
14 CM - 5 IN^{1/2}



216534
COUPELLE RONDE AVEC PIED
FOOTED ROUND DEEP PLATE
BOL PEQUEÑO CON PIE
12 CM - 4 IN^{3/4}



216533
ASSIETTE OBLONGUE
OBLONG PLATE
PLATO OBLANGA
20 X 12 CM - 7 IN^{7/8} X 4 IN^{3/4}

GRÈS GRIS - GRES STONEWARE - ARENISCA



198935
PLAT À GRATIN ROND
ROUND CASSEROLE PLATE
PLATO PARA GRATINAR
14 CM - 5 IN^{1/2}



198939
BOL À CONSOMÉ
SOUP BOWL
BOL CONSOMÉ
13 CM - 5 IN^{1/8}



198936
GOBELET ROND
ROUND TUMBLER
VASO REDONDO
9 CM - 3 IN^{9/16}

EMPILABLE
STACKABLE
APILABLE



Alldaydining

ESSENTIELLE

Porcelaine - Grès
Porcelain/Stoneware - Porcelana/Arenisca



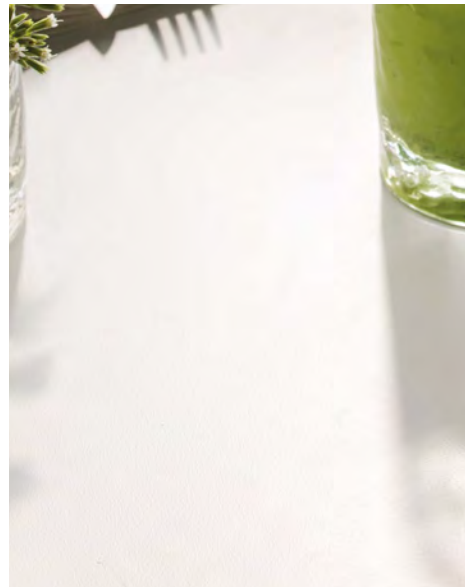

Finedining

COCOTTES

Porcelaine - Grès
Porcelain/Stoneware - Porcelana/Arenisca



EMPILABLE - STACKABLE - APILABLE

BLANC
WHITE
BLANCO



234342



235064



234341

BLANC SABLÉ
SANDY WHITE
ACABADO COLOR ARENA



234345



235065



234344

CARBONE
CARBONE/BLACK
NEGRO



234336



235066



234335

BLEU
BLUE
AZUL



234339



235063



234338

ONYX NEW
ONYX
ONYX

DUNE
BEIGE DUNE
BEIS DUNA

BASALTE
BROWN BASALT
BASALTO

ARGILE VERTE
GREEN CLAY
ARCILLA VERDE

BLEU DE ROCHE
BLUE STONE
AZUL DE ROCA

ROSE SABLE
PINK SAND
ROSA ARENA

(1)ASSIETTE COCOTTE
CASSEROLE PLATE
PLATO COCOTTE
22 CM - 8 IN^{11/16}
100 CL - 33 OZ^{13/16}

(2)ASSIETTE COCOTTE
CASSEROLE PLATE
PLATO COCOTTE
18 CM - 7 IN^{7/16}
70 CL - 23 OZ^{11/16}

BOL COCOTTE
ROUND CASSEROLE
BOL COCOTTE
17,5 CM - 6 IN^{7/8}
140 CL - 47 OZ^{5/16}

COCOTTES

Porcelaine - Grès
Porcelain/Stoneware - Porcelana/Arenisca



209383



209384



234340



186849



211891



209720



209384



234343



211893



211892



204041



204042



234334



234209



234208



230821



230820



234337



230822



230823



236555



236556



236554



236553



230927



230928



230926



230925



230944



230945



230943



230942



230958



230959



230957



230956



230972



230973



230971



230970



230910



230911



230909



230908

(3) BOL COCOTTE
ROUND CASSEOLE
BOL COCOTTE
14 CM - 5 IN^{1/2}
50 CL - 16 OZ^{15/16}

ASSIETTE/COUVERCLE
ROUND PLATE/CASSEROLE LID
BOL /PLATO PAN RONDO
12,5 CM - 4 IN^{5/16}

BOL BISEAUTÉ COCOTTE
SLANTED RIM BOWL
BOL BISEADO COCOTTE
16 CM - 6 IN^{5/16}
100 CL - 33 OZ^{13/16}

(4) BOL BISEAUTÉ COCOTTE
SLANTED RIM BOWL
BOL BISEADO COCOTTE
12 CM - 4 IN^{3/4}
30 CL - 10 OZ^{3/8}

BOL BISEAUTÉ COCOTTE
SLANTED RIM BOWL
BOL BISEADO COCOTTE
7,3 CM - 2 IN^{7/8}
7 CL - 2 OZ^{3/8}



ONYX - ONYX - ONYX NEW



236549
ASSIETTE PLATE
ROUND DINNER PLATE
PLATO REDONDO
EXT : 29 CM - 11 IN^{7/16}
INT : 25,5 CM - 10 IN^{1/16}

236548
ASSIETTE PLATE
ROUND DINNER PLATE
PLATO REDONDO
EXT : 26 CM - 10 IN^{1/4}
INT : 22 CM - 8 IN^{11/16}

236547
ASSIETTE PLATE
ROUND DINNER PLATE
PLATO REDONDO
EXT : 23 CM - 9 IN^{1/16}
INT : 19,5 CM - 7 IN^{11/16}

236546
ASSIETTE À PAIN
ROUND BREAD & BUTTER PLATE
PLATO DE PAN
EXT : 14 CM - 5 IN^{1/2}
INT : 10 CM - 3 IN^{15/16}

236550
ASSIETTE CREUSE
ROUND DEEP PLATE
PLATO HONDO
EXT : 20 CM - 7 IN^{7/8}
INT : 16,5 CM - 6 IN^{1/2}



236556
ASSIETTE /COUVERCLE
ROUND PLATE/CASSEROLE LID
BOL/PLATO RONDO PAN
12,5 CM - 4 IN^{5/16}

236555
BOL COCOTTE
ROUND CASSEROLE
BOL COCOTTE
14 CM - 5 IN^{1/2} - 50 CL - 16 OZ^{15/16}



236554
BOL BISEAUTÉ COCOTTE
SLANTED RIM BOWL
BOL BISEAUTÉ COCOTTE
12 CM - 4 IN^{3/4} - 30 CL - 10 OZ^{1/8}

236551
ASSIETTE GOURMET PETIT BASSIN
SHALLOW BOWL W/WIDE ROUND RIM
PLATO GOURMET REDONDO FONDO PEQUEÑO
EXT : 23 CM - 9 IN^{1/16}
INT : 11,5 CM - 4 IN^{1/2}

ROSE SABLE - PINK SAND - ROSA ARENA



230904
ASSIETTE PLATE
ROUND DINNER PLATE
PLATO REDONDO
EXT : 29 CM - 11 IN^{7/16}
INT : 25,5 CM - 10 IN^{1/16}

230903
ASSIETTE PLATE
ROUND DINNER PLATE
PLATO REDONDO
EXT : 26 CM - 10 IN^{1/4}
INT : 22 CM - 8 IN^{11/16}

230902
ASSIETTE PLATE
ROUND DINNER PLATE
PLATO REDONDO
EXT : 23 CM - 9 IN^{1/16}
INT : 19,5 CM - 7 IN^{11/16}

230901
ASSIETTE À PAIN
ROUND BREAD & BUTTER PLATE
PLATO DE PAN
EXT : 14 CM - 5 IN^{1/2}
INT : 10 CM - 3 IN^{15/16}

230905
ASSIETTE CREUSE
ROUND DEEP PLATE
PLATO HONDO
EXT : 20 CM - 7 IN^{7/8}
INT : 16,5 CM - 6 IN^{1/2}



230911
ASSIETTE/COUVERCLE
ROUND PLATE/CASSEROLE LID
BOL/PLATO RONDO PAN
12,5 CM - 4 IN^{5/16}

230910
BOL COCOTTE
ROUND CASSEROLE
BOL COCOTTE
14 CM - 5 IN^{1/2} - 50 CL - 16 OZ^{15/16}



230909
BOL BISEAUTÉ COCOTTE
SLANTED RIM BOWL
BOL BISEAUTÉ COCOTTE
12 CM - 4 IN^{3/4} - 30 CL - 10 OZ^{1/8}

230906
ASSIETTE GOURMET PETIT BASSIN
SHALLOW BOWL W/WIDE ROUND RIM
PLATO GOURMET REDONDO FONDO PEQUEÑO
EXT : 23 CM - 9 IN^{1/16}
INT : 11,5 CM - 4 IN^{1/2}

ARGILE VERTE - GREEN CLAY - ARCILLA VERDE



230952
ASSIETTE PLATE
ROUND DINNER PLATE
PLATO REDONDO
EXT : 29 CM - 11 IN^{7/16}
INT : 25,5 CM - 10 IN^{1/16}

230951
ASSIETTE PLATE
ROUND DINNER PLATE
PLATO REDONDO
EXT : 26 CM - 10 IN^{1/4}
INT : 22 CM - 8 IN^{11/16}

230950
ASSIETTE PLATE
ROUND DINNER PLATE
PLATO REDONDO
EXT : 23 CM - 9 IN^{1/16}
INT : 19,5 CM - 7 IN^{11/16}

230949
ASSIETTE À PAIN
ROUND BREAD & BUTTER PLATE
PLATO DE PAN
EXT : 14 CM - 5 IN^{1/2}
INT : 10 CM - 3 IN^{15/16}

230953
ASSIETTE CREUSE
ROUND DEEP PLATE
PLATO HONDO
EXT : 20 CM - 7 IN^{7/8}
INT : 16,5 CM - 6 IN^{1/2}



230959
ASSIETTE /COUVERCLE
ROUND PLATE/CASSEROLE LID
BOL/PLATO RONDO PAN
12,5 CM - 4 IN^{5/16}

230958
BOL COCOTTE
ROUND CASSEROLE
BOL COCOTTE
14 CM - 5 IN^{1/2} - 50 CL - 16 OZ^{15/16}



230957
BOL BISEAUTÉ COCOTTE
SLANTED RIM BOWL
BOL BISEAUTÉ COCOTTE
12 CM - 4 IN^{3/4} - 30 CL - 10 OZ^{1/8}

230954
ASSIETTE GOURMET PETIT BASSIN
SHALLOW BOWL W/WIDE ROUND RIM
PLATO GOURMET REDONDO FONDO PEQUEÑO
EXT : 23 CM - 9 IN^{1/16}
INT : 11,5 CM - 4 IN^{1/2}



©Patrick ROUGEREAU

Alldaydining

BAHIA

Grès
Stoneware - Arenisca



BASALTE - BROWN BASALT - BASALTO



230938
ASSIETTE PLATE
ROUND DINNER PLATE
PLATO REDONDO
EXT : 29 CM - 11 IN^{7/16}
INT : 25,5 CM - 10 IN^{1/16}

230937
ASSIETTE PLATE
ROUND DINNER PLATE
PLATO REDONDO
EXT : 26 CM - 10 IN^{1/4}
INT : 22 CM - 8 IN^{11/16}

230936
ASSIETTE PLATE
ROUND DINNER PLATE
PLATO REDONDO
EXT : 23 CM - 9 IN^{1/16}
INT : 19,5 CM - 7 IN^{11/16}



230935
ASSIETTE À PAIN
ROUND BREAD & BUTTER PLATE
PLATO DE PAN
EXT : 14 CM - 5 IN^{1/2}
INT : 10 CM - 3 IN^{15/16}



230939
ASSIETTE CREUSE
ROUND DEEP PLATE
PLATO HONDO
EXT : 20 CM - 7 IN^{7/8}
INT : 16,5 CM - 6 IN^{1/2}



230945
ASSIETTE / COUVERCLE
ROUND PLATE/CASSEROLE LID
BOL/PLATO RONDO PAN
12,5 CM - 4 IN^{5/16}

230944
BOL COCOTTE
ROUND CASSEROLE
BOL COCOTTE
14 CM - 5 IN^{1/2} - 50 CL - 16 OZ^{15/16}



230943
BOL BISEAUTÉ COCOTTE
SLANTED RIM BOWL
BOL BISEADO COCOTTE
12 CM - 4 IN^{3/4} - 30 CL - 10 OZ^{1/8}

230941
ASSIETTE GOURMET GRAND BASSIN
SHALLOW BOWL W/WIDE ROUND RIM
PLATO GOURMET HONDO FONDO GRANDE
EXT : 26 CM - 10 IN^{1/4}
INT : 14 CM - 5 IN^{1/2}

230940
ASSIETTE GOURMET PETIT BASSIN
SHALLOW BOWL W/WIDE ROUND RIM
PLATO GOURMET REDONDO FONDO PEQUEÑO
EXT : 23 CM - 9 IN^{1/16}
INT : 11,5 CM - 4 IN^{1/2}

BLEU DE ROCHE - BLUE STONE - AZUL DE ROCA

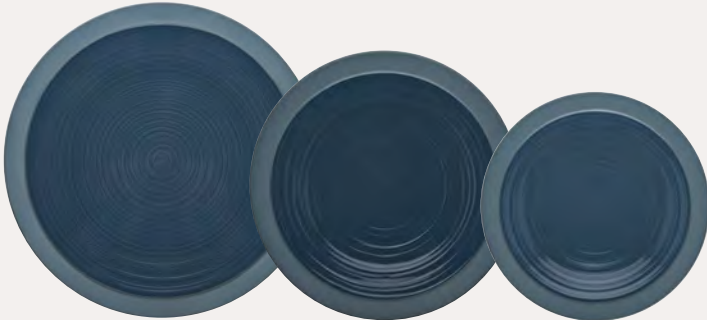

230966
ASSIETTE PLATE
ROUND DINNER PLATE
PLATO REDONDO
EXT : 29 CM - 11 IN^{7/16}
INT : 25,5 CM - 10 IN^{1/16}

230965
ASSIETTE PLATE
ROUND DINNER PLATE
PLATO REDONDO
EXT : 26 CM - 10 IN^{1/4}
INT : 22 CM - 8 IN^{11/16}

230964
ASSIETTE PLATE
ROUND DINNER PLATE
PLATO REDONDO
EXT : 23 CM - 9 IN^{1/16}
INT : 19,5 CM - 7 IN^{11/16}



230963
ASSIETTE À PAIN
ROUND BREAD & BUTTER PLATE
PLATO DE PAN
EXT : 14 CM - 5 IN^{1/2}
INT : 10 CM - 3 IN^{15/16}



230967
ASSIETTE CREUSE
ROUND DEEP PLATE
PLATO HONDO
EXT : 20 CM - 7 IN^{7/8}
INT : 16,5 CM - 6 IN^{1/2}



230973
ASSIETTE / COUVERCLE
ROUND PLATE/CASSEROLE LID
BOL/PLATO RONDO PAN
12,5 CM - 4 IN^{5/16}

230972
BOL COCOTTE
ROUND CASSEROLE
BOL COCOTTE
14 CM - 5 IN^{1/2} - 50 CL - 16 OZ^{15/16}



230971
BOL BISEAUTÉ COCOTTE
SLANTED RIM BOWL
BOL BISEADO COCOTTE
12 CM - 4 IN^{3/4} - 30 CL - 10 OZ^{1/8}

230969
ASSIETTE GOURMET GRAND BASSIN
SHALLOW BOWL W/WIDE ROUND RIM
PLATO GOURMET HONDO FONDO GRANDE
EXT : 26 CM - 10 IN^{1/4}
INT : 14 CM - 5 IN^{1/2}

230968
ASSIETTE GOURMET PETIT BASSIN
SHALLOW BOWL W/WIDE ROUND RIM
PLATO GOURMET REDONDO FONDO PEQUEÑO
EXT : 23 CM - 9 IN^{1/16}
INT : 11,5 CM - 4 IN^{1/2}

DUNE - BEIGE DUNE - BEIS DUNA



230921
ASSIETTE PLATE
ROUND DINNER PLATE
PLATO REDONDO
EXT : 29 CM - 11 IN^{7/16}
INT : 25,5 CM - 10 IN^{1/16}

230920
ASSIETTE PLATE
ROUND DINNER PLATE
PLATO REDONDO
EXT : 26 CM - 10 IN^{1/4}
INT : 22 CM - 8 IN^{11/16}

230919
ASSIETTE PLATE
ROUND DINNER PLATE
PLATO REDONDO
EXT : 23 CM - 9 IN^{1/16}
INT : 19,5 CM - 7 IN^{11/16}



230918
ASSIETTE À PAIN
ROUND BREAD & BUTTER PLATE
PLATO DE PAN
EXT : 14 CM - 5 IN^{1/2}
INT : 10 CM - 3 IN^{15/16}



230922
ASSIETTE CREUSE
ROUND DEEP PLATE
PLATO HONDO
EXT : 20 CM - 7 IN^{7/8}
INT : 16,5 CM - 6 IN^{1/2}



230928
ASSIETTE / COUVERCLE
ROUND PLATE/CASSEROLE LID
BOL/PLATO RONDO PAN
12,5 CM - 4 IN^{5/16}

230927
BOL COCOTTE
ROUND CASSEROLE
BOL COCOTTE
14 CM - 5 IN^{1/2} - 50 CL - 16 OZ^{15/16}



230926
BOL BISEAUTÉ COCOTTE
SLANTED RIM BOWL
BOL BISEADO COCOTTE
12 CM - 4 IN^{3/4} - 30 CL - 10 OZ^{1/8}

230924
ASSIETTE GOURMET GRAND BASSIN
SHALLOW BOWL W/WIDE ROUND RIM
PLATO GOURMET HONDO FONDO GRANDE
EXT : 26 CM - 10 IN^{1/4}
INT : 14 CM - 5 IN^{1/2}

230923
ASSIETTE GOURMET PETIT BASSIN
SHALLOW BOWL W/WIDE ROUND RIM
PLATO GOURMET REDONDO FONDO PEQUEÑO
EXT : 23 CM - 9 IN^{1/16}
INT : 11,5 CM - 4 IN^{1/2}



Alldaydining

BAHIA

Grès
Stoneware - Arenisca



ACCESSOIRES - ACCESSORIES - ACCESORIOS

NEW

SALADIER

BOWL
BOL
28 CM - 11 IN



235223



235222

NEW

PLANCHE

BOARD
PLANCHA
25 X 13,5 CM
9 IN^{3/16} X 5 IN^{5/16}



237206



234949



234948



234950

**BOL BISEAUTÉ
COCOTTE**

SLANTED RIM BOWL
BOL BISEADO COCOTTE
7,3 CM - 2 IN^{7/8}
7 CL - 2 OZ^{3/8}



236553



230956



230925



230942



230970



230908

NEW

ONYX
ONYX
ONYX

ARGILE VERTE
GREEN CLAY
ARCILLA VERDE

DUNE
BEIGE DUNE
BEIS DUNA

BASALTE
BASALT BROWN
BASALTO

BLEU DE ROCHE
BLUE STONE
AZUL DE ROCA

ROSE SABLE
PINK SAND
ROSA ARENA

CAFÉTERIE - TEATIME - TÉ CAFÉ

TASSE À ESPRESSO

ESPRESSO CUP
TAZA DE ESPRESSO
11 CL - 3 OZ^{3/4}



236557



230960



230929



230946



230974



230912

TASSE À THÉ

COFFEE/TEA CUP
TAZA DE TÉ
20 CL - 6 OZ^{3/4}



236559



230962



230931



230948



230976



230914

MUG À THÉ

TEA MUG
MUG
38 CL - 12 OZ^{7/8}



230961



230930



230947



230975



230913

NEW

ONYX
ONYX
ONYX

ARGILE VERTE
GREEN CLAY
ARCILLA VERDE

DUNE
BEIGE DUNE
BEIS DUNA

BASALTE
BASALT BROWN
BASALTO

BLEU DE ROCHE
BLUE STONE
AZUL DE ROCA

ROSE SABLE
PINK SAND
ROSA ARENA



©Patrick ROUGÈREAU

Alldaydining

BAHIA

Grès
Stoneware - Arenisca



PIERRE DE LAVE - LAVA STONE - PIEDRA DE LAVA



194455
ASSIETTE DE PRÉSENTATION
PRESENTATION PLATE, COUPE
PLATO PRESENTACIÓN
31,5 CM - 12 IN^{3/8}

194454
ASSIETTE PLATE
DINNER PLATE, COUPE
PLATO REDONDO
28 CM - 11 IN

194453
ASSIETTE DESSERT
DESSERT/SALAD PLATE, COUPE
PLATO REDONDO
21 CM - 8 IN^{1/4}



230092
ASSIETTE À PAIN
BREAD & BUTTER PLATE, COUPE
PLATO DE PAN
16 CM - 6 IN^{5/16}



234455
COUPE RONDE
ROUND CUP
BOL
25 CM - 9 IN^{13/16}



194452
ASSIETTE CALOTTE
SALAD/CEREAL PLATE
PLATO HONDO
21 CM - 8 IN^{1/4}



194462
SALADIER
SALAD BOWL, DEEP
ENSALADERA
24 CM - 9 IN^{7/16}
H : 8 CM - 3 IN^{3/16}



194457
COUPE/CALOTTE
SALAD/CEREAL PLATE, DEEP
BOL
17,7 CM - 6 IN^{15/16}
H : 5,5 CM - 2 IN^{3/16}



194456
BOL À DEJEUNER
SOUP/BREAKFAST BOWL
BOL DESAYUNO
14 CM - 5 1/2 CL
5 IN^{1/2} - 19 OZ^{5/8}



194458
COUPELLE
SMALL BOWL, CUP
BOL PEQUEÑO
10 CM - 3 IN^{15/16}
H : 6 CM - 2 IN^{3/8}



194459
TASSE À CAFÉ
DEMITASSE CUP
TAZA DE CAFÉ
11,5 CL - 3 OZ^{7/8}

194460
SOUCOUPE À CAFÉ
DEMITASSE SAUCER
ESPRESSO CAFÉ
12,5 CM - 4 IN^{15/16}



230093
TASSE À THÉ
TEA CUP
TAZA DE TÉ
25 CL - 8 OZ^{7/16}

230094
SOUCOUPE À THÉ
DEMITASSE/TEA SAUCER
PLATO TÉ
15 CM - 5 OZ^{7/8}



194461
MUG À THÉ
MUG
TÈ MUG
33 CL - 11 OZ^{3/16}

KAOLIN - CAOLÍN



184088
ASSIETTE DE PRÉSENTATION
PRESENTATION PLATE, COUPE
PLATO PRESENTACIÓN
31,5 CM - 12 IN^{3/8}

184077
ASSIETTE PLATE
DINNER PLATE, COUPE
PLATO REDONDO
28 CM - 11 IN

184078
ASSIETTE DESSERT
DESSERT/SALAD PLATE, COUPE
PLATO ILANO
21 CM - 8 IN^{1/4}



209092
ASSIETTE À PAIN
BREAD & BUTTER PLATE, COUPE
PLATO DE PAN
16 CM - 6 IN^{5/16}



234449
COUPE RONDE
ROUND CUP
BOL
25 CM - 9 IN^{13/16}



184079
ASSIETTE CALOTTE
SALAD/CEREAL PLATE
PLATO HONDO
21 CM - 8 IN^{1/4}



184087
SALADIER
SALAD BOWL, DEEP
ENSALADERA
24 CM - 9 IN^{7/16}
H : 8 CM - 3 IN^{3/16}



184086
COUPE/CALOTTE
SALAD/CEREAL PLATE, DEEP
BOL
17,7 CM - 6 IN^{15/16}
H : 5,5 CM - 2 IN^{3/16}



184084
BOL À DEJEUNER
SOUP/BREAKFAST BOWL
BOL DESAYUNO
14 CM - 5 1/2 CL
5 IN^{1/2} - 19 OZ^{5/8}



184085
COUPELLE
SMALL BOWL, CUP
BOL PEQUEÑO
10 CM - 3 IN^{15/16}
H : 6 CM - 2 IN^{3/8}



184081
TASSE À CAFÉ
DEMITASSE CUP
TAZA DE CAFÉ
11,5 CL - 3 OZ^{7/8}

184082
SOUCOUPE À CAFÉ
DEMITASSE SAUCER
ESPRESSO CAFÉ
12,5 CM - 4 IN^{15/16}



230163
TASSE À THÉ
TEA CUP
TAZA DE TÉ
25 CL - 8 OZ^{7/16}

230164
SOUCOUPE À THÉ
DEMITASSE/TEA SAUCER
PLATO TÉ
15 CM - 5 OZ^{7/8}



184083
MUG À THÉ
MUG
TÈ MUG
33 CL - 11 OZ^{3/16}



Alldaydining

MODULO NATURE

Grès
Stoneware - Arenisca



BLEU GALET - BLUE - AZUL



225342
ASSIETTE DE PRÉSENTATION
PRESENTATION PLATE, COUPE
PLATO PRESENTACIÓN
31,5 CM - 12 IN^{3/8}

225343
ASSIETTE PLATE
DINNER PLATE, COUPE
PLATO REDONDO
28 CM - 11 IN

225344
ASSIETTE DESSERT
DESSERT/SALAD PLATE, COUPE
PLATO ILANO
21 CM - 8 IN^{1/4}

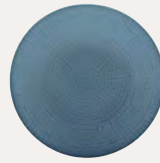

225353
ASSIETTE À PAIN
BREAD & BUTTER PLATE, COUPE
PLATO DE PAN
16 CM - 6 IN^{5/16}



225345
ASSIETTE CALOTTE
SALAD/CEREAL PLATE
PLATO HONDO
21 CM - 8 IN^{1/4}



225347
COUPE/CALOTTE
SALAD/CEREAL PLATE, DEEP
BOL
17,7 CM - 6 IN^{15/16}
H : 5,5 CM - 2 IN^{3/16}



225349
SALADIER
SALAD BOWL, DEEP
ENSALADERA
24 CM - 9 IN^{7/16}
H : 8 CM - 3 IN^{3/16}



225346
COUPELLE
SMALL BOWL, CUP
BOL PEQUEÑO
10 CM - 3 IN^{15/16}
H : 6 CM - 2 IN^{3/8}



225351
TASSE À CAFÉ
DEMITASSE CUP
TAZA DE CAFÉ
11,5 CL - 3 OZ^{7/8}

225352
SOUCOUE À CAFÉ
DEMITASSE SAUCER
ESPRESSO CAFÉ
12,5 CM - 4 IN^{15/16}



230167
TASSE À THÉ
TEA CUP
TAZA DE TÉ
25 CL - 8 OZ^{7/16}

230168
SOUCOUE À THÉ
DEMITASSE/TEA SAUCER
PLATO TÉ
15 CM - 5 OZ^{7/8}

TERRE D'OMBRE - TAUPE - TIERRA DE SOMBRA



184101
ASSIETTE DE PRÉSENTATION
PRESENTATION PLATE, COUPE
PLATO PRESENTACIÓN
31,5 CM - 12 IN^{3/8}

184090
ASSIETTE PLATE
DINNER PLATE, COUPE
PLATO REDONDO
28 CM - 11 IN

184091
ASSIETTE DESSERT
DESSERT/SALAD PLATE, COUPE
PLATO ILANO
21 CM - 8 IN^{1/4}



209093
ASSIETTE À PAIN
BREAD & BUTTER PLATE, COUPE
PLATO DE PAN
16 CM - 6 IN^{5/16}



184092
ASSIETTE CALOTTE
SALAD/CEREAL PLATE
PLATO HONDO
21 CM - 8 IN^{1/4}



234451
COUPE RONDE
ROUND CUP
BOL
25 CM - 9 IN^{13/16}



184100
SALADIER
SALAD BOWL, DEEP
ENSALADERA
24 CM - 9 IN^{7/16}
H : 8 CM - 3 IN^{3/16}



184099
COUPE/CALOTTE
SALAD/CEREAL PLATE, DEEP
BOL
17,7 CM - 6 IN^{15/16}
H : 5,5 CM - 2 IN^{3/16}



184097
BOL À DEJEUNER
SOUP/BREAKFAST BOWL
BOL DESAYUNO
14 CM - 5,8 CL
5 IN^{1/2} - 19 OZ^{5/8}



184098
COUPELLE
SMALL BOWL, CUP
BOL PEQUEÑO
10 CM - 3 IN^{15/16}
H : 6 CM - 2 IN^{3/8}



184094
TASSE À CAFÉ
DEMITASSE CUP
TAZA DE CAFÉ
11,5 CL - 3 OZ^{7/8}

184095
SOUCOUE À CAFÉ
DEMITASSE SAUCER
ESPRESSO CAFÉ
12,5 CM - 4 IN^{15/16}



230165
TASSE À THÉ
TEA CUP
TAZA DE TÉ
25 CL - 8 OZ^{7/16}

230166
SOUCOUE À THÉ
DEMITASSE/TEA SAUCER
PLATO TÉ
15 CM - 5 OZ^{7/8}



184096
MUG À THÉ
MUG
TÉ MUG
33 CL - 11 OZ^{3/16}



Alldaydining

MODULO NATURE

Grès
Stoneware - Arenisca



VERT SHISHO - SHISHO GREEN - VERDE SHISHO



ROUGE PIMENT - RED CHILI - ROJO PIMIENTO



CRISTAUX DE SEL - SALT WHITE - CRISTALES DE SAL



BLEU INDIGO - INDIGO BLUE - AZUL AÑIL



ASSIETTE À PARTAGER RONDE
ROUND SHARED PLATE
PLATO PARA COMPARTIR
20 CM - 7 IN^{7/8}

ASSIETTE PLATE RONDE
ROUND DINNER PLATE
PLATO REDONDO
26 CM - 10 IN^{1/4}

COUPELLE RONDE
ROUND SMALL BOWL
BOL PEQUEÑO
12,5 CM - 4 IN^{15/16}
33 CL - 11 OZ^{3/16}

GRANDES ASSIETTES CREUSES RONDEN
ROUND LARGE DEEP PLATES
GRANDE PLATO REDONDO
22,5 CM - 8 IN^{7/8}
1L - 33 OZ^{15/16}

BOL
BOWL
BOL
19 CM - 7 IN^{1/2}
1,1 L - 37 OZ^{1/16}



Alldaydining

MONDO

Grès

Stoneware - Arenisca



VINS FRANÇAIS
IGP PAYS D'OC AOP
PETIT CHABLIS AOP
MONTAGNI T^{er} CRU
CÔTEAUX DU LAVAL AOP
SANTÉRIE AOP
QUINCY AOP

VINS D'ALSACE
IGP VINS
CÔTES DE PROVENCE AOP
BANDOL AOP
CÔTE D'AZUR AOP

VINS DE FRANCE
SANTÉRIE AOP
CÔTES DU ROUSSILLON AOP
BORDEAUX AOP
BESSAC-LOGNON AOP
SHIM-ESTÉPHE AOP
BEAUNE AOP
MERCUREY AOP

VINS EN BOUTEILLE
ROUGE BORDEAUX
Blanc-IGP PAYS
Rouge IGP







CAFÉTERIE

Le thé et le café sont des univers où le plaisir des sens est décuplé par le plaisir esthétique. Pour rendre ces instants de dégustation uniques, DEGRENNÉ propose une large sélection de tasses et accessoires. Collection iconique de la marque depuis 1953, redécouvrez Salam et réunissez tous les éléments pour maîtriser l'Art du Thé.

TEATIME

Drinking tea and coffee is a sensory delight heightened by the sheer aesthetic pleasure of the experience. DEGRENNÉ offers a wide range of cups and accessories to make tea and coffee drinking a unique experience. An iconic DEGRENNÉ collection since 1953 - why not seize the opportunity to rediscover Salam and gather together the essentials needed to be skilled in the art of tea.

TÉ - CAFÉ

El Té y el Café son universos en los que el placer de los sentidos se potencia con el placer estético. Para hacer que esos momentos de degustación sean únicos, DEGRENNÉ propone una amplia selección de tazas y accesorios. Colección única de la marca desde 1953, redescubra Salam y reúna todos los elementos para dominar el arte del té.





REVISITER UNE ICÔNE

Créée en 1953, la théière Salam est le produit emblématique de la marque DEGRENNE. La finesse de la porcelaine alliée à l'éclat de la cloche sublime l'instant thé. Grâce à sa cloche tapissée d'une feutrine, **le thé conserve une température optimale deux fois plus longtemps que dans une théière classique**. Un procédé astucieux qui permet au thé de déployer toute la subtilité de ses saveurs au fil de la dégustation.

REVISIT AN ICON

Created in 1953, Salam teapot is the iconic product of DEGRENNE. The finesse of porcelain combined with the radiance of the outer body enhances the tea experience. With its inner lining of thin felt, **the tea inside is kept at its optimum temperature for twice as long as in a regular teapot**. This is a clever trick to ensure that the tea is infused with all the subtlety of its flavours as the tasting progresses.

VOLVER A EXPLORAR UN ICONO

Creada en 1953, la tetera Salam es el producto emblemático de la marca DEGRENNE. La finura de la porcelana combinada con el brillo del cuerpo de la tetera sublima el instante del té. Gracias a su cuerpo tapizado con fieltro, **el té conserva una temperatura óptima el doble de tiempo que una tetera clásica**. Este ingenioso proceso permite que el té despliegue toda la sutilidad de sus aromas a lo largo de la degustación.

SALAM BLANCHE - WHITE - BLANCO



211990

THÉIÈRE 8 TASSES

TEA POT 8 CUPS
TETERA 8 TAZAS
130 CL - 43 OZ^{13/16}



211989

THÉIÈRE 6 TASSES

TEA POT 6 CUPS
TETERA 6 TAZAS
100 CL - 33 OZ^{13/16}



211988

THÉIÈRE 4 TASSES

TEA POT 4 CUPS
TETERA 4 TAZAS
70 CL - 23 OZ^{11/16}



211987

THÉIÈRE 2 TASSES

TEA POT 2 CUPS
TETERA 2 TAZAS
35 CL - 11 OZ^{13/16}



205135

2/4 TASSES

2/4 CUPS
2/4 TAZAS



205136

6/8 TASSES

6/8 CUPS
6/8 TAZAS



189949

CORPS THÉIÈRE 8 TASSES

TEA POT 8 CUPS WITHOUT LID
CUERPO TETERA 8 TAZAS
130 CL - 43 OZ^{13/16}



189948

CORPS THÉIÈRE 6 TASSES

TEA POT 6 CUPS WITHOUT LID
CUERPO TETERA 6 TAZAS
100 CL - 33 OZ^{13/16}



189947

CORPS THÉIÈRE 4 TASSES

TEA POT 4 CUPS WITHOUT LID
CUERPO TETERA 4 TAZAS
100 CL - 33 OZ^{13/16}



189946

CORPS THÉIÈRE 2 TASSES

TEA POT 2 CUPS WITHOUT LID
CUERPO TETERA 2 TAZAS
35 CL - 11 OZ^{13/16}



210575

2/4 TASSES

2/4 CUPS
2/4 TAZAS



210576

6/8 TASSES

6/8 CUPS
6/8 TAZAS

SALAM NOIRE - BLACK - NEGRO



211994

THÉIÈRE 8 TASSES

TEA POT 8 CUPS
TETERA 8 TAZAS
130 CL - 43 OZ^{13/16}



211993

THÉIÈRE 6 TASSES

TEA POT 6 CUPS
TETERA 6 TAZAS
100 CL - 33 OZ^{13/16}



216414

THÉIÈRE 6 TASSES

TEA POT 6 CUPS
TETERA 6 TAZAS
100 CL - 33 OZ^{13/16}



211992

THÉIÈRE 4 TASSES

TEA POT 4 CUPS
TETERA 4 TAZAS
70 CL - 23 OZ^{11/16}



216410

4 THÉIÈRE TASSES

TEA POT 4 CUPS
TETERA 4 TAZAS
70 CL - 23 OZ^{11/16}



211991

THÉIÈRE 2 TASSES

TEA POT 2 CUPS
TETERA 2 TAZAS
35 CL - 11 OZ^{13/16}



150447

CORPS THÉIÈRE 8 TASSES

TEA POT 8 CUPS WITHOUT LID
CUERPO TETERA 8 TAZAS
130 CL - 43 OZ^{13/16}



150456

CORPS THÉIÈRE 6 TASSES

TEA POT 6 CUPS WITHOUT LID
CUERPO TETERA 6 TAZAS
100 CL - 33 OZ^{13/16}



150455

CORPS THÉIÈRE 4 TASSES

TEA POT 4 CUPS WITHOUT LID
CUERPO TETERA 4 TAZAS
100 CL - 33 OZ^{13/16}



150450

CORPS THÉIÈRE 2 TASSES

TEA POT 2 CUPS WITHOUT LID
CUERPO TETERA 2 TAZAS
35 CL - 11 OZ^{13/16}

SALAM COLOR

CLOCHE ALUMINIUM ZINC

ZINC ALUMINIUM LID - CAMPANA ZINC ALUMINIO



216416

THÉIÈRE 6 TASSES

TEA POT 6 CUPS
TETERA 6 TAZAS
100 CL - 33 OZ^{13/16}



216412

THÉIÈRE 4 TASSES

TEA POT 4 CUPS
TETERA 4 TAZAS
70 CL - 23 OZ^{11/16}



216415

THÉIÈRE 6 TASSES

TEA POT 6 CUPS
TETERA 6 TAZAS
100 CL - 33 OZ^{13/16}



216411

THÉIÈRE 4 TASSES

TEA POT 4 CUPS
TETERA 4 TAZAS
70 CL - 23 OZ^{11/16}



225359

THÉIÈRE 6 TASSES

TEA POT 6 CUPS
TETERA 6 TAZAS
100 CL - 33 OZ^{13/16}



225358

THÉIÈRE 4 TASSES

TEA POT 4 CUPS
TETERA 4 TAZAS
70 CL - 23 OZ^{11/16}

CLOCHE INOX DORÉ

GOLD STAINLESS STEEL LID - CAMPANA DORADO INOX



234217

THÉIÈRE 6 TASSES

TEA POT 6 CUPS
TETERA 6 TAZAS
100 CL - 33 OZ^{13/16}



234216

THÉIÈRE 4 TASSES

TEA POT 4 CUPS
TETERA 4 TAZAS
70 CL - 23 OZ^{11/16}

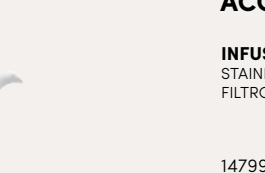

147992

2 TASSES

2 CUPS - 2 TAZAS

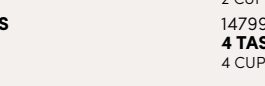

147994

4 TASSES

4 CUPS - 4 TAZAS

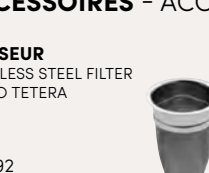

147993

6/8 TASSES

6/8 CUPS - 6/8 TAZAS



217130

2 TASSES

2 CUPS - 2 TAZAS



217132

6 TASSES

6 CUPS - 6 TAZAS



217131

4 TASSES

4 CUPS - 4 TAZAS

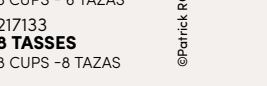

217133

8 TASSES

8 CUPS - 8 TAZAS

ACCESSOIRES - ACCESSORIES - ACCESORIOS

INFUSEUR

STAINLESS STEEL FILTER
FILTRO TETERA



FEUTRE NOIR ISOLANT POUR THÉIÈRE

BLACK TEA POT FELT
FIELTRO NEGRO AISLANTE TETERA

Alldaydining

SALAM

Porcelaine
Porcelain - Porcelana



BLANC - WHITE - BLANCO



210946
TASSE À CAFÉ
DEMITASSE CUP
TAZA DE CAFÉ
11 CL - 3 OZ^{3/4}



210947
TASSE À THÉ
COFFEE/TEA CUP
TAZA DE TÉ
25 CL - 8 OZ^{7/16}



210948
TASSE DÉJEUNER
BREAKFAST CUP
TAZA DESAYUNO
42 CL - 14 OZ^{3/16}



210949
MUG À THÉ
TEA MUG
MUG
38 CL - 12 OZ^{7/8}



210950
SOUCOPE CAFÉ/THÉ
DEMITASSE/COFFEE/TEA SAUCER
PLATO CAFÉ/TÉ
16 CM - 6 IN^{5/16}

GRIS PERLE - LIGHT GREY - GRIS PERLA



230145
TASSE À CAFÉ
DEMITASSE CUP
TAZA DE CAFÉ
11 CL - 3 OZ^{3/4}



230146
TASSE À THÉ
COFFEE/TEA CUP
TAZA DE TÉ
25 CL - 8 OZ^{7/16}



230147
TASSE DÉJEUNER
BREAKFAST CUP
TAZA DESAYUNO
42 CL - 14 OZ^{3/16}



230148
MUG À THÉ
TEA MUG
MUG
38 CL - 12 OZ^{7/8}



210951
SOUCOPE DÉJEUNER/MUG
BREAKFAST/MUG SAUCER
PLATO DESAYUNO/MUG
18 CM - 7 IN^{1/16}

ROSE POUDRÉ - POWDER PINK - POLVO ROSA



230130
TASSE À CAFÉ
DEMITASSE CUP
TAZA DE CAFÉ
11 CL - 3 OZ^{3/4}



230131
TASSE À THÉ
COFFEE/TEA CUP
TAZA DE TÉ
25 CL - 8 OZ^{7/16}



230132
TASSE DÉJEUNER
BREAKFAST CUP
TAZA DESAYUNO
42 CL - 14 OZ^{3/16}



230133
MUG À THÉ
TEA MUG
MUG
38 CL - 12 OZ^{7/8}

ACCESSOIRES - ACCESSORIES - ACCESORIOS



187276
SUCRIER
SUGAR BOWL
AZUCARERO CON TAPA
28 CL - 9 OZ^{7/16}



150475
SUCRIER
SUGAR BOWL
AZUCARERO CON TAPA
28 CL - 9 OZ^{7/16}



187283
CORPS SUCRIER
SUGAR BOWL WITHOUT LID
AZUCARERO



150469
CORPS SUCRIER
SUGAR BOWL WITHOUT LID
AZUCARERO



187277
CRÉMIER
CREAMER, JUG
LECHERA
15 CL - 5OZ^{1/16}



150485
CRÉMIER
CREAMER, JUG
LECHERA
15 CL - 5OZ^{1/16}

©Patrick ROUGEREAU
Bevres et alcool ne font pas vous, mais vous.
Beverages and alcohol don't make you, but you.
El abuso de alcohol es peligroso para la salud.



Alldaydining

SALAM THÉ

Porcelaine
Porcelain - Porcelana



COLLECTION L



227828
TASSE ESPRESSO
DEMITASSE CUP
ESPRESSO TAZA
10 CL - 3 OZ^{3/8}

227831
SOUCOUPE ESPRESSO
DEMITASSE SAUCER
ESPRESSO PLATO
12,5 CM - 4 IN^{15/16}



227829
TASSE LUNGO
COFFEE/TEA CUP
LUNGO TAZA
25 CL - 8 OZ^{7/16}

227832
SOUCOUPE LUNGO
COFFEE/TEA SAUCER
LUNGO PLATO
15,8 CM - 6 IN^{1/4}

COLLECTION L FRAGMENT



227828
TASSE ESPRESSO
DEMITASSE CUP
ESPRESSO TAZA
10 CL - 3 OZ^{3/8}

227849
SOUCOUPE ESPRESSO
DEMITASSE SAUCER
ESPRESSO PLATO
12,6 CM - 4 IN^{15/16}



227829
TASSE LUNGO
COFFEE/TEA CUP
LUNGO TAZA
25 CL - 8 OZ^{7/16}

227850
SOUCOUPE LUNGO
COFFEE/TEA SAUCER
LUNGO PLATO
15,8 CM - 6 IN^{1/4}

COLLECTION L COUTURE



227828
TASSE ESPRESSO
DEMITASSE CUP
ESPRESSO TAZA
10 CL - 3 OZ^{3/8}

237404
SOUCOUPE ESPRESSO
DEMITASSE SAUCER
ESPRESSO PLATO
12,6 CM - 4 IN^{15/16}



227829
TASSE LUNGO
COFFEE/TEA CUP
LUNGO TAZA
25 CL - 8 OZ^{7/16}

237405
SOUCOUPE LUNGO
COFFEE/TEA SAUCER
LUNGO PLATO
15,8 CM - 6 IN^{1/4}

COLLECTION L PERLES DE ROSÉE



227828
TASSE ESPRESSO
DEMITASSE CUP
ESPRESSO TAZA
10 CL - 3 OZ^{3/8}

233928
SOUCOUPE ESPRESSO
DEMITASSE SAUCER
ESPRESSO PLATO
12,6 CM - 4 IN^{15/16}



227829
TASSE LUNGO
COFFEE/TEA CUP
LUNGO TAZA
25 CL - 8 OZ^{7/16}

233929
SOUCOUPE LUNGO
COFFEE/TEA SAUCER
LUNGO PLATO
15,8 CM - 6 IN^{1/4}

NEWPORT Porcelaine – Porcelain – Porcelana



207756
TASSE ESPRESSO
DEMITASSE CUP
ESPRESSO TAZA
10 CL - 3 OZ^{3/8}

207759
SOUCOUPE ESPRESSO
DEMITASSE SAUCER
ESPRESSO PLATO
12,5 CM - 4 IN^{5/16}



207757
TASSE LUNGO
COFFEE/TEA CUP
LUNGO TAZA
20 CL - 6 OZ^{3/4}

207760
SOUCOUPE LUNGO
COFFEE/TEA SAUCER
LUNGO PLATO
15,8 CM - 5 IN^{7/16}



207758
TASSE DÉJEUNER
BREAKFAST CUP
TAZA DESAYUNO
40 CL - 13 OZ^{1/2}

207761
SOUCOUPE DÉJEUNER
BREAKFAST SAUCER
PLATO DESAYUNO
18 CM - 7 IN^{7/16}



207756
TASSE ESPRESSO
DEMITASSE CUP
ESPRESSO TAZA
10 CL - 3 OZ^{3/8}

223406
SOUCOUPE ESPRESSO
DEMITASSE SAUCER
ESPRESSO PLATO
12,5 CM - 4 IN^{15/16}



207757
TASSE LUNGO
COFFEE/TEA CUP
LUNGO TAZA
20 CL - 6 OZ^{3/4}

223407
SOUCOUPE LUNGO
COFFEE/TEA SAUCER
LUNGO PLATO
15 CM - 5 IN^{7/8}



207763
VERSEUSE
COFFEE/TEA POT
CAFETERA/TETERA
40 CL - 13 OZ^{1/2}



207764
VERSEUSE
COFFEE/TEA POT
CAFETERA/TETERA
80 CL - 27 OZ^{1/16}



207762
CRÉMIER
CREAM JUG
LECHERA
10 CL - 3 OZ^{3/8}



COUVERCLES VERSEUSES
LIDS FOR TEA POTS
TAPAS CAFETERAS

210911 6,6 CM - 2 IN^{5/8} 40 CL - 13 OZ^{1/2}
210912 8,4 CM - 3 IN^{5/16} 80 CL - 27 OZ^{1/16}



NEWPORT P.184-185



CAFÉTERIE - TEATIME - TÉ CAFÉ





207766
TASSE À ESPRESSO
ESPRESSO CUP
ESPRESSO DE TAZA
6 CL - 2 OZ

161025
SOUCOUBE À CAFÉ/ ESPRESSO
DEMITASSE/ESPRESSO SAUCER
ESPRESSO DE PLATO
15 CM - 5 IN^{7/8}



208948
TASSE À CAFÉ
DEMITASSE CUP
TAZA DE CAFÉ
11 CL - 3 OZ^{3/4}

161028
SOUCOUBE À THÉ/LUNGO
COFFEE/TEA SAUCER
LUNGO DE PLATO
18 CM - 7 IN^{1/16}



207768
TASSE À DÉJEUNER
BREAKFAST CUP
TAZA DESAYUNO
48 CL - 16 OZ^{1/4}

161034
SOUCOUBE À DÉJEUNER
BREAKFAST SAUCER
PLATO DESAYUNO
21 CM - 8 IN^{1/4}



207765
MUG
MUG, LARGE
MUG
50 CL - 16 OZ^{15/16}

209189
MUG
MUG
MUG
30 CL - 10 OZ^{1/8}

BAHIA Grés – Stoneware – Arenisca

TASSE À ESPRESSO
ESPRESSO CUP
TAZA DE ESPRESSO
11 CL - 3 OZ^{3/4}



236557



230974



230929



230946



230960



230912

TASSE À THÉ
COFFEE/TEA CUP
TAZA DE TÉ
20 CL - 6 OZ^{3/4}



236559



230976



230931



230948



230962



230914

MUG À THÉ
TEA MUG
MUG
38 CL - 12 OZ^{7/8}



230975



230930



230947



230961



230913

NEW

ONYX
ONYX
ONYX

BLEU DE ROCHE
BLUE STONE
AZUL DE ROCA

DUNE
BEIGE DUNE
BEIS DUNA

BASALTE
BASALT BROWN
BASALTO

ARGILE VERTE
GREEN CLAY
ARCILLA VERDE

ROSE SABLE
PINK SAND
ROSA ARENA

CAFÉTERIE - TEATIME - TÉ CAFÉ



MODULO NATURE Grés – Stoneware – Arenisca



194459 **TASSE À CAFÉ**
DEMITASSE CUP
TAZA DE CAFÉ
11,5 CL - 3 OZ^{7/8}

194460 **SOUCOUE À CAFÉ**
DEMITASSE SAUCER
ESPRESSO CAFÉ
12,5 CM - 4 IN^{5/16}



230093 **TASSE À THÉ**
TEA CUP
TAZA DE TÈ
25 CL - 8 OZ^{7/16}

230094 **SOUCOUE À THÉ**
DEMITASSE/TEA SAUCER
PLATO TÉ
15 CM - 5 OZ^{7/8}



194461 **MUG À THÉ**
MUG
TÈ MUG
33 CL - 11 OZ^{3/16}



184081 **TASSE À CAFÉ**
DEMITASSE CUP
TAZA DE CAFÉ
11,5 CL - 3 OZ^{7/8}

184082 **SOUCOUE À CAFÉ**
DEMITASSE SAUCER
ESPRESSO CAFÉ
12,5 CM - 4 IN^{5/16}



230163 **TASSE À THÉ**
TEA CUP
TAZA DE TÈ
25 CL - 8 OZ^{7/16}

230164 **SOUCOUE À THÉ**
DEMITASSE/TEA SAUCER
PLATO TÉ
15 CM - 5 OZ^{7/8}



184083 **MUG À THÉ**
MUG
TÈ MUG
33 CL - 11 OZ^{3/16}



225351 **TASSE À CAFÉ**
DEMITASSE CUP
TAZA DE CAFÉ
11,5 CL - 3 OZ^{7/8}

225352 **SOUCOUE À CAFÉ**
DEMITASSE SAUCER
ESPRESSO CAFÉ
12,5 CM - 4 IN^{5/16}



230167 **TASSE À THÉ**
TEA CUP
TAZA DE TÈ
25 CL - 8 OZ^{7/16}

230168 **SOUCOUE À THÉ**
DEMITASSE/TEA SAUCER
PLATO TÉ
15 CM - 5 OZ^{7/8}



184094 **TASSE À CAFÉ**
DEMITASSE CUP
TAZA DE CAFÉ
11,5 CL - 3 OZ^{7/8}

184095 **SOUCOUE À CAFÉ**
DEMITASSE SAUCER
ESPRESSO CAFÉ
12,5 CM - 4 IN^{5/16}



230165 **TASSE À THÉ**
TEA CUP
TAZA DE TÈ
25 CL - 8 OZ^{7/16}

230166 **SOUCOUE À THÉ**
DEMITASSE/TEA SAUCER
PLATO TÉ
15 CM - 5 OZ^{7/8}



184096 **MUG À THÉ**
MUG
TÈ MUG
33 CL - 11 OZ^{3/16}

API Porcelaine – Porcelain – Porcelana



207131 **ASSIETTE PLATE RECTANGLE**
6 COMPARTIMENTS
RECTANGULAR DINNER PLATE
6 COMPARTMENTS
PLATO RECTANGULAR/6 COMPARTIMENTOS
27X18 CM - 10 IN^{3/8} X 7 IN^{1/16}



207133 **SOUCOUE RECTANGULAIRE**
RECTANGULAR PLATE/ SAUCER
PLATO RECTANGULAR
27X9 CM - 10 IN^{5/8} X 3 IN^{9/16}

CAFÉTERIE - TEATIME - TÉ CAFÉ







COUVERTS

Les ateliers DEGRENNE donnent forme aux majestueuses bobines d'acier inoxydable et transforment la matière brute en couverts. Les couverts DEGRENNE bénéficient d'un **savoir-faire unique** et se caractérisent par une **ergonomie et une résistance exceptionnelle**. Faciles d'entretien, ils répondent aux critères les plus exigeants de **qualité, de fonctionnalité et d'esthétique** : la qualité du design et le soin apporté aux finitions font de chacun de nos couverts de **véritables pièces d'orfèvre de style classique ou contemporain**. Créé en collaboration avec des chefs ou en laissant libre cours à l'imagination de nos designers, aux lignes sobres ou plus élaborées, **chaque modèle DEGRENNE trouve sa place à table**.

FLATWARE

DEGRENNE'S workshops shape the impressive reels of stainless steel and transform the raw material into cutlery. We use our **unique expertise** to create our cutlery, which is characterized by being extraordinarily **easy to use and sturdy**. DEGRENNE cutlery is easy to look after and meets the most stringent **quality, functionality and appearance criteria**. The design quality and painstaking finishes make each of our items of cutlery **true pieces of classic or contemporary silverware**. DEGRENNE cutlery is designed in partnership with chefs or by giving our designers free rein. Some items have simple lines, while others are more elaborate, but **every DEGRENNE design takes pride of place on a table**.

CUBIERTOS

Los talleres DEGRENNE dan forma a las majestuosas bobinas de acero inoxidable y transforman la materia bruta en cubiertos. Los cubiertos DEGRENNE se benefician de un **saber hacer único** y se caracterizan por una **ergonomía y una resistencia excepcional**. Fáciles de mantener, responden a los criterios más exigentes de **calidad, de funcionalidad y de estética** : La calidad del diseño y el cuidado aportado a los acabados hacen que cada uno de nuestros cubiertos sea una **verdadera pieza de orfebrería de estilo clásico o contemporáneo**. Creado en colaboración con chefs o dando rienda suelta a la imaginación de nuestros diseñadores, con líneas sobrias o más elaboradas, **cada modelo DEGRENNE encuentra su lugar en la mesa**.







COLLECTIONS DESIGN

XY BLACK MIROIR
195039 - FOURCHETTE MISE EN BOUCHE - COCKTAIL FORK - TENEDOR PARA APERITIVO P. 102-103





205559
FOURCHETTE DE TABLE
TABLE FORK
TENEDOR DE MESA
21,3 CM - 8 IN^{3/8}



193776
COUTEAU DE TABLE MONOBLOC LAME SCIE
TABLE KNIFE SOLID HANDLE SERRATED
CUCHILLO DE MESA HOJA SIERRA
23,3 CM - 9 IN^{3/16}



205560
CUILLÈRE DE TABLE
TABLE/PASTA SPOON
CUCHARA DE MESA
20,5 CM - 8 IN^{1/16}



205561
CUILLÈRE À SOUPE ANGLAISE
BOUILLON SPOON, ROUND
CUCHARA DE CONSOMÉ
18,5 CM - 7 IN^{5/16}



205567
CUILLÈRE GOURMANDE
DESSERT /SOUP SPOON, OVAL
CUCHARA DE POSTRE
18,6 CM - 7 IN^{5/16}



205566
FOURCHETTE GOURMANDE
DESSERT /SALAD FORK
TENEDOR DE POSTRE
18,6 CM - 7 IN^{5/16}



181111
COUTEAU À DESSERT MONOBLOC LAME UNIE
DESSERT KNIFE SOLID HANDLE
CUCHILLO DE POSTRE HOJA LISA
20,6 CM - 8 IN^{1/8}



181112
TARTINEUR
BUTTER SPREADER
ESPATULÍN PARA MANTEQUILLA
16 CM - 6 IN^{5/16}



205563
FOURCHETTE À POISSON
FISH FORK
TENEDOR DE PESCADO
20 CM - 7 IN^{7/8}



205564
SPATULE GOURMET
GOURMET SPATULA
ESPÁTULA GOURMET
20,2 CM - 7 IN^{15/16}



205565
FOURCHETTE GOURMET
GOURMET FORK
TENEDOR GOURMET
20 CM - 7 IN^{7/8}



205562
CUILLÈRE À CAFÉ
COFFEE/TEA SPOON
CUCHARA DE CAFÉ
14,3 CM - 5 IN^{5/8}



181109
CUILLÈRE À MOKA
DEMI TASSE SPOON
CUCHARA DE MOKA
11 CM - 4 IN^{5/16}



190018
CUILLÈRE À SODA
ICED TEA SPOON
CUCHARA DE SODA/HELADO
19 CM - 7 IN^{1/2}



181119
FOURCHETTE MISE EN BOUCHE
COCKTAIL FORK
TENEDOR PARA APERITIVO
15,5 CM - 6 IN^{1/8}



181120
SPATULE MISE EN BOUCHE
COCKTAIL SPATULA
ESPÁTULA PARA APERITIVO
15,5 CM - 6 IN^{1/8}



181121
CUILLÈRE MISE EN BOUCHE
COCKTAIL SPOON
CUCHARA PARA APERITIVO
11,6 CM - 4 IN^{3/16}



190424
FOURCHETTE À HÙÎTRES
OYSTER FORK
TENEDOR DE OSTRAS
14,5 CM - 5 IN^{11/16}



181114
FOURCHETTE DE SERVICE
SERVING FORK
TENEDOR DE SERVICIO/ENSALADA
26 CM - 10 IN^{1/4}



181113
CUILLÈRE DE SERVICE
SERVING SPOON
CUCHARA DE SERVICIO/ENSALADA
26 CM - 10 IN^{1/4}



181122
SPATULE DE SERVICE
SERVING SPATULA
ESPÁTULA DE SERVICIO/ENSALADA
25 CM - 9 IN^{13/16}



189999
SERVICE À SALADE
SALAD SERVING SET
SET SERVICIO DE ENSALADA
30 CM - 11 IN^{13/16}



153193
LOUCHE
SOUP LADLE
CAZO
29,7 CM - 11 IN^{11/16}



154606
LOUCHE À SAUCE
SAUCE LADLE
CUCHARA SALSA
18,5 CM - 7 IN^{5/16}

Possibilité de personnalisation
Bespoke options available - Posibilidad de personalización



XY MIROIR





205568
FOURCHETTE DE TABLE
TABLE FORK
TENEDOR DE MESA
21,3 CM - 8 IN^{3/8}



195034
CUILLÈRE À MOKA
DEMI TASSE SPOON
CUCHARA DE MOKA
11 CM - 4 IN^{5/16}



195028
COUTEAU DE TABLE MONOBLOC LAME SCIE
TABLE KNIFE SOLID HANDLE SERRATED
CUCHILLO DE MESA HOJA SIERRA
23,3 CM - 9 IN^{3/16}



196674
CUILLÈRE À SODA
ICED TEA SPOON
CUCHARA DE SODA/HELADO
19 CM - 7 IN^{1/2}



205569
CUILLÈRE DE TABLE
TABLE/PASTA SPOON
CUCHARA DE MESA
20,5 CM - 8 IN^{1/16}



195039
FOURCHETTE MISE EN BOUCHE
COCKTAIL FORK
TENEDOR PARA APERITIVO
15,5 CM - 6 IN^{5/8}



200483
CUILLÈRE À SOUPE ANGLAISE
BOUILLON SPOON, ROUND
CUCHARA DE CONSOMÉ
18,5 CM - 7 IN^{5/16}



195042
SPATULE MISE EN BOUCHE
COCKTAIL SPATULA
ESPÁTULA PARA APERITIVO
15,5 CM - 6 IN^{5/8}



205575
CUILLÈRE GOURMANDE
DESSERT /SOUP SPOON, OVAL
CUCHARA DE POSTRE
18,6 CM - 7 IN^{5/16}



195041
CUILLÈRE MISE EN BOUCHE
COCKTAIL SPOON
CUCHARA PARA APERITIVO
11,6 CM - 4 IN^{9/16}



205574
FOURCHETTE GOURMANDE
DESSERT /SALAD FORK
TENEDOR DE POSTRE
18,6 CM - 7 IN^{5/16}



196014
FOURCHETTE À HÙÎTRES
OYSTER FORK
TENEDOR DE OSTRAS
14,1 CM - 5 IN^{9/16}



195031
COUTEAU À DESSERT MONOBLOC LAME UNIE
DESSERT KNIFE SOLID HANDLE
CUCHILLO DE POSTRE HOJA LISA
20,6 CM - 8 IN^{1/8}



199773
FOURCHETTE DE SERVICE
SERVING FORK
TENEDOR DE SERVICIO/ENSALADA
26 CM - 10 IN^{1/4}



195036
TARTINEUR
BUTTER SPREADER
ESPATULÍN PARA MANTEQUILLA
16 CM - 6 IN^{5/16}



199774
CUILLÈRE DE SERVICE
SERVING SPOON
CUCHARA DE SERVICIO/ENSALADA
26 CM - 10 IN^{1/4}



205571
FOURCHETTE À POISSON
FISH FORK
TENEDOR DE PESCADO
20 CM - 7 IN^{7/8}



199769
SPATULE DE SERVICE
SERVING SPATULA
ESPÁTULA DE SERVICIO/ENSALADA
25 CM - 9 IN^{13/16}



205572
SPATULE GOURMET
GOURMET SPATULA
ESPÁTULA GOURMET
20,2 CM - 7 IN^{15/16}



199771
SERVICE À SALADE
SALAD SERVING SET
SET SERVICIO DE ENSALADA
30 CM - 11 IN^{13/16}



205573
FOURCHETTE GOURMET
GOURMET FORK
TENEDOR GOURMET
20 CM - 7 IN^{7/8}



205570
CUILLÈRE À CAFÉ
COFFEE/TEA SPOON
CUCHARA DE CAFÉ
14,3 CM - 5 IN^{5/8}



XY BLACK MIROIR

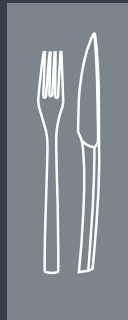



143770
FOURCHETTE DE TABLE
TABLE FORK
TENEDOR DE MESA
20,9 CM - 8 IN^{3/16}



159484
**COUTEAU DE TABLE
MONOBLOC LAME SCIE**
TABLE KNIFE SOLID HANDLE SERRATED
CUCHILLO DE MESA HOJA SIERRA
23,2 CM - 9 IN^{1/8}



208624
**COUTEAU DE TABLE
MONOBLOC LAME SCIE**
TABLE KNIFE SOLID HANDLE SERRATED
CUCHILLO DE MESA HOJA SIERRA
23 CM - 9 IN^{1/16}



159451
**COUTEAU À STEAK
MONOBLOC LAME SCIE**
STEAK KNIFE SOLID HANDLE SERRATED
CUCHILLO DE STEAK HOJA SIERRA
23,5 CM - 9 IN^{1/4}



143767
CUILLÈRE DE TABLE
TABLE/PASTA SPOON
CUCHARA DE MESA
21,2 CM - 8 IN^{5/8}



148852
CUILLÈRE À SOUPE ANGLAISE
BOUILLON SPOON, ROUND
CUCHARA DE CONSOMÉ
17,1 CM - 6 IN^{3/4}



143801
CUILLÈRE À DESSERT
DESSERT /SOUP SPOON, OVAL
CUCHARA DE POSTRE
18,7 CM - 7 IN^{3/8}



143804
FOURCHETTE À DESSERT
DESSERT /SALAD FORK
TENEDOR DE POSTRE
18,4 CM - 7 IN^{1/4}



159492
**COUTEAU À DESSERT
MONOBLOC LAME UNIE**
DESSERT KNIFE SOLID HANDLE
CUCHILLO DE POSTRE HOJA LISA
20,4 CM - 8 IN^{1/16}



208625
**COUTEAU À DESSERT
MONOBLOC LAME SCIE**
DESSERT KNIFE SOLID HANDLE
SERRATED
CUCHILLO DE POSTRE
HOJA SIERRA
20,7 CM - 8 IN^{1/8}



181112
TARTINEUR
BUTTER SPREADER
ESPATULÍN PARA MANTEQUILLA
16 CM - 6 IN^{5/16}



143790
FOURCHETTE À POISSON
FISH FORK
TENEDOR DE PESCADO
18,5 CM - 7 IN^{5/16}



181467
COUTEAU À POISSON/GOURMET
GOURMET FISH KNIFE
CUCHILLO DE PESCADO
20,1 CM - 7 IN^{5/16}



143772
CUILLÈRE À CAFÉ
COFFEE/TEA SPOON
CUCHARA DE CAFÉ
14,9 CM - 5 IN^{7/8}



148855
CUILLÈRE À MOKA
DEMI TASSE SPOON
CUCHARA DE MOKA
11 CM - 4 IN^{5/16}



190018
CUILLÈRE À SODA
ICED TEA SPOON
CUCHARA DE SODA/HELADO
19 CM - 7 IN^{1/2}



143782
FOURCHETTE À GÂTEAUX/COCKTAIL
PASTRY/COCKTAIL FORK
TENEDOR DE PASTEL
14,9 CM - 5 IN^{7/8}



190424
FOURCHETTE À HÙÎTRES
OYSTER FORK
TENEDOR DE OSTRAS
14,1 CM - 5 IN^{9/16}



197522
FOURCHETTE DE SERVICE
SERVING FORK
TENEDOR DE SERVICIO/ENSALADA
26,6 CM - 10 IN^{1/2}



197523
CUILLÈRE DE SERVICE
SERVING SPOON
CUCHARA DE SERVICIO/ENSALADA
27 CM - 10 IN^{5/8}



197525
SERVICE À SALADE
SALAD SERVING SET
SET SERVICIO DE ENSALADA
30 CM - 11 IN^{13/16}



197527
PELLE À TARTE MONOBLOC
PASTRY SERVER SOLID HANDLE
PALA PARA TARTA
25,1 CM - 9 IN^{7/8}



153193
LOUCHE
SOUP LADLE
CAZO
29,7 CM - 11 IN^{11/16}



154606
LOUCHE À SAUCE
SAUCE LADLE
CAZO DE SALSA
18,5 CM - 7 IN^{5/16}

Possibilité de personnalisation
Bespoke options available - Posibilidad de personalización



SERENITY



DEGRENE



205540
FOURCHETTE DE TABLE
TABLE FORK
TENEDOR DE MESA
20,9 CM - 8 IN^{3/16}



159484
COUTEAU DE TABLE MONOBLOC LAME SCIE
TABLE KNIFE SOLID HANDLE SERRATED
CUCHILLO DE MESA HOJA SIERRA
23,2 CM - 9 IN^{1/8}



208624
COUTEAU DE TABLE MONOBLOC LAME SCIE
TABLE KNIFE SOLID HANDLE SERRATED
CUCHILLO DE MESA HOJA SIERRA
23 CM - 9 IN^{1/16}



159451
COUTEAU À STEAK MONOBLOC LAME SCIE
STEAK KNIFE SOLID HANDLE SERRATED
CUCHILLO DE STEAK HOJA SIERRA
23,5 CM - 9 IN^{1/4}



205541
CUILLÈRE DE TABLE
TABLE/PASTA SPOON
CUCHARA DE MESA
20,9 CM - 8 IN^{1/4}



205542
CUILLÈRE À SOUPE ANGLAISE
BOUILLON SPOON, ROUND
CUCHARA DE CONSOMÉ
17,8 CM - 7 IN



205547
CUILLÈRE À DESSERT
DESSERT /SOUP SPOON, OVAL
CUCHARA DE POSTRE
18,4 CM - 7 IN^{1/4}



205546
FOURCHETTE À DESSERT
DESSERT /SALAD FORK
TENEDOR DE POSTRE
18,4 CM - 7 IN^{1/4}



159492
COUTEAU À DESSERT MONOBLOC LAME UNIE
DESSERT KNIFE SOLID HANDLE
CUCHILLO DE POSTRE HOJA LISA
20,4 CM - 8 IN^{1/16}



208625
COUTEAU À DESSERT MONOBLOC LAME SCIE
DESSERT KNIFE SOLID HANDLE
SERRATED
CUCHILLO DE POSTRE HOJA SIERRA
20,7 CM - 8 IN^{1/8}



154612
COUTEAU À BEURRE MONOBLOC LAME UNIE
BUTTER KNIFE SOLID HANDLE
CUCHILLO DE MANTEQUILLA HOJA LISA
19,4 CM - 7 IN^{5/8}



205544
FOURCHETTE À POISSON
FISH FORK
TENEDOR DE PESCADO
18,4 CM - 7 IN^{1/4}



205545
COUTEAU À POISSON/GOURMET
GOURMET FISH KNIFE
CUCHILLO DE PESCADO
20,7 CM - 8 IN^{1/8}



205543
CUILLÈRE À CAFÉ
COFFEE/TEA SPOON
CUCHARA DE CAFÉ
14 CM - 5 IN^{1/2}



159512
CUILLÈRE À MOKA
DEMI TASSE SPOON
CUCHARA DE MOKA
11,1 CM - 4 IN^{3/8}



190018
CUILLÈRE À SODA
ICED TEA SPOON
CUCHARA DE SODA/HELADO
19 CM - 7 IN^{1/2}



205548
FOURCHETTE À GÂTEAUX/COCKTAIL
PASTRY/COCKTAIL FORK
TENEDOR DE PASTEL
14,1 CM - 5 IN^{9/16}



190424
FOURCHETTE À HÙÎTRES
OYSTER FORK
TENEDOR DE OSTRAS
14,5 CM - 5 IN^{11/16}



159501
FOURCHETTE DE SERVICE
SERVING FORK
TENEDOR DE SERVICIO/ENSALADA
26 CM - 10 IN^{1/4}



159500
CUILLÈRE DE SERVICE
SERVING SPOON
CUCHARA DE SERVICIO/ENSALADA
26 CM - 10 IN^{1/4}

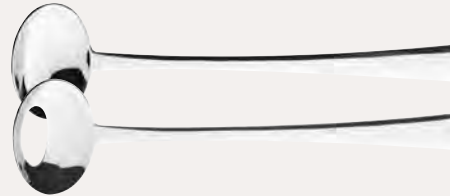

159504
SERVICE À SALADE
SALAD SERVING SET
SET SERVICIO DE ENSALADA
30 CM - 11 IN^{13/16}



159490
PELLE À TARTE MONOBLOC
PASTRY SERVER SOLID HANDLE
PALA PARA TARTA
26,2 CM - 10 IN^{1/4}



153193
LOUCHE
SOUP LADLE
CAZO
29,7 CM - 11 IN^{11/16}



154606
CUILLÈRE À SAUCE
SAUCE SPOON
CUCHARA DE SALSA
18,5 CM - 7 IN^{5/16}

Possibilità de personalisation
Bespoke options available - Posibilidad de personalización



All day dining

SOLSTICE

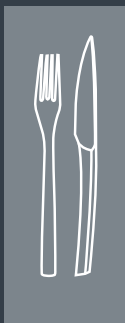



233011
FOURCHETTE DE TABLE
TABLE FORK
TENEDOR DE MESA
20,5 CM - 8 IN^{1/16}



233013
**COUTEAU DE TABLE
MONOBLOC À BOUT POINTU
LAME SCIE**
TABLE KNIFE SOLID HANDLE POINTED
BLADE SERRATED
CUCHILLO DE MESA HOJA SIERRA
23,3 CM - 9 IN^{3/16}



233014
**COUTEAU DE TABLE
MONOBLOC À BOUT ROND
LAME SCIE**
TABLE KNIFE SOLID HANDLE ROUNDED
BLADE SERRATED
CUCHILLO DE MESA HOJA SIERRA
23,3 CM - 9 IN^{3/16}



229520
**COUTEAU DE TABLE
MANCHE ORFÈVRE LAME UNIE**
TABLE KNIFE HOLLOW HANDLE
CUCHILLO DE MESA ENMANGADO
HOJA LISA
23,3 CM - 9 IN^{3/16}



233012
CUILLÈRE DE TABLE
TABLE/PASTA SPOON
CUCHARA DE MESA
20,5 CM - 8 IN^{1/16}



233022
CUILLÈRE À SOUPE ANGLAISE
BOUILLON SPOON, ROUND
CUCHARA DE CONSOMÉ
18,5 CM - 7 IN^{5/16}



233018
CUILLÈRE À DESSERT
DESSERT /SOUP SPOON, OVAL
CUCHARA DE POSTRE
18,5 CM - 7 IN^{5/16}



233017
FOURCHETTE À DESSERT
DESSERT /SALAD FORK
TENEDOR DE POSTRE
18,5 CM - 7 IN^{5/16}



233019
**COUTEAU À DESSERT
MONOBLOC À BOUT ROND
LAME UNIE**
DESSERT KNIFE SOLID HANDLE
ROUNDED BLADE
CUCHILLO DE POSTRE HOJA LISA
20,9 CM - 8 IN^{1/4}



233023
**COUTEAU À BEURRE
MONOBLOC LAME UNIE**
BUTTER KNIFE SOLID HANDLE
CUCHILLO DE MANTEQUILLA
HOJA LISA
17,5 CM - 6 IN^{7/8}



233021
CUILLÈRE GOURMET
GOURMET SPOON
CUCHARA PARA SALSAS
18,5 CM - 7 IN^{5/16}



233015
CUILLÈRE À CAFÉ
COFFEE/TEA SPOON
CUCHARA DE CAFÉ
13,9 CM - 5 IN^{1/2}



233016
CUILLÈRE À MOKA
DEMI TASSE SPOON
CUCHARA DE MOKA
11,7 CM - 4 IN^{5/8}



233020
**FOURCHETTE À GÂTEAUX/
COCKTAIL**
PASTRY/COCKTAIL FORK
TENEDOR DE PASTEL
13,9 CM - 5 IN^{1/2}



233024
FOURCHETTE DE SERVICE
SERVING FORK
TENEDOR DE SERVICIO/ENSALADA
26,3 CM - 10 IN^{3/8}



233025
CUILLÈRE DE SERVICE
SERVING SPOON
CUCHARA DE SERVICIO/ENSALADA
26,3 CM - 10 IN^{3/8}







197507
FOURCHETTE DE TABLE
TABLE FORK
TENEDOR DE MESA
21,3 CM - 8 IN^{3/8}



197509
COUTEAU DE TABLE MONOBLOC LAME SCIE
TABLE KNIFE SOLID HANDLE SERRATED
CUCHILLO DE MESA HOJA SIERRA
23,2 CM - 9 IN^{1/8}



235481 **NEW**
COUTEAU DE TABLE MONOBLOC LAME SCIE
TABLE KNIFE SOLID HANDLE SERRATED
CUCHILLO DE MESA HOJA SIERRA
23,7 CM - 9 IN^{5/16}



197521
COUTEAU À STEAK MONOBLOC LAME SCIE
STEAK KNIFE SOLID HANDLE SERRATED
CUCHILLO DE STEAK HOJA SIERRA
23,2 CM - 9 IN^{1/8}



197506
CUILLÈRE DE TABLE
TABLE/PASTA SPOON
CUCHARA DE MESA
21,6 CM - 8 IN^{1/2}



197518
CUILLÈRE À SOUPE ANGLAISE
BOUILLON SPOON, ROUND
CUCHARA DE CONSOMÉ
18,5 CM - 7 IN^{5/16}



197512
CUILLÈRE À DESSERT
DESSERT/SOUP SPOON, OVAL
CUCHARA DE POSTRE
19,5 CM - 7 IN^{11/16}



197511
FOURCHETTE À DESSERT
DESSERT/SALAD FORK
TENEDOR DE POSTRE
19,2 CM - 7 IN^{9/16}



210629
COUTEAU À DESSERT MONOBLOC LAME SCIE
DESSERT KNIFE SOLID HANDLE SERRATED
CUCHILLO DE POSTRE HOJA SIERRA
20,9 CM - 8 IN^{3/16}



235482 **NEW**
COUTEAU À DESSERT MONOBLOC LAME UNIE
DESSERT KNIFE SOLID HANDLE
CUCHILLO DE POSTRE HOJA LISA
21,3 CM - 8 IN^{3/16}



197520
COUTEAU À BEURRE MONOBLOC LAME UNIE
BUTTER KNIFE SOLID HANDLE
CUCHILLO PARA MANTEQUILLA HOJA LISA
19,3 CM - 7 IN^{5/8}



197514
FOURCHETTE À POISSON
FISH FORK
TENEDOR DE PESCADO
19,2 CM - 7 IN^{9/16}



197515
COUTEAU À POISSON/GOURMET
GOURMET FISH KNIFE
CUCHILLO DE PESCADO
21,3 CM - 8 IN^{3/8}



197508
CUILLÈRE À CAFÉ
COFFEE/TEA SPOON
CUCHARA DE CAFÉ
14,3 CM - 5 IN^{5/8}



197510
CUILLÈRE À MOKA
DEMI TASSE SPOON
CUCHARA DE MOKA
11,7 CM - 4 IN^{5/8}



190018
CUILLÈRE À SODA
ICED TEA SPOON
CUCHARA DE SODA/HELADO
19 CM - 7 IN^{1/2}



197516
FOURCHETTE À GÂTEAUX/COCKTAIL
PASTRY/COCKTAIL FORK
TENEDOR DE PASTEL
13,9 CM - 5 IN^{1/2}



190424
FOURCHETTE À HÙÎTRES
OYSTER FORK
TENEDOR DE OSTRAS
14,1 CM - 5 IN^{9/16}



197522
FOURCHETTE DE SERVICE
SERVING FORK
TENEDOR DE SERVICIO/ENSALADA
26,6 CM - 10 IN^{1/2}



197523
CUILLÈRE DE SERVICE
SERVING SPOON
CUCHARA DE SERVICIO/ENSALADA
27 CM - 10 IN^{5/8}



197525
SERVICE À SALADE
SALAD SERVING SET
SET SERVICIO DE ENSALADA
30 CM - 11 IN^{13/16}



197527
PELLE À TARTE MONOBLOC
PASTRY SERVER SOLID HANDLE
PALA PARA TARTA
25,1 CM - 9 IN^{7/8}



153193
LOUCHE
SOUP LADLE
CAZO
29,7 CM - 11 IN^{11/16}



154606
CUILLÈRE À SAUCE
SAUCE LADLE
CAZO DE SALSA
18,5 CM - 7 IN^{5/16}

Possibilité de personnalisation
Bespoke options available - Posibilidad de personalización



©Patrick ROUGEREAU
L'abus d'alcool est dangereux pour la santé
Degrimez responsable drinking and discouraging alcohol misuse
El abuso de alcohol es peligroso para la salud

GUEST MIROIR





223482
FOURCHETTE DE TABLE
TABLE FORK
TENEDOR DE MESA
21,3 CM - 8 IN^{3/8}



223483
CUILLÈRE À CAFÉ
COFFEE/TEA SPOON
CUCHARA DE CAFÉ
14,3 CM - 5 IN^{5/8}



202995
COUTEAU DE TABLE MONOBLOC LAME SCIE
TABLE KNIFE SOLID HANDLE SERRATED
CUCHILLO DE MESA HOJA SIERRA
23,2 CM - 9 IN^{1/8}



223484
CUILLÈRE À MOKA
DEMI TASSE SPOON
CUCHARA DE MOKA
11,7 CM - 4 IN^{5/8}



203017
COUTEAU À STEAK MONOBLOC LAME SCIE
STEAK KNIFE SOLID HANDLE SERRATED
CUCHILLO DE STEAK HOJA SIERRA
23,2 CM - 9 IN^{1/8}



223492
CUILLÈRE À SODA
ICED TEA SPOON
CUCHARA DE SODA/HELADO
18,9 CM - 7 IN^{7/16}



223481
CUILLÈRE DE TABLE
TABLE/PASTA SPOON
CUCHARA DE MESA
21,6 CM - 8 IN^{1/2}



223489
FOURCHETTE À GÂTEAUX/COCKTAIL
PASTRY/COCKTAIL FORK
TENEDOR DE PASTEL
13,9 CM - 5 IN^{1/2}



223491
CUILLÈRE À SOUPE ANGLAISE
BOUILLON SPOON, ROUND
CUCHARA DE CONSOMÉ
18,5 CM - 7 IN^{5/16}



223493
FOURCHETTE DE SERVICE
SERVING FORK
TENEDOR DE SERVICIO/ENSALADA
26,6 CM - 10 IN^{1/2}



223486
CUILLÈRE À DESSERT
DESSERT/SOUP SPOON, OVAL
CUCHARA DE POSTRE
19,5 CM - 7 IN^{17/16}



223494
CUILLÈRE DE SERVICE
SERVING SPOON
CUCHARA DE SERVICIO/ENSALADA
27 CM - 10 IN^{5/8}



223485
FOURCHETTE À DESSERT
DESSERT/SALAD FORK
TENEDOR DE POSTRE
19,2 CM - 7 IN^{9/16}

223496
SERVICE À SALADE
SALAD SERVING SET
SET SERVICIO DE ENSALADA
30 CM - 11 IN^{13/16}



210630
COUTEAU À DESSERT MONOBLOC LAME SCIE
DESSERT KNIFE SOLID HANDLE
SERRATED
CUCHILLO DE POSTRE HOJA SIERRA
20,9 CM - 8 IN^{3/16}



223497
PELLE À TARTE MONOBLOC
PASTRY SERVER SOLID HANDLE
PALA PARA TARTA
25,1 CM - 9 IN^{7/8}



203016
COUTEAU À BEURRE MONOBLOC LAME UNIE
BUTTER KNIFE SOLID HANDLE
CUCHILLO PARA MANTEQUILLA HOJA LISA
19,3 CM - 7 IN^{5/8}



223487
FOURCHETTE À POISSON
FISH FORK
TENEDOR DE PESCADO
19,2 CM - 7 IN^{9/16}



223488
COUTEAU À POISSON/GOURMET
GOURMET FISH KNIFE
CUCHILLO DE PESCADO
21,3 CM - 8 IN^{3/8}



18-10



GUEST STAR





230848
FOURCHETTE DE TABLE
 TABLE FORK
 TENEDOR DE MESA
 21,3 CM - 8 IN^{3/8}



230850
**COUTEAU DE TABLE
 MONOBLOC LAME SCIE**
 TABLE KNIFE SOLID HANDLE SERRATED
 CUCHILLO DE MESA HOJA SIERRA
 23,2 CM - 9 IN^{1/8}



230849
CUILLÈRE DE TABLE
 TABLE/PASTA SPOON
 CUCHARA DE MESA
 21,6 CM - 8 IN^{1/2}



230854
CUILLÈRE À DESSERT
 DESSERT /SOUP SPOON, OVAL
 CUCHARA DE POSTRE
 19,5 CM - 7 IN^{11/16}



230853
FOURCHETTE À DESSERT
 DESSERT /SALAD FORK
 TENEDOR DE POSTRE
 19,2 CM - 7 IN^{9/16}



230855
**COUTEAU À DESSERT
 MONOBLOC LAME SCIE**
 DESSERT KNIFE SOLID HANDLE
 SERRATED
 CUCHILLO DE POSTRE HOJA SIERRA
 20,9 CM - 8 IN^{3/16}



230851
CUILLÈRE À CAFÉ
 COFFEE/TEA SPOON
 CUCHARA DE CAFÉ
 14,3 CM - 5 IN^{5/8}



230852
CUILLÈRE À MOKA
 DEMI TASSE SPOON
 CUCHARA DE MOKA
 11,7 CM - 4 IN^{5/8}



©Patrick ROUGEREAU

Finedining

GUEST CUIVRE COPPER

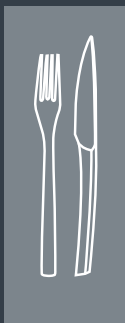



217139
FOURCHETTE DE TABLE
 TABLE FORK
 TENEDOR DE MESA
 21,3 CM - 8 IN^{3/8}



217140
**COUTEAU DE TABLE
 MONOBLOC LAME SCIE**
 TABLE KNIFE SOLID HANDLE SERRATED
 CUCHILLO DE MESA HOJA SIERRA
 23,2 CM - 9 IN^{1/8}



230339
**COUTEAU À STEAK
 MONOBLOC LAME SCIE**
 STEAK KNIFE SOLID HANDLE SERRATED
 CUCHILLO DE STEAK HOJA SIERRA
 23,2 CM - 9 IN^{1/8}



217141
CUILLÈRE DE TABLE
 TABLE/PASTA SPOON
 CUCHARA DE MESA
 21,6 CM - 8 IN^{1/2}



217143
CUILLÈRE À DESSERT
 DESSERT /SOUP SPOON, OVAL
 CUCHARA DE POSTRE
 19,5 CM - 7 IN^{11/16}



217144
FOURCHETTE À DESSERT
 DESSERT /SALAD FORK
 TENEDOR DE POSTRE
 19,2 CM - 7 IN^{9/16}



217145
**COUTEAU À DESSERT
 MONOBLOC LAME SCIE**
 DESSERT KNIFE SOLID HANDLE
 SERRATED
 CUCHILLO DE POSTRE HOJA SIERRA
 20,9 CM - 8 IN^{3/16}



232307
TARTINEUR
 BUTTER SPREADER
 ESPATULIN PARA MANTEQUILLA
 16 CM - 6 IN^{5/16}



230411
FOURCHETTE À POISSON
 FISH FORK
 TENEDOR DE PESCADO
 19,2 CM - 7 IN^{9/16}



230412
COUTEAU POISSON/GOURMET
 GOURMET/FISH KNIFE
 CUCHILLO DE PESCADO
 21,3 CM - 8 IN^{3/8}



217142
CUILLÈRE À CAFÉ
 COFFEE/TEA SPOON
 CUCHARA DE CAFÉ
 14,3 CM - 5 IN^{5/8}



217146
CUILLÈRE À MOKA
 DEMI TASSE SPOON
 CUCHARA DE MOKA
 11,7 CM - 4 IN^{5/8}



©Patrick ROUGEREAU



GUEST VINTAGE

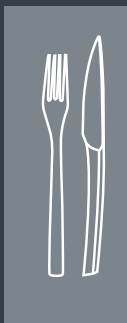



236700
FOURCHETTE DE TABLE
 TABLE FORK
 TENEDOR DE MESA
 21,5 CM - 8 IN^{7/16}



236702
**COUTEAU DE TABLE
 MONOBLOC LAME SCIE**
 TABLE KNIFE SOLID HANDLE SERRATED
 CUCHILLO DE MESA HOJA SIERRA
 21,5 CM - 8 IN^{7/16}



236701
CUILLÈRE DE TABLE
 TABLE/PASTA SPOON
 CUCHARA DE MESA
 21,5 CM - 8 IN^{7/16}



236726
CUILLÈRE À SOUPE ANGLAISE
 BOUILLON SPOON, ROUND
 CUCHARA DE CONSOMÉ
 18,5 CM - 7 IN^{5/16}



236721
CUILLÈRE À DESSERT
 DESSERT /SOUP SPOON, OVAL
 CUCHARA DE POSTRE
 19,1 CM - 7 IN^{1/2}



236719
FOURCHETTE À DESSERT
 DESSERT /SALAD FORK
 TENEDOR DE POSTRE
 19,1 CM - 7 IN^{1/2}



236720
**COUTEAU À DESSERT
 MONOBLOC LAME UNIE**
 DESSERT KNIFE SOLID HANDLE
 CUCHILLO DE POSTRE HOJA LISA
 19,2 CM - 7 IN^{9/16}



236727
TARTINEUR
 BUTTER SPREADER
 ESPATULÍN PARA MANTEQUILLA
 16,5 CM - 6 IN^{1/2}



236703
CUILLÈRE À CAFÉ
 COFFEE/TEA SPOON
 CUCHARA DE CAFÉ
 15 CM - 5 IN^{7/8}



236722
CUILLÈRE À MOKA
 DEMI TASSE SPOON
 CUCHARA DE MOKA
 11 CM - 4 IN^{5/16}



236724
FOURCHETTE DE SERVICE
 SERVING FORK
 TENEDOR DE SERVICIO/ENSALADA
 26 CM - 10 IN^{1/4}



236723
CUILLÈRE DE SERVICE
 SERVING SPOON
 CUCHARA DE SERVICIO/ENSALADA
 26 CM - 10 IN^{1/4}

Possibilité de personnalisation
 Bespoke options available - Posibilidad de personalización



©Patrick ROUGEREAU
 L'abus d'alcool est dangereux pour la santé.
 Degrime promotes responsible drinking and discourages alcohol misuse.
 El abuso de alcohol es peligroso para la salud.

NEW FUSE

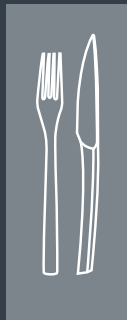



236790
FOURCHETTE DE TABLE
 TABLE FORK
 TENEDOR DE MESA
 21,5 CM - 8 IN^{7/16}



236791
**COUPEAU DE TABLE
 MONOBLOC LAME SCIE**
 TABLE KNIFE SOLID HANDLE SERRATED
 CUCHILLO DE MESA HOJA SIERRA
 21,5 CM - 8 IN^{7/16}



236789
CUILLÈRE DE TABLE
 TABLE/PASTA SPOON
 CUCHARA DE MESA
 21,5 CM - 8 IN^{7/16}



236802
CUILLÈRE À SOUPE ANGLAISE
 BOUILLON SPOON, ROUND
 CUCHARA DE CONSOMÉ
 18,5 CM - 7 IN^{5/16}



236796
CUILLÈRE À DESSERT
 DESSERT /SOUP SPOON, OVAL
 CUCHARA DE POSTRE
 19,1 CM - 7 IN^{1/2}



236794
FOURCHETTE À DESSERT
 DESSERT /SALAD FORK
 TENEDOR DE POSTRE
 19,1 CM - 7 IN^{1/2}



236795
**COUPEAU À DESSERT
 MONOBLOC LAME UNIE**
 DESSERT KNIFE SOLID HANDLE
 CUCHILLO DE POSTRE HOJA LISA
 19,2 CM - 7 IN^{9/16}



236804
TARTINEUR
 BUTTER SPREADER
 ESPATULÍN PARA MANTEQUILLA
 16,5 CM - 6 IN^{1/2}



236798
CUILLÈRE À CAFÉ
 COFFEE/TEA SPOON
 CUCHARA DE CAFÉ
 15 CM - 5 IN^{7/8}



236797
CUILLÈRE À MOKA
 DEMI TASSE SPOON
 CUCHARA DE MOKA
 11 CM - 4 IN^{5/16}



236806
PICAPÉRO
 COCKTAIL PICK
 TENEDOR PARA APERITIVO
 15 CM - 5 IN^{7/8}



236805
**FOURCHETTE/PIQUE À
 ESCARGOTS/COCKTAIL**
 COCKTAIL, SNAIL FORK
 TENEDOR DE CARACOL/COCKTAIL
 15 CM - 5 IN^{7/8}



236800
FOURCHETTE DE SERVICE
 SERVING FORK
 TENEDOR DE SERVICIO/ENSALADA
 26 CM - 10 IN^{1/4}



236799
CUILLÈRE DE SERVICE
 SERVING SPOON
 CUCHARA DE SERVICIO/ENSALADA
 26 CM - 10 IN^{1/4}



NEW FUSE MARTELÉ

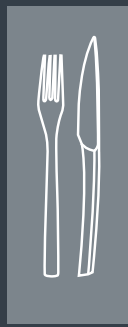



126355
FOURCHETTE DE TABLE
TABLE FORK
TENEDOR DE MESA
20,1 CM - 7 IN^{5/16}



210731
COUPEAU DE TABLE MONOBLOC LAME SCIE
TABLE KNIFE SOLID HANDLE SERRATED
CUCHILLO DE MESA HOJA SIERRA
23,5 CM - 9 IN^{1/4}



207189
COUPEAU À STEAK MONOBLOC LAME SCIE
STEAK KNIFE SOLID HANDLE SERRATED
CUCHILLO DE STEAK HOJA SIERRA
23,6 CM - 9 IN^{5/16}



126352
CUILLÈRE DE TABLE
TABLE/PASTA SPOON
CUCHARA DE MESA
20,3 CM - 8 IN



140855
CUILLÈRE À SOUPE ANGLAISE
BOUILLON SPOON, ROUND
CUCHARA DE CONSOMÉ
17,9 CM - 7 IN^{1/16}



126368
CUILLÈRE À DESSERT
DESSERT /SOUP SPOON, OVAL
CUCHARA DE POSTRE
17,8 CM - 7 IN



126371
FOURCHETTE À DESSERT
DESSERT /SALAD FORK
TENEDOR DE POSTRE
17,7 CM - 6 IN^{5/16}



210732
COUPEAU À DESSERT MONOBLOC LAME UNIE
DESSERT KNIFE SOLID HANDLE
CUCHILLO DE POSTRE HOJA LISA
20,7 CM - 8 IN^{1/8}



189971
COUPEAU À BEURRE MONOBLOC LAME UNIE
BUTTER KNIFE SOLID HANDLE
CUCHILLO DE MANTEQUILLA
HOJA LISA
18,9 CM - 7 IN^{7/16}



126377
FOURCHETTE À POISSON
FISH FORK
TENEDOR DE PESCADO
17,7 CM - 6 IN^{5/16}



181181
COUPEAU À POISSON/ GOURMET
GOURMET FISH KNIFE
CUCHILLO DE PESCADO
20,1 CM - 7 IN^{5/16}



126358
CUILLÈRE À CAFÉ
COFFEE/TEA SPOON
CUCHARA DE CAFÉ
13,7 CM - 5 IN^{3/8}



140852
CUILLÈRE À MOKA
DEMI TASSE SPOON
CUCHARA DE MOKA
11 CM - 4 IN^{5/16}



189973
CUILLÈRE À SODA
ICED TEA SPOON
CUCHARA DE SODA/HELADO
19 CM - 7 IN^{1/2}



126383
FOURCHETTE À GÂTEAUX COCKTAIL
PASTRY/COCKTAIL FORK
TENEDOR DE PASTEL
13,7 CM - 5 IN^{3/8}



189974
FOURCHETTE À HÙÎTRES
OYSTER FORK
TENEDOR DE OSTRAS
14,1 CM - 5 IN^{9/16}



231218
FOURCHETTE DE SERVICE
SERVING FORK
TENEDOR DE SERVICIO/ENSALADA
26,6 CM - 10 IN^{1/2}



231219
CUILLÈRE DE SERVICE
SERVING SPOON
CUCHARA DE SERVICIO/ENSALADA
26,6 CM - 10 IN^{1/2}



231221
PELLE À TARTE MONOBLOC
PASTRY SERVER SOLID HANDLE
PALA PARA TARTA
25,2 CM - 9 IN^{5/16}

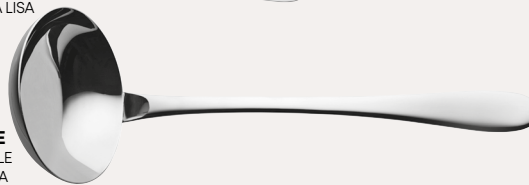

231220
LOUCHE
SOUP LADLE
CAZO
29 CM - 11 IN^{7/16}



Alldaydining

AQUATIC





235927
FOURCHETTE DE TABLE
 TABLE FORK
 TENEDOR DE MESA
 19,9 CM - 7 IN^{3/16}



235930
COUTEAU DE TABLE MONOBLOC LAME SCIE
 TABLE KNIFE SOLID HANDLE SERRATED
 CUCHILLO DE MESA HOJA SIERRA
 23,2 CM - 9 IN^{1/8}



235928
CUILLÈRE DE TABLE
 TABLE/PASTA SPOON
 CUCHARA DE MESA
 19,9 CM - 7 IN^{3/16}



235938
CUILLÈRE À SOUPE ANGLAISE
 BOUILLON SPOON, ROUND
 CUCHARA DE CONSOMÉ
 18,4 CM - 7 IN^{1/4}



235934
CUILLÈRE À DESSERT
 DESSERT/SOUP SPOON, OVAL
 CUCHARA DE POSTRE
 18,4 CM - 7 IN^{1/4}



235933
FOURCHETTE À DESSERT
 DESSERT/SALAD FORK
 TENEDOR DE POSTRE
 18,4 CM - 7 IN^{1/4}



235935
COUTEAU À DESSERT MONOBLOC LAME SCIE
 DESSERT KNIFE SOLID HANDLE SERRATED
 CUCHILLO DE POSTRE HOJA SIERRA
 20,9 CM - 8 IN^{3/16}



235939
COUTEAU À BEURRE MONOBLOC LAME UNIE
 BUTTER KNIFE SOLID HANDLE
 CUCHILLO DE MANTEQUILLA HOJA LISA
 16,5 CM - 6 IN^{1/2}



235929
CUILLÈRE À CAFÉ
 COFFEE/TEA SPOON
 CUCHARA DE CAFÉ
 13,9 CM - 5 IN^{1/2}



235932
CUILLÈRE À MOKA
 DEMI TASSE SPOON
 CUCHARA DE MOKA
 10,9 CM - 4 IN^{5/16}



235937
FOURCHETTE À GÂTEAUX/ COCKTAIL
 PASTRY/COCKTAIL FORK
 TENEDOR DE PASTEL
 14,1 CM - 5 IN^{9/16}



231218
FOURCHETTE DE SERVICE
 SERVING FORK
 TENEDOR DE SERVICIO/ENSALADA
 26,6 CM - 10 IN^{1/2}



231219
CUILLÈRE DE SERVICE
 SERVING SPOON
 CUCHARA DE SERVICIO/ENSALADA
 26,6 CM - 10 IN^{1/2}



231221
PELLE À TARTE MONOBLOC
 PASTRY SERVER SOLID HANDLE
 PALA PARA TARTA
 25,2 CM - 9 IN^{15/16}



231220
LOUCHE
 SOUP LADLE
 CAZO
 29 CM - 11 IN^{7/16}







153188
FOURCHETTE DE TABLE
TABLE FORK
TENEDOR DE MESA
20,7 CM - 8 IN^{5/8}



153196
COUTEAU DE TABLE MONOBLOC LAME SCIE
TABLE KNIFE SOLID HANDLE SERRATED
CUCHILLO DE MESA HOJA SIERRA
23,5 CM - 9 IN^{1/4}



122418
COUTEAU À STEAK MONOBLOC LAME SCIE
STEAK KNIFE SOLID HANDLE SERRATED
CUCHILLO DE STEAK HOJA SIERRA
22,1 CM - 8 IN^{13/16}



153185
CUILLÈRE DE TABLE
TABLE/PASTA SPOON
CUCHARA DE MESA
20,7 CM - 8 IN^{5/8}



184758
CUILLÈRE À SOUPE ANGLAISE
BOUILLON SPOON, ROUND
CUCHARA DE CONSOMÉ
18,3 CM - 7 IN^{3/16}



153209
CUILLÈRE À DESSERT
DESSERT /SOUP SPOON, OVAL
CUCHARA DE POSTRE
18,6 CM - 7 IN^{5/16}



153212
FOURCHETTE À DESSERT
DESSERT /SALAD FORK
TENEDOR DE POSTRE
18,6 CM - 7 IN^{5/16}



153200
COUTEAU À DESSERT MONOBLOC LAME SCIE
DESSERT KNIFE SOLID HANDLE SERRATED
CUCHILLO DE POSTRE HOJA SIERRA
21,1 CM - 8 IN^{5/16}



154612
COUTEAU À BEURRE MONOBLOC LAME UNIE
BUTTER KNIFE SOLID HANDLE
CUCHILLO DE MANTEQUILLA HOJA LISA
19,4 CM - 7 IN^{5/8}



153203
FOURCHETTE À POISSON
FISH FORK
TENEDOR DE PESCADO
18,6 CM - 7 IN^{5/16}



153206
COUTEAU À POISSON/ GOURMET
GOURMET FISH KNIFE
CUCHILLO DE PESCADO
21,1 CM - 8 IN^{5/16}



153191
CUILLÈRE À CAFÉ
COFFEE/TEA SPOON
CUCHARA DE CAFÉ
14,1 CM - 5 IN^{3/16}



154609
CUILLÈRE À MOKA
DEMI TASSE SPOON
CUCHARA DE MOKA
11,1 CM - 4 IN^{3/8}



190018
CUILLÈRE À SODA
ICED TEA SPOON
CUCHARA DE SODA/HELADO
19 CM - 7 IN^{1/2}



197516
FOURCHETTE À GÂTEAUX COCKTAIL
PASTRY/COCKTAIL FORK
TENEDOR DE PASTEL
13,9 CM - 5 IN^{1/2}



190424
FOURCHETTE À HÙITRES
OYSTER FORK
TENEDOR DE OSTRAS
14,1 CM - 5 IN^{3/16}

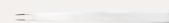

162728
FOURCHETTE/PIQUE À ESCARGOTS/COCKTAIL
COCKTAIL/SNAIL FORK
TENEDOR DE CARACOL/COCKTAIL
10,8 CM - 4 IN^{1/4}

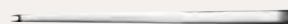

162730
CURETTE À CRUSTACÉS
SEAFOOD SCRAPER
RASQUETA PARA CANGREJO
19,1 CM - 7 IN^{1/2}



197522
FOURCHETTE DE SERVICE
SERVING FORK
TENEDOR DE SERVICIO/ENSALADA
26,6 CM - 10 IN^{1/2}



197523
CUILLÈRE DE SERVICE
SERVING SPOON
CUCHARA DE SERVICIO/ENSALADA
27 CM - 10 IN^{5/8}



197525
SERVICE À SALADE
SALAD SERVING SET
SET SERVICIO DE ENSALADA
30 CM - 11 IN^{13/16}



197527
PELLE À TARTE MONOBLOC
PASTRY SERVER SOLID HANDLE
PALA PARA TARTA
25,1 CM - 9 IN^{7/8}



153193
LOUCHE
SOUP LADLE
CAZO
29,7 CM - 11 IN^{11/16}



154606
LOUCHE À SAUCE
SAUCE LADLE
CAZO PARA SALSA
18,5 CM - 7 IN^{5/16}

Possibilité de personnalisation
Bespoke options available - Posibilidad de personalización



Alldaydining

ASTRÉE MIROIR



DEGRENNE





153998
FOURCHETTE DE TABLE
TABLE FORK
TENEDOR DE MESA
20,7 CM - 8 IN^{5/16}



154002
COUTEAU DE TABLE MONOBLOC LAME SCIE
TABLE KNIFE SOLID HANDLE SERRATED
CUCHILLO DE MESA HOJA SIERRA
23,5 CM - 9 IN^{1/4}



199761
COUTEAU À STEAK MONOBLOC LAME SCIE
STEAK KNIFE SOLID HANDLE SERRATED
CUCHILLO DE STEAK HOJA SIERRA
22,8 CM - 9 IN



153996
CUILLÈRE DE TABLE
TABLE/PASTA SPOON
CUCHARA DE MESA
20,7 CM - 8 IN^{5/16}



190015
CUILLÈRE À SOUPE ANGLAISE
BOUILLON SPOON, ROUND
CUCHARA DE CONSOMÉ
18,3 CM - 7 IN^{3/16}



154571
CUILLÈRE À DESSERT
DESSERT /SOUP SPOON, OVAL
CUCHARA DE POSTRE
18,6 CM - 7 IN^{5/16}



154574
FOURCHETTE À DESSERT
DESSERT /SALAD FORK
TENEDOR DE POSTRE
18,6 CM - 7 IN^{5/16}



154555
COUTEAU À DESSERT MONOBLOC LAME SCIE
DESSERT KNIFE SOLID HANDLE SERRATED
CUCHILLO DE POSTRE HOJASIERRA
21,1 CM - 8 IN^{5/16}



154580
COUTEAU À BEURRE MONOBLOC LAME UNIE
BUTTER KNIFE SOLID HANDLE
CUCHILLO DE MANTEQUILLA HOJA LISA
19,4 CM - 7 IN^{5/8}



154558
FOURCHETTE À POISSON
FISH FORK
TENEDOR DE PESCADO
18,7 CM - 7 IN^{3/8}



154561
COUTEAU À POISSON
FISH KNIFE
CUCHILLO DE PESCADO
21,1 CM - 8 IN^{5/16}



154001
CUILLÈRE À CAFÉ
COFFEE/TEA SPOON
CUCHARA DE CAFÉ
14,1 CM - 5 IN^{3/16}



154577
CUILLÈRE À MOKA
DEMI TASSE SPOON
CUCHARA DE MOKA
11,1 CM - 4 IN^{3/8}



190016
CUILLÈRE À SODA
ICED TEA SPOON
CUCHARA DE SODA/HELADO
19 CM - 7 IN^{1/2}



154547
FOURCHETTE À GÂTEAUX/ COCKTAIL
PASTRY/COCKTAIL FORK
TENEDOR DE PASTEL
14 CM - 5 IN^{1/2}



154563
FOURCHETTE DE SERVICE
SERVING FORK
TENEDOR DE SERVICIO/ENSALADA
25,1 CM - 9 IN^{7/8}



154562
CUILLÈRE DE SERVICE
SERVING SPOON
CUCHARA DE SERVICIO/ENSALADA
25,5 CM - 10 IN^{1/16}



154566
SERVICE À SALADE
SALAD SERVING SET
SET SERVICIO DE ENSALADA
24,3 CM - 9 IN^{3/16}



154552
PELLE À TARTE MONOBLOC
PASTRY SERVER SOLID HANDLE
PALA PARA TARTA
25,3 CM - 9 IN^{5/16}



154550
LOUCHE
SOUP LADLE
CAZO
29,7 CM - 11 IN^{11/16}

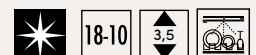

Alldaydining

ASTRÉE CISELÉ





226167
FOURCHETTE DE TABLE
TABLE FORK
TENEDOR DE MESA
21 CM - 8 IN^{1/4}



226177
COUTEAU DE TABLE MONOBLOC LAME SCIE N°1
TABLE KNIFE SOLID HANDLE SERRATED N°1
CUCHILLO DE MESA HOJA SIERRA N°1
22,8 CM - 9 IN



226176
COUTEAU À STEAK MONOBLOC LAME SCIE N°2
STEAK KNIFE SOLID HANDLE SERRATED N°2
CUCHILLO DE STEAK HOJA SIERRA N°2
22,8 CM - 9 IN



226168
CUILLÈRE DE TABLE
TABLE/PASTA SPOON
CUCHARA DE MESA
21 CM - 8 IN^{1/4}



226172
CUILLÈRE À DESSERT
DESSERT /SOUP SPOON, OVAL
CUCHARA DE POSTRE
18,9 CM - 7 IN^{7/16}



226171
FOURCHETTE À DESSERT
DESSERT /SALAD FORK
TENEDOR DE POSTRE
18,9 CM - 7 IN^{7/16}



226179
COUTEAU À DESSERT MONOBLOC LAME UNIE N°1
DESSERT KNIFE SOLID HANDLE N°1
CUCHILLO DE POSTRE HOJA LISA N°1
20,5 CM - 8 IN^{1/16}



226178
COUTEAU À DESSERT MONOBLOC LAME UNIE N°2
DESSERT KNIFE SOLID HANDLE N°2
CUCHILLO DE POSTRE HOJA LISA N°2
20,5 CM - 8 IN^{1/16}



226171
FOURCHETTE À POISSON
FISH FORK
TENEDOR DE PESCADO
18,9 CM - 7 IN^{7/16}



226173
COUTEAU À POISSON/ GOURMET
GOURMET FISH KNIFE
CUCHILLO DE PESCADO
21 CM - 8 IN^{1/4}



226169
CUILLÈRE À CAFÉ
COFFEE/TEA SPOON
CUCHARA DE CAFÉ
14,5 CM - 5 IN^{11/16}



226170
CUILLÈRE À MOKA
DEMI TASSE SPOON
CUCHARA DE MOKA
11,6 CM - 4 IN^{9/16}

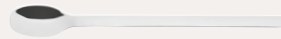

226175
CUILLÈRE À SODA
ICED TEA SPOON
CUCHARA DE SODA/HELADO
19 CM - 7 IN^{1/2}



226174
FOURCHETTE À GÂTEAUX/ COCKTAIL
PASTRY/COCKTAIL FORK
TENEDOR DE PASTEL
14,5 CM - 5 IN^{11/16}



190424
FOURCHETTE À HUITRES
OYSTER FORK
TENEDOR DE OSTRAS
14,1 CM - 5 IN^{5/16}



197522
FOURCHETTE DE SERVICE
SERVING FORK
TENEDOR DE SERVICIO/ENSALADA
26,6 CM - 10 IN^{1/2}



197523
CUILLÈRE DE SERVICE
SERVING SPOON
CUCHARA DE SERVICIO/ENSALADA
27 CM - 10 IN^{5/8}



197525
SERVICE À SALADE
SALAD SERVING SET
SET SERVICIO DE ENSALADA
30 CM - 11 IN^{13/16}



197527
PELLE À TARTE MONOBLOC
PASTRY SERVER SOLID HANDLE
PALA PARA TARTA
25,1 CM - 9 IN^{7/8}



153193
LOUCHE
SOUP LADLE
CAZO
29,7 CM - 11 IN^{11/16}



154606
LOUCHE À SAUCE
SAUCE LADLE
CAZO PARA SALSAS
18,5 CM - 7 IN^{5/16}



MIRAGE





163580
FOURCHETTE DE TABLE
TABLE FORK
TENEDOR DE MESA
20,9 CM - 8 IN^{5/16}



189969
COUTEAU DE TABLE MONOBLOC LAME SCIE
TABLE KNIFE SOLID HANDLE SERRATED
CUCHILLO DE MESA HOJA SIERRA
22,9 CM - 9 IN



207189
COUTEAU À STEAK MONOBLOC LAME SCIE
STEAK KNIFE SOLID HANDLE SERRATED
CUCHILLO DE STEAK HOJA SIERRA
23,6 CM - 9 IN^{5/16}



163579
CUILLÈRE DE TABLE
TABLE/PASTA SPOON
CUCHARA DE MESA
21,1 CM - 8 IN^{5/16}



164713
CUILLÈRE À DESSERT
DESSERT /SOUP SPOON, OVAL
CUCHARA DE POSTRE
19 CM - 7 IN^{1/2}



164714
FOURCHETTE À DESSERT
DESSERT /SALAD FORK
TENEDOR DE POSTRE
18,9 CM - 7 IN^{7/16}



210627
COUTEAU À DESSERT MONOBLOC LAME SCIE
DESSERT KNIFE SOLID HANDLE SERRATED
CUCHILLO DE POSTRE HOJA SIERRA
20,6 CM - 8 IN^{1/8}



189971
COUTEAU À BEURRE MONOBLOC LAME UNIE
BUTTER KNIFE SOLID HANDLE
CUCHILLO DE MANTEQUILLA HOJA LISA
18,8 CM - 7 IN^{3/8}



164708
FOURCHETTE À POISSON
FISH FORK
TENEDOR DE PESCADO
18,9 CM - 7 IN^{7/16}



164709
COUTEAU À POISSON/ GOURMET
GOURMET FISH KNIFE
CUCHILLO DE PESCADO
21 CM - 8 IN^{1/4}



163581
CUILLÈRE À CAFÉ
COFFEE/TEA SPOON
CUCHARA DE CAFÉ
14,3 CM - 5 IN^{5/8}



164715
CUILLÈRE À MOKA/TOUILLETTE
DEMI TASSE SPOON
CUCHARA DE MOKA
11 CM - 4 IN^{5/16}



189973
CUILLÈRE À SODA
ICED TEA SPOON
CUCHARA DE SODA/HELADO
19 CM - 7 IN^{1/2}



164705
FOURCHETTE À GÂTEAUX/ COCKTAIL
PASTRY/COCKTAIL FORK
TENEDOR DE PASTEL
14,4 CM - 5 IN^{17/16}



189974
FOURCHETTE À HUITRES
OYSTER FORK
TENEDOR DE OSTRAS
14,1 CM - 5 IN^{3/16}

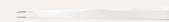

162728
FOURCHETTE/PIQUE À ESCARGOTS/COCKTAIL
COCKTAIL/SNAIL FORK
TENEDOR DE CARACOL/COCKTAIL
10,8 CM - 4 IN^{1/4}



162730
CREUETTE À CRUSTACÉS
SEAFOOD SCRAPER
RASQUETA PARA CANGREJO
19,1 CM - 7 IN^{1/2}



231218
FOURCHETTE DE SERVICE
SERVING FORK
TENEDOR DE SERVICIO/ENSALADA
26,6 CM - 10 IN^{1/2}



231219
CUILLÈRE DE SERVICE
SERVING SPOON
CUCHARA DE SERVICIO/ENSALADA
26,6 CM - 10 IN^{1/2}



231221
PELLE À TARTE MONOBLOC
PASTRY SERVER SOLID HANDLE
PALA PARA TARTA
25,2 CM - 9 IN^{15/16}



231220
LOUCHE
SOUP LADLE
CAZO
29 CM - 11 IN^{7/16}

Possibilité de personnalisation
Bespoke options available - Posibilidad de personalización



ALO A





111894
FOURCHETTE DE TABLE
 TABLE FORK
 TENEDOR DE MESA
 20,4 CM - 8 IN^{1/16}



111921
**COUTEAU DE TABLE
 MONOBLOC LAME SCIE**
 TABLE KNIFE SOLID HANDLE SERRATED
 CUCHILLO DE MESA HOJA SIERRA
 23 CM - 9 IN^{1/16}



111891
CUILLÈRE DE TABLE
 TABLE/PASTA SPOON
 CUCHARA DE MESA
 20,4 CM - 8 IN^{1/16}



111904
CUILLÈRE À DESSERT
 DESSERT/SOUP SPOON, OVAL
 CUCHARA DE POSTRE
 18 CM - 7 IN^{1/16}



111907
FOURCHETTE À DESSERT
 DESSERT/SALAD FORK
 TENEDOR DE POSTRE
 18 CM - 7 IN^{1/16}



210631
**COUTEAU À DESSERT
 MONOBLOC LAME SCIE**
 DESSERT KNIFE SOLID HANDLE
 SERRATED
 CUCHILLO DE POSTRE HOJA SIERRA
 20,3 CM - 8 IN



111897
CUILLÈRE À CAFÉ
 COFFEE/TEA SPOON
 CUCHARA DE CAFÉ
 13,6 CM - 5 IN^{3/8}



114437
CUILLÈRE À MOKA
 DEMI TASSE SPOON
 CUCHARA DE MOKA
 11 CM - 4 IN^{5/16}



©Patrick ROUGEREAU - Photo non contractuelle

Possibilité de personnalisation
 Bespoke options available - Posibilidad de personalización



NORWAY



NEW AZUR - GREEN - VERDE



238531
FOURCHETTE DE TABLE
TABLE FORK
TENEDOR DE MESA
21,6 CM - 8 IN^{1/2}



238536
**COUPEAU DE TABLE
STEAK LAME SCIE**
STEAK/TABLE KNIFE SERRATED
CUCHILLO DE STEAK HOJA SIERRA
23 CM - 9 IN^{1/16}



238533
CUILLÈRE DE TABLE
TABLE/PASTA SPOON
CUCHARA DE MESA
21,8 CM - 8 IN^{9/16}



238535
CUILLÈRE À CAFÉ
COFFEE/TEA SPOON
CUCHARA DE CAFÉ
15,2 CM - 6 IN

NEW ORCHIDEE - PURPLE - MORADO



238530
FOURCHETTE DE TABLE
TABLE FORK
TENEDOR DE MESA
21,6 CM - 8 IN^{1/2}



238537
**COUPEAU DE TABLE
STEAK LAME SCIE**
STEAK/TABLE KNIFE SERRATED
CUCHILLO DE STEAK HOJA SIERRA
23 CM - 9 IN^{1/16}



238532
CUILLÈRE DE TABLE
TABLE/PASTA SPOON
CUCHARA DE MESA
21,8 CM - 8 IN^{9/16}



238534
CUILLÈRE À CAFÉ
COFFEE/TEA SPOON
CUCHARA DE CAFÉ
15,2 CM - 6 IN

CARBONE - CARBON - CARBONO



205883
FOURCHETTE DE TABLE
TABLE FORK
TENEDOR DE MESA
21,6 CM - 8 IN^{1/2}



205885
**COUPEAU DE TABLE
STEAK LAME SCIE**
STEAK/TABLE KNIFE SERRATED
CUCHILLO DE STEAK HOJA SIERRA
23 CM - 9 IN^{1/16}



205884
CUILLÈRE DE TABLE
TABLE/PASTA SPOON
CUCHARA DE MESA
21,8 CM - 8 IN^{9/16}



205886
CUILLÈRE À CAFÉ
COFFEE/TEA SPOON
CUCHARA DE CAFÉ
15,2 CM - 6 IN

ROUGE - RED - ROJO



206782
FOURCHETTE DE TABLE
TABLE FORK
TENEDOR DE MESA
21,6 CM - 8 IN^{1/2}



205894
**COUPEAU DE TABLE
STEAK LAME SCIE**
STEAK/TABLE KNIFE SERRATED
CUCHILLO DE STEAK HOJA SIERRA
23 CM - 9 IN^{1/16}



206783
CUILLÈRE DE TABLE
TABLE/PASTA SPOON
CUCHARA DE MESA
21,8 CM - 8 IN^{9/16}



206784
CUILLÈRE À CAFÉ
COFFEE/TEA SPOON
CUCHARA DE CAFÉ
15,2 CM - 6 IN

BLEU MARIN - STEEL BLUE - AZUL MARINO



226772
FOURCHETTE DE TABLE
TABLE FORK
TENEDOR DE MESA
21,6 CM - 8 IN^{1/2}



226774
**COUPEAU DE TABLE
STEAK LAME SCIE**
STEAK/TABLE KNIFE SERRATED
CUCHILLO DE STEAK HOJA SIERRA
23 CM - 9 IN^{1/16}



226773
CUILLÈRE DE TABLE
TABLE/PASTA SPOON
CUCHARA DE MESA
21,8 CM - 8 IN^{9/16}



226775
CUILLÈRE À CAFÉ
COFFEE/TEA SPOON
CUCHARA DE CAFÉ
15,2 CM - 6 IN

CÈPE - TAUPE - TOPO



226787
FOURCHETTE DE TABLE
TABLE FORK
TENEDOR DE MESA
21,6 CM - 8 IN^{1/2}



226789
**COUPEAU DE TABLE
STEAK LAME SCIE**
STEAK/TABLE KNIFE SERRATED
CUCHILLO DE STEAK HOJA SIERRA
23 CM - 9 IN^{1/16}



226788
CUILLÈRE DE TABLE
TABLE/PASTA SPOON
CUCHARA DE MESA
21,8 CM - 8 IN^{9/16}



226790
CUILLÈRE À CAFÉ
COFFEE/TEA SPOON
CUCHARA DE CAFÉ
15,2 CM - 6 IN



Visuel non contractuel

Alldaydining

QUARTZ







COLLECTIONS CLASSIQUES

NORMANDY

232963 - FOURCHETTE DE TABLE - TABLE FORK - TENEDOR DE MESA

232966 - COUTEAU DE TABLE MONOBLOC LAME SCIE - TABLE KNIFE SOLID HANDLE
SERRATED - CUCHILLO DE MESA HOJA SIERRA

232964 - CUIILLÈRE DE TABLE - TABLE SPOON - CUCHARA DE MESA

232965 - CUIILLÈRE À CAFÉ - COFFEE/TEA SPOON - CUCHARA DE CAFÉ

P. 142-143





126556
FOURCHETTE DE TABLE
TABLE FORK
TENEDOR DE MESA
20,2 CM - 7 IN^{15/16}



126559
CUILLÈRE À CAFÉ
COFFEE/TEA SPOON
CUCHARA DE CAFÉ
13,9 CM - 5 IN^{1/2}



126565
COUPEAU DE TABLE
MANCHE ORFÈVRE LAME UNIE
TABLE KNIFE HOLLOW HANDLE
CUCHILLO DE MESA ENMANGADO
HOJA LISA
23 CM - 9 IN^{1/16}



155452
CUILLÈRE À MOKA
DEMI TASSE SPOON
CUCHARA DE MOKA
11,1 CM - 4 IN^{3/8}



130332
COUPEAU DE TABLE
MANCHE ORFÈVRE LAME SCIE
TABLE KNIFE HOLLOW HANDLE SERRATED
CUCHILLO DE MESA ENMANGADO
HOJA SIERRA
23 CM - 9 IN^{1/16}



126591
FOURCHETTE DE SERVICE
SERVING FORK
TENEDOR DE SERVICIO/ENSALADA
24,8 CM - 9 IN^{3/4}



126553
CUILLÈRE DE TABLE
TABLE/PASTA SPOON
CUCHARA DE MESA
20,5 CM - 8 IN^{1/16}



126589
CUILLÈRE DE SERVICE
SERVING SPOON
CUCHARA DE SERVICIO/ENSALADA
25 CM - 9 IN^{3/16}



126569
CUILLÈRE À DESSERT
DESSERT/SOUP SPOON, OVAL
CUCHARA DE POSTRE
18 CM - 7 IN^{1/16}



126587
PELLE À TARTE
MANCHE ORFÈVRE
PASTRY SERVER HOLLOW HANDLE
PALA PARA TARTA ENMANGADO
24 CM - 9 IN^{7/16}



126572
FOURCHETTE À DESSERT
DESSERT/SALAD FORK
TENEDOR DE POSTRE
18 CM - 7 IN^{1/16}



126595
LOUCHE À SAUCE
SAUCE LADLE
CAZO PARA SALSA
17 CM - 6 IN^{11/16}



126575
COUPEAU À DESSERT
MANCHE ORFÈVRE LAME UNIE
DESSERT KNIFE HOLLOW HANDLE
CUCHILLO DE POSTRE ENMANGADO HOJA LISA
20,5 CM - 8 IN^{1/16}



154828
COUPEAU À BEURRE
MANCHE ORFÈVRE LAME UNIE
BUTTER KNIFE HOLLOW HANDLE
CUCHILLO DE MANTEQUILLA
ENMANGADO HOJA LISA
18,8 CM - 7 IN^{3/8}



126578
FOURCHETTE À POISSON
FISH FORK
TENEDOR DE PESCADO
18 CM - 7 IN^{1/16}



126581
COUPEAU À POISSON
FISH KNIFE
CUCHILLO DE PESCADO
20,1 CM - 7 IN^{5/16}

Possibilité de personnalisation
Bespoke options available - Posibilidad de personalización



Vintage Line

ABSOLU

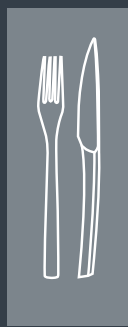



232963
FOURCHETTE DE TABLE
 TABLE FORK
 TENEDOR DE MESA
 20,3 CM - 8 IN



232966
COUTEAU DE TABLE MONOBLOC LAME SCIE
 TABLE KNIFE SOLID HANDLE SERRATED
 CUCHILLO DE MESA HOJA SIERRA
 24 CM - 9 IN^{7/16}

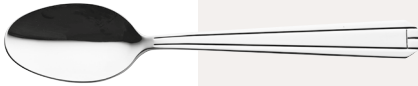

232964
CUILLÈRE DE TABLE
 TABLE/PASTA SPOON
 CUCHARA DE MESA
 20,3 CM - 8 IN



234654
CUILLÈRE À SOUPE ANGLAISE
 BOUILLON SPOON
 CUCHARA DE CONSOMÉ
 17,6 CM - 6 IN^{5/16}



234659
CUILLÈRE À DESSERT
 DESSERT /SOUP SPOON, OVAL
 CUCHARA DE POSTRE
 18,2 CM - 7 IN^{3/16}

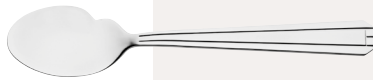

234655
CUILLÈRE GOURMET
 GOURMET SPOON
 CUCHARA GOURMET
 18,2 CM - 7 IN^{3/16}



234656
FOURCHETTE À DESSERT
 DESSERT/SALAD FORK
 TENEDOR DE POSTRE
 18,3 CM - 7 IN^{3/16}



234657
COUTEAU À DESSERT MONOBLOC LAME UNIE
 DESSERT KNIFE SOLID HANDLE
 CUCHILLO DE POSTRE
 21,5 CM - 8 IN^{7/16}



234658
COUTEAU À BEURRE MONOBLOC LAME UNIE
 BUTTER KNIFE SOLID HANDLE
 CUCHILLO DE MANTEQUILLA
 HOJA LISA
 18,5 CM - 7 IN^{5/16}



232965
CUILLÈRE À CAFÉ
 COFFEE/TEA SPOON
 CUCHARA DE CAFÉ
 14 CM - 5 IN^{1/2}



234660
CUILLÈRE À MOKA
 DEMI TASSE SPOON
 CUCHARA DE MOKA
 11,1 CM - 4 IN^{3/8}



234661
FOURCHETTE À GÂTEAUX/COCKTAIL
 PASTRY/COCKTAIL FORK
 TENEDOR DE PASTEL
 14 CM - 5 IN^{1/2}

Possibilité de personnalisation
 Bespoke options available - Posibilidad de personalización



NORMANDY





205533
FOURCHETTE DE TABLE
TABLE FORK
TENEDOR DE MESA
20,7 CM - 8 IN^{3/16}



205538
FOURCHETTE À POISSON
FISH FORK
TENEDOR DE PESCADO
18,2 CM - 7 IN^{3/16}



199160
**COUTEAU DE TABLE
MANCHE ORFÈVRE LAME SCIE**
TABLE KNIFE HOLLOW HANDLE SERRATED
CUCHILLO DE MESA ENMANGADO
HOJA SIERRA
23,3 CM - 9 IN^{3/16}



205537
COUTEAU À POISSON
FISH KNIFE
CUCHILLO DE PESCADO
21,2 CM - 8 IN^{3/8}



215601
**COUTEAU DE TABLE
MANCHE ORFÈVRE
LAME SCIE RONDE**
TABLE KNIFE HOLLOW HANDLE SERRATED
ROUNDED BLADE
CUCHILLO DE MESA ENMANGADO
REDONDA HOJA SIERRA
23,3 CM - 9 IN^{3/16}



199159
CUILLÈRE À CAFÉ
COFFEE/TEA SPOON
CUCHARA DE CAFÉ
14,1 CM - 5 IN^{3/16}



205534
CUILLÈRE DE TABLE
TABLE/PASTA SPOON
CUCHARA DE MESA
20,7 CM - 8 IN^{1/8}



199161
CUILLÈRE À MOKA
DEMI TASSE SPOON
CUCHARA DE MOKA
11,2 CM - 4 IN^{7/16}



205535
CUILLÈRE À SOUPE ANGLAISE
BOUILLON SPOON, ROUND
CUCHARA DE CONSOMÉ
17,7 CM - 6 IN^{5/16}



199169
CUILLÈRE À SODA
ICED TEA SPOON
CUCHARA DE SODA/HELADO
18,8 CM - 7 IN^{3/8}



205539
CUILLÈRE À DESSERT
DESSERT/SOUP SPOON, OVAL
CUCHARA DE POSTRE
18,2 CM - 7 IN^{3/16}



199167
FOURCHETTE À GÂTEAUX/COCKTAIL
PASTRY/COCKTAIL FORK
TENEDOR DE PASTEL
14,2 CM - 5 IN^{3/16}



205538
FOURCHETTE À DESSERT
DESSERT/SALAD FORK
TENEDOR DE POSTRE
18,2 CM - 7 IN^{3/16}



199172
FOURCHETTE DE SERVICE
SERVING FORK
TENEDOR DE SERVICIO/ENSALADA
25 CM - 9 IN^{13/16}



199164
**COUTEAU À DESSERT
MANCHE ORFÈVRE LAME UNIE**
DESSERT KNIFE HOLLOW HANDLE
CUCHILLO DE POSTRE ENMANGADO
HOJA LISA
20,6 CM - 8 IN^{1/8}



199171
CUILLÈRE DE SERVICE
SERVING SPOON
CUCHARA DE SERVICIO/ENSALADA
25 CM - 9 IN^{13/16}



215602
**COUTEAU À DESSERT
MANCHE ORFÈVRE
LAME UNIE RONDE**
DESSERT KNIFE HOLLOW
HANDLE ROUNDED BLADE
CUCHILLO DE POSTRE
ENMANGADO
REDONDA HOJA LISA
20,6 CM - 8 IN^{1/8}



199174
LOUCHE
SOUP LADLE
CAZO
30,2 CM - 11 IN^{7/8}



199170
**COUTEAU À BEURRE
MANCHE ORFÈVRE LAME UNIE**
BUTTER KNIFE HOLLOW HANDLE
CUCHILLO DE MANTEQUILLA
ENMANGADO HOJA LISA
18,5 CM - 7 IN^{5/16}



199173
**PELLE À TARTE
MONOBLOC**
PASTRY SERVER SOLID HANDLE
PALA PARA TARTA
23,9 CM - 9 IN^{7/16}

Possibilité de personnalisation
Bespoke options available - Posibilidad de personalización



SQUADRO





126077
FOURCHETTE DE TABLE
TABLE FORK
TENEDOR DE MESA
20,8 CM - 8 IN^{3/16}



190643
**COUTEAU DE TABLE
MONOBLOC LOURD
MANCHE DROIT LAME SCIE**
TABLE KNIFE HEAVY SOLID HANDLE SERRATED
CUCHILLO DE MESA PESADO
RECTO MANGO HOJA SIERRA
24,6 CM - 9 IN^{11/16}



130140
**COUTEAU DE TABLE
MANCHE ORFÈVRE DROIT LAME SCIE**
TABLE KNIFE HOLLOW HANDLE SERRATED
CUCHILLO DE MESA ENMANGADO
RECTO MANGO HOJA SIERRA
24,6 CM - 9 IN^{11/16}



127654
**COUTEAU À STEAK
MANCHE ORFÈVRE DROIT LAME SCIE**
STEAK KNIFE HOLLOW HANDLE SERRATED
CUCHILLO DE STEAK ENMANGADO
HOJA SIERRA
23,9 CM - 9 IN^{7/16}



126074
CUILLÈRE DE TABLE
TABLE/PASTA SPOON
CUCHARA DE MESA
20,8 CM - 8 IN^{3/16}



127651
CUILLÈRE À SOUPE ANGLAISE
BOUILLON SPOON, ROUND
CUCHARA DE CONSOMÉ
17,4 CM - 6 IN^{7/8}



126090
CUILLÈRE À DESSERT
DESSERT/SOUP SPOON, OVAL
CUCHARA DE POSTRE
18 CM - 7 IN^{1/16}



126093
FOURCHETTE À DESSERT
DESSERT/SALAD FORK
TENEDOR DE POSTRE
17,8 CM - 7 IN



190644
**COUTEAU À DESSERT
MONOBLOC LOURD MANCHE
DROIT LAME SCIE**
DESSERT KNIFE HEAVY SOLID HANDLE
SERRATED
CUCHILLO DE POSTRE PESADO
RECTO MANGO HOJA SIERRA
20,5 CM - 8 IN^{1/16}



126096
**COUTEAU À DESSERT
MANCHE ORFÈVRE LAME UNIE**
DESSERT KNIFE HOLLOW HANDLE
CUCHILLO DE POSTRE RECTO MANGO
ENMANGADO HOJA LISA
20,5 CM - 8 IN^{1/16}



190417
**COUTEAU À BEURRE
MONOBLOC LOURD MANCHE
DROIT LAME UNIE**
BUTTER KNIFE HEAVY SOLID HANDLE
CUCHILLO DE MANTEQUILLA
PESADO RECTO MANGO HOJA LISA
18,7 CM - 7 IN^{3/8}



129344
**COUTEAU À BEURRE
MANCHE DROIT LAME UNIE**
BUTTER KNIFE SOLID HANDLE
CUCHILLO DE MANTEQUILLA
ENMANGADO HOJA LISA
18,7 CM - 7 IN^{3/8}



126099
FOURCHETTE À POISSON
FISH FORK
TENEDOR DE PESCADO
17,7 CM - 6 IN^{15/16}



126102
COUTEAU À POISSON
FISH KNIFE
CUCHILLO DE PESCADO
19,9 CM - 7 IN^{13/16}



129958
CUILLÈRE À SAUCE GOURMET
GOURMET/SAUCE SPOON
CUCHARA PARA SALSA
17,9 CM - 7 IN^{1/16}



126080
CUILLÈRE À CAFÉ
COFFEE/TEA SPOON
CUCHARA DE CAFÉ
14 CM - 5 IN^{1/2}



126105
CUILLÈRE À MOKA
DEMI TASSE SPOON
CUCHARA DE MOKA
11 CM - 4 IN^{5/16}



130146
CUILLÈRE À SODA
ICED TEA SPOON
CUCHARA DE SODA/HELADO
18,2 CM - 7 IN^{3/16}



126108
FOURCHETTE À GÂTEAUX/COCKTAIL
PASTRY/COCKTAIL FORK
TENEDOR DE PASTEL
13,8 CM - 5 IN^{7/16}



190418
FOURCHETTE À HÙITRES
OYSTER FORK
TENEDOR DE OSTRAS
13 CM - 5 IN^{1/8}

PIÈCES DE SERVICE
SERVING PIECES
SET SERVICIO

VERLAINE
P 156-157

Possibilité de personnalisation
Bespoke options available - Posibilidad de personalización



Vintage Line

FLORENCIA



DEGRÈNE





182968
FOURCHETTE DE TABLE
TABLE FORK
TENEDOR DE MESA
20,8 CM - 8 IN^{3/16}



182970
**COUPEAU DE TABLE
MANCHE ORFÈVRE LAME SCIE**
TABLE KNIFE HOLLOW HANDLE SERRATED
CUCHILLO DE MESA ENMANGADO
HOJA SIERRA
24,6 CM - 9 IN^{11/16}



186278
**COUPEAU À STEAK
MANCHE ORFÈVRE LAME SCIE**
STEAK KNIFE HOLLOW HANDLE SERRATED
CUCHILLO DE STEAK ENMANGADO
HOJA SIERRA
23,9 CM - 9 IN^{7/16}



182967
CUILLÈRE DE TABLE
TABLE/PASTA SPOON
CUCHARA DE MESA
20,8 CM - 8 IN^{3/16}



186276
CUILLÈRE À SOUPE ANGLAISE
BOUILLON SPOON, ROUND
CUCHARA DE CONSOMÉ
17,4 CM - 6 IN^{7/8}



182974
CUILLÈRE À DESSERT
DESSERT/SOUP SPOON, OVAL
CUCHARA DE POSTRE
18 CM - 7 IN^{1/16}



182975
FOURCHETTE À DESSERT
DESSERT/SALAD FORK
TENEDOR DE POSTRE
17,8 CM - 7 IN



182971
**COUPEAU À DESSERT
MANCHE ORFÈVRE LAME UNIE**
DESSERT KNIFE HOLLOW HANDLE
CUCHILLO DE POSTRE ENMANGADO
HOJA LISA
20,5 CM - 8 IN^{1/16}



186279
**COUPEAU À BEURRE
MANCHE ORFÈVRE LAME UNIE**
BUTTER KNIFE HOLLOW HANDLE
CUCHILLO DE MANTEQUILLA
ENMANGADO HOJA LISA
18,7 CM - 7 IN^{3/8}



182972
FOURCHETTE À POISSON
FISH FORK
TENEDOR DE PESCADO
17,7 CM - 6 IN^{15/16}



182973
COUPEAU À POISSON
FISH KNIFE
CUCHILLO DE PESCADO
19,9 CM - 7 IN^{13/16}



186277
CUILLÈRE À SAUCE GOURMET
GOURMET/SAUCE SPOON
CUCHARA PARA SALSA
17,9 CM - 7 IN^{1/16}



182969
CUILLÈRE À CAFÉ
COFFEE/TEA SPOON
CUCHARA DE CAFÉ
14 CM - 5 IN^{1/2}



182976
CUILLÈRE À MOKA
DEMI TASSE SPOON
CUCHARA DE MOKA
11 CM - 4 IN^{5/16}



186275
CUILLÈRE À SODA
ICED TEA SPOON
CUCHARA DE SODA/HELADO
18,2 CM - 7 IN^{3/16}



186274
**FOURCHETTE À GÂTEAUX/
COCKTAIL**
PASTRY/COCKTAIL FORK
TENEDOR DE PASTEL
13,8 CM - 5 IN^{7/16}



190681
FOURCHETTE À HÙÎTRES
OYSTER FORK
TENEDOR DE OSTRAS
13 CM - 5 IN^{1/8}



183803
FOURCHETTE DE SERVICE
SERVING FORK
TENEDOR DE SERVICIO/ENSALADA
24,8 CM - 9 IN^{3/4}



183802
CUILLÈRE DE SERVICE
SERVING SPOON
CUCHARA DE SERVICIO/ENSALADA
25 CM - 9 IN^{13/16}



Vintage Line

MARQUISE

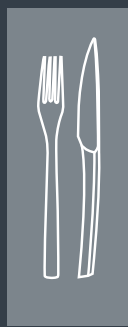



127442
FOURCHETTE DE TABLE
TABLE FORK
TENEDOR DE MESA
20,8 CM - 8 IN^{3/16}



226578
COUTEAU DE TABLE MONOBLOC LOURD LAME SCIE
TABLE KNIFE HEAVY SOLID HANDLE SERRATED
CUCHILLO DE MESA PESADO
HOJA SIERRA
24,6 CM - 9 IN^{11/16}



139158
COUTEAU DE TABLE MANCHE ORFÈVRE LAME SCIE
TABLE KNIFE HOLLOW HANDLE SERRATED
CUCHILLO DE MESA ENMANGADO
HOJA SIERRA
24,6 CM - 9 IN^{11/16}



128841
COUTEAU À STEAK MANCHE ORFÈVRE LAME SCIE
STEAK KNIFE HOLLOW HANDLE SERRATED
CUCHILLO DE STEAK ENMANGADO
HOJA SIERRA
23,9 CM - 9 IN^{7/16}



127439
CUILLÈRE DE TABLE
TABLE/PASTA SPOON
CUCHARA DE MESA
20,8 CM - 8 IN^{3/16}



130273
CUILLÈRE À SOUPE ANGLAISE
BOUILLON SPOON, ROUND
CUCHARA DE CONSOMÉ
17,4 CM - 6 IN^{7/8}



127464
CUILLÈRE À DESSERT
DESSERT/SOUP SPOON, OVAL
CUCHARA DE POSTRE
18 CM - 7 IN^{1/16}



127467
FOURCHETTE À DESSERT
DESSERT/SALAD FORK
TENEDOR DE POSTRE
17,8 CM - 7 IN



226579
COUTEAU À DESSERT MONOBLOC LOURD LAME UNIE
DESSERT KNIFE HEAVY SOLID HANDLE
CUCHILLO DE POSTRE PESADO
HOJA LISA
21,1 CM - 8 IN^{5/16}



127470
COUTEAU À DESSERT MANCHE ORFÈVRE LAME UNIE
DESSERT KNIFE HOLLOW HANDLE
CUCHILLO DE POSTRE ENMANGADO
HOJA LISA
20,5 CM - 8 IN^{1/16}



226580
COUTEAU À BEURRE MONOBLOC LOURD LAME UNIE
BUTTER KNIFE HEAVY SOLID HANDLE
CUCHILLO DE MANTEQUILLA
PESADO HOJA LISA
19 CM - 7 IN^{1/2}



122769
COUTEAU À BEURRE MANCHE ORFÈVRE LAME UNIE
BUTTER KNIFE HOLLOW HANDLE
CUCHILLO DE MANTEQUILLA
ENMANGADO HOJA LISA
18,7 CM - 7 IN^{3/8}



127473
FOURCHETTE À POISSON
FISH FORK
TENEDOR DE PESCADO
17,7 CM - 6 IN^{15/16}



127477
COUTEAU À POISSON
FISH KNIFE
CUCHILLO DE PESCADO
19,9 CM - 7 IN^{13/16}



130542
CUILLÈRE À SAUCE GOURMET
GOURMET/SAUCE SPOON
CUCHARA PARA SALSA
17,9 CM - 7 IN^{1/16}



127455
CUILLÈRE À CAFÉ
COFFEE/TEA SPOON
CUCHARA DE CAFÉ
14 CM - 5 IN^{1/2}



127479
CUILLÈRE À MOKA
DEMI TASSE SPOON
CUCHARA DE MOKA
11 CM - 4 IN^{5/16}



127482
FOURCHETTE À GÂTEAUX/ COCKTAIL
PASTRY/COCKTAIL FORK
TENEDOR DE PASTEL
13,8 CM - 5 IN^{7/16}



130266
FOURCHETTE À HÛÎTRES
OYSTER FORK
TENEDOR DE OSTRAS
13 CM - 5 IN^{1/8}

PIÈCES DE SERVICE
SERVING PIECES
SET SERVICIO

VELLAINE
P 156-157



MILADY



DEGRÈNE



105278
FOURCHETTE DE TABLE
 TABLE FORK
 TENEDOR DE MESA
 20,8 CM - 8 IN^{3/16}



105274
**COUTEAU DE TABLE
 MANCHE ORFÈVRE LAME SCIE**
 TABLE KNIFE HOLLOW HANDLE SERRATED
 CUCHILLO DE MESA ENMANGADO
 HOJA SIERRA
 24,6 CM - 9 IN^{11/16}



105310
CUILLÈRE DE TABLE
 TABLE/PASTA SPOON
 CUCHARA DE MESA
 20,8 CM - 8 IN^{3/16}



105294
CUILLÈRE À DESSERT
 DESSERT/SOUP SPOON, OVAL
 CUCHARA DE POSTRE
 18 CM - 7 IN^{1/16}



105290
FOURCHETTE À DESSERT
 DESSERT/SALAD FORK
 TENEDOR DE POSTRE
 17,8 CM - 7 IN



105305
**COUTEAU À DESSERT
 MANCHE ORFÈVRE LAME UNIE**
 DESSERT KNIFE HOLLOW HANDLE
 CUCHILLO DE POSTRE ENMANGADO
 HOJA LISA
 20,5 CM - 8 IN^{1/16}



105303
CUILLÈRE À CAFÉ
 COFFEE/TEA SPOON
 CUCHARA DE CAFÉ
 14 CM - 5 IN^{1/2}



105293
CUILLÈRE À MOKA
 DEMI TASSE SPOON
 CUCHARA DE MOKA
 11 CM - 4 IN^{5/16}



L'alcool est dangereux pour la santé
 Degree promotes responsible drinking and discourages alcohol misuse
 El abuso de alcohol es peligroso para la salud

@Patrick ROUGEREAU

Possibilité de personnalisation
 Bespoke options available - Posibilidad de personalización



Vintage Line

NEUILLY





105831
FOURCHETTE DE TABLE
TABLE FORK
TENEDOR DE MESA
20,8 CM - 8 IN^{3/16}



182460
COUTEAU DE TABLE MONOBLOC LOURD LAME SCIE
TABLE KNIFE HEAVY SOLID HANDLE
SERRATED
CUCHILLO DE MESA PESADO
HOJA SIERRA
24,6 CM - 9 IN^{11/16}



105886
COUTEAU DE TABLE MANCHE ORFÈVRE DROIT LAME UNIE
TABLE KNIFE HOLLOW HANDLE
CUCHILLO DE MESA ENMANGADO
HOJA LISA
24,6 CM - 9 IN^{11/16}



105860
COUTEAU DE TABLE MANCHE ORFÈVRE DROIT LAME SCIE
TABLE KNIFE HOLLOW HANDLE SERRATED
CUCHILLO DE MESA ENMANGADO
HOJA SIERRA
24,6 CM - 9 IN^{11/16}



105801
COUTEAU À STEAK MANCHE ORFÈVRE LAME SCIE
STEAK KNIFE HOLLOW HANDLE SERRATED
CUCHILLO DE STEAK ENMANGADO
HOJA SIERRA
23,9 CM - 9 IN^{7/16}



105798
CUILLÈRE DE TABLE
TABLE/PASTA SPOON
CUCHARA DE MESA
20,8 CM - 8 IN^{3/16}



105908
CUILLÈRE À SOUPE ANGLAISE
BOUILLON SPOON, ROUND
CUCHARA DE CONSOMÉ
17,2 CM - 6 IN^{3/4}



105861
CUILLÈRE À DESSERT
DESSERT/SOUP SPOON, OVAL
CUCHARA DE POSTRE
18 CM - 7 IN^{1/16}



105885
FOURCHETTE À DESSERT
DESSERT/SALAD FORK
TENEDOR DE POSTRE
17,8 CM - 7 IN



182463
COUTEAU À DESSERT MONOBLOC LOURD LAME UNIE
DESSERT KNIFE HEAVY SOLID HANDLE
CUCHILLO DE POSTRE PESADO
HOJA LISA
21,1 CM - 8 IN^{5/16}



105832
COUTEAU À DESSERT MANCHE ORFÈVRE LAME UNIE
DESSERT KNIFE HOLLOW HANDLE
CUCHILLO DE POSTRE RECTO MANGO
ENMANGADO HOJA LISA
20,5 CM - 8 IN^{1/16}



190420
COUTEAU À BEURRE MONOBLOC LOURD LAME UNIE
BUTTER KNIFE HEAVY SOLID HANDLE
CUCHILLO DE MANTEQUILLA
PESADO HOJA LISA
19 CM - 7 IN^{1/2}



003332
COUTEAU À BEURRE MANCHE ORFÈVRE LAME UNIE
BUTTER KNIFE HOLLOW HANDLE
CUCHILLO DE MANTEQUILLA
ENMANGADO HOJA LISA
18,7 CM - 7 IN^{3/8}



108918
FOURCHETTE À POISSON
FISH FORK
TENEDOR DE PESCADO
17,8 CM - 7 IN



108920
COUTEAU À POISSON
FISH KNIFE
CUCHILLO DE PESCADO
19,7 CM - 7 IN^{3/4}



105910
CUILLÈRE À SAUCE GOURMET
GOURMET/SAUCE SPOON
CUCHARA PARA SALSA
17,9 CM - 7 IN^{1/16}



105833
CUILLÈRE À CAFÉ
COFFEE/TEA SPOON
CUCHARA DE CAFÉ
14 CM - 5 IN^{1/2}



105906
CUILLÈRE À MOKA
DEMI TASSE SPOON
CUCHARA DE MOKA
11 CM - 4 IN^{5/16}



105800
CUILLÈRE À SODA
ICED TEA SPOON
CUCHARA DE SODA/HELADO
18,2 CM - 7 IN^{3/16}



105795
FOURCHETTE À GÂTEAUX/ COCKTAIL
PASTRY/COCKTAIL FORK
TENEDOR DE PASTEL
13,8 CM - 5 IN^{7/16}



VERLAINE

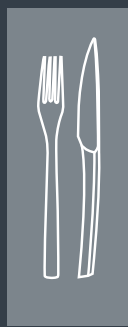



123440
FOURCHETTE À HUÎTRES
OYSTER FORK
TENEDOR DE OSTRAS
12,9 CM - 5 IN^{1/16}



132782
FOURCHETTE À ESCARGOTS
SNAIL FORK
TENEDOR DE CARACOLAS
13,5 CM - 5 IN^{5/16}



130994
CUILLÈRE À TOASTS
APPETIZER SPOON
CUCHARA PARA APERITIVO
11,8 CM - 7 IN^{7/16}



003390
COUTEAU À FROMAGES
MANCHE ORFÈVRE LAME UNIE
CHEESE KNIFE HOLLOW HANDLE
CUCHILLO DE QUESO ENMANGADO
19,3 CM - 7 IN^{5/8}



002185
FOURCHETTE DE SERVICE
SERVING FORK
TENEDOR DE SERVICIO/ENSALADA
24,8 CM - 9 IN^{3/4}



002186
CUILLÈRE DE SERVICE
SERVING SPOON
CUCHARA DE SERVICIO/ENSALADA
25 CM - 9 IN^{3/16}



040646
SERVICE À SALADE
SALAD SERVING SET
SET SERVICIO DE ENSALADA
25,8 CM - 10 IN^{3/16}



083340
PELLE À TARTE MONOBLOC
PASTRY SERVER SOLID HANDLE
PALA PARA TARTA
24,9 CM - 9 IN^{3/16}



097717
LOUCHE
SOUP LADLE
CAZO
29,8 CM - 11 IN^{3/4}



002179
LOUCHE À SAUCE
SAUCE LADLE
CAZO PARA SALSA
15,7 CM - 6 IN^{3/16}



002191
PINCE À SUCRE
SUGAR TONG
PINZA PARA AZÚCAR
11,5 CM - 4 IN^{1/2}



Possibilité de personnalisation
Bespoke options available - Posibilidad de personalización



VERLAINE

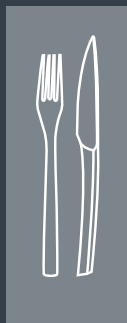



105021
FOURCHETTE DE TABLE
TABLE FORK
TENEDOR DE MESA
20,9 CM - 8 IN^{3/16}



190415
**COUTEAU DE TABLE
MONOBLOC LOURD LAME SCIE**
TABLE KNIFE HEAVY SOLID HANDLE SERRATED
CUCHILLO DE MESA PESADO
HOJA SIERRA
24,8 CM - 9 IN^{3/4}



105006
**COUTEAU DE TABLE
MANCHE ORFÈVRE LAME SCIE**
TABLE KNIFE HOLLOW HANDLE SERRATED
CUCHILLO DE MESA ENMANGADO
HOJA SIERRA
24,7 CM - 9 IN^{3/4}



122746
**COUTEAU À STEAK
MANCHE ORFÈVRE LAME SCIE**
STEAK KNIFE HOLLOW HANDLE SERRATED
CUCHILLO DE STEAK ENMANGADO
HOJA SIERRA
23,8 CM - 9 IN^{3/8}



104988
CUILLÈRE DE TABLE
TABLE/PASTA SPOON
CUCHARA DE MESA
21,1 CM - 8 IN^{5/16}



104975
CUILLÈRE À SOUPE ANGLAISE
BOUILLON SPOON, ROUND
CUCHARA DE CONSOMÉ
17,4 CM - 6 IN^{3/8}



104985
CUILLÈRE À DESSERT
DESSERT/SOUP SPOON, OVAL
CUCHARA DE POSTRE
18 CM - 7 IN^{1/16}



105013
FOURCHETTE À DESSERT
DESSERT/SALAD FORK
TENEDOR DE POSTRE
17,9 CM - 7 IN^{1/16}



190416
**COUTEAU À DESSERT
MONOBLOC LOURD LAME UNIE**
DESSERT KNIFE HEAVY SOLID HANDLE
CUCHILLO DE POSTRE PESADO
HOJA LISA
21,3 CM - 8 IN^{3/8}



104989
**COUTEAU À DESSERT
MANCHE ORFÈVRE LAME UNIE**
DESSERT KNIFE HOLLOW HANDLE
CUCHILLO DE POSTRE ENMANGADO
HOJA LISA
20,6 CM - 8 IN^{1/8}



190414
**COUTEAU À BEURRE
MONOBLOC LOURD
LAME UNIE**
BUTTER KNIFE HEAVY SOLID HANDLE
CUCHILLO DE MANTEQUILLA
PESADO HOJA LISA
19,7 CM - 7 IN^{3/4}



016394
**COUTEAU À BEURRE
MANCHE ORFÈVRE LAME UNIE**
BUTTER KNIFE HOLLOW HANDLE
CUCHILLO DE MANTEQUILLA
ENMANGADO HOJA LISA
18,9 CM - 7 IN^{7/16}



104994
FOURCHETTE À POISSON
FISH FORK
TENEDOR DE PESCADO
17,9 CM - 7 IN^{1/16}



104995
COUTEAU À POISSON
FISH KNIFE
CUCHILLO DE PESCADO
20 CM - 7 IN^{7/8}



104977
CUILLÈRE À SAUCE GOURMET
GOURMET/SAUCE SPOON
CUCHARA PARA SALSA
18 CM - 7 IN^{1/16}



104986
CUILLÈRE À CAFÉ
COFFEE/TEA SPOON
CUCHARA DE CAFÉ
14,1 CM - 5 IN^{9/16}



104993
CUILLÈRE À MOKA
DEMI TASSE SPOON
CUCHARA DE MOKA
11,2 CM - 4 IN^{7/16}



105012
**FOURCHETTE À GÂTEAUX/
COCKTAIL**
PASTRY/COCKTAIL FORK
TENEDOR DE PASTEL
13,9 CM - 5 IN^{1/2}



LUTÈCE





104485
FOURCHETTE DE TABLE
TABLE FORK
TENEDOR DE MESA
20,8 CM - 8 IN^{3/16}



182466
COUPEAU DE TABLE MONOBLOC LOURD LAME SCIE
TABLE KNIFE HEAVY SOLID HANDLE
SERRATED
CUCHILLO DE MESA PESADO
HOJA SIERRA
24,6 CM - 9 IN^{11/16}



161390
COUPEAU DE TABLE MANCHE ORFÈVRE DROIT LAME UNIE
TABLE KNIFE HOLLOW HANDLE
CUCHILLO DE MESA ENMANGADO
HOJA LISA
24,6 CM - 9 IN^{11/16}



161391
COUPEAU DE TABLE MANCHE ORFÈVRE LAME SCIE
TABLE KNIFE HOLLOW HANDLE SERRATED
CUCHILLO DE MESA ENMANGADO
HOJA SIERRA
24,6 CM - 9 IN^{11/16}



122759
COUPEAU À STEAK MANCHE ORFÈVRE LAME SCIE
STEAK KNIFE HOLLOW HANDLE SERRATED
CUCHILLO DE STEAK ENMANGADO
HOJA SIERRA
23,9 CM - 9 IN^{7/16}



104526
CUILLÈRE DE TABLE
TABLE/PASTA SPOON
CUCHARA DE MESA
20,8 CM - 8 IN^{3/16}



112695
CUILLÈRE À SOUPE ANGLAISE
BOUILLON SPOON, ROUND
CUCHARA DE CONSOMÉ
17,2 CM - 6 IN^{3/4}



104484
CUILLÈRE À DESSERT
DESSERT/SOUP SPOON, OVAL
CUCHARA DE POSTRE
18 CM - 7 IN^{1/16}



104543
FOURCHETTE À DESSERT
DESSERT/SALAD FORK
TENEDOR DE POSTRE
17,8 CM - 7 IN



182467
COUPEAU À DESSERT MONOBLOC LOURD LAME UNIE
DESSERT KNIFE HEAVY SOLID HANDLE
CUCHILLO DE POSTRE PESADO
HOJA LISA
20,5 CM - 8 IN^{1/16}



161394
COUPEAU À DESSERT MANCHE ORFÈVRE LAME UNIE
DESSERT KNIFE HOLLOW HANDLE
CUCHILLO DE POSTRE RECTO MANGO
ENMANGADO HOJA LISA
20,5 CM - 8 IN^{1/16}



190419
COUPEAU À BEURRE MONOBLOC LOURD LAME UNIE
BUTTER KNIFE HEAVY SOLID HANDLE
CUCHILLO DE MANTEQUILLA
PESADO HOJA LISA
18,7 CM - 7 IN^{3/8}



122760
COUPEAU À BEURRE MANCHE ORFÈVRE LAME UNIE
BUTTER KNIFE HOLLOW HANDLE
CUCHILLO DE MANTEQUILLA
ENMANGADO HOJA LISA
18,7 CM - 7 IN^{3/8}



108922
FOURCHETTE POISSON
FISH FORK
TENEDOR DE PESCADO
17,8 CM - 7 IN



108924
COUPEAU POISSON
FISH KNIFE
CUCHILLO DE PESCADO
19,7 CM - 7 IN^{3/4}



145451
CUILLÈRE À SAUCE GOURMET
GOURMET/SAUCE SPOON
CUCHARA PARA SALSA
17,9 CM - 7 IN^{1/16}



104561
CUILLÈRE À CAFÉ
COFFEE/TEA SPOON
CUCHARA DE CAFÉ
14 CM - 5 IN^{1/2}



161398
CUILLÈRE À MOKA
DEMI TASSE SPOON
CUCHARA DE MOKA
11 CM - 4 IN^{5/16}



124259
CUILLÈRE À SODA
ICED TEA SPOON
CUCHARA DE SODA/HELADO
18,2 CM - 7 IN^{3/16}



104480
FOURCHETTE À GÂTEAUX/ COCKTAIL
PASTRY/COCKTAIL FORK
TENEDOR DE PASTEL
13,8 CM - 5 IN^{7/16}



123434
FOURCHETTE À HUITRES
OYSTER FORK
TENEDOR DE OSTRAS
12,9 CM - 5 IN^{1/16}

Possibilité de personnalisation
Bespoke options available - Posibilidad de personalización



©Patrick ROUGEREAU
L'alcool est dangereux pour la santé
Degrime promotes responsible drinking and discourages alcohol misuse
El abuso de alcohol es peligroso para la salud

BLOIS





189208
COUPEAU À FROMAGE
MANCHE ORFÈVRE LAME UNIE
 CHEESE KNIFE HOLLOW HANDLE
 CUCHILLO DE QUESO ENMANGADO
 19,3 CM - 7 IN^{5/8}



195757
FOURCHETTE DE SERVICE
 SERVING FORK
 TENEDOR DE SERVICIO/ENSALADA
 24,8 CM - 9 IN^{3/4}



195755
CUILLÈRE DE SERVICE
 SERVING SPOON
 CUCHARA DE SERVICIO/ENSALADA
 25 CM - 9 IN^{3/16}



195757
FOURCHETTE À DÉCOUPER
 CARVING FORK
 TENEDOR TRINCHANTE
 24,8 CM - 9 IN^{3/4}



189511
COUPEAU À DÉCOUPER
MANCHE ORFÈVRE LAME UNIE
 CARVING KNIFE HOLLOW HANDLE
 CUCHILLO TRINCHANTE ENMANGADO
 HOJA LISA
 28,7 CM - 11 IN^{5/16}



195750
SERVICE À SALADE
 SALADE SERVING SET
 SET SERVICIO DE ENSALADA
 25,7 CM - 10 IN^{1/8}



195753
PELLE À TARTE MONOBLOC
 PASTRY SERVER SOLID HANDLE
 PALA PARA TARTA
 24,9 CM - 9 IN^{13/16}



195762
LOUCHE
 SOUP LADLE
 CAZO
 29,8 CM - 11 IN^{3/4}



195759
LOUCHE À SAUCE
 SAUCE LADLE
 CAZO PARA SALSA
 15,7 CM - 6 IN^{3/16}



Possibilité de personnalisation
 Bespoke options available - Posibilidad de personalización



BLOIS

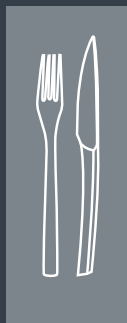



141089
FOURCHETTE DE TABLE
TABLE FORK
TENEDOR DE MESA
20,3 CM - 8 IN

113017
**COUPEAU DE TABLE
MONOBLOC LOURD
LAME SCIE**
TABLE KNIFE HEAVY SOLID HANDLE
SERRATED
CUCHILLO DE MESA PESADO
HOJA SIERRA
24,4 CM - 9 IN^{5/8}

160427
**COUPEAU À STEAK
MONOBLOC LAME SCIE**
STEAK KNIFE SOLID HANDLE
SERRATED
CUCHILLO DE STEAK
HOJA SIERRA
23,2 CM - 9 IN^{7/8}

141086
CUILLÈRE DE TABLE
TABLE/PASTA SPOON
CUCHARA DE MESA
20,4 CM - 8 IN^{1/16}

112695
CUILLÈRE À SOUPE ANGLAISE
BOUILLON SPOON, ROUND
CUCHARA DE CONSOMÉ
17,2 CM - 6 IN^{3/4}

108236
CUILLÈRE À DESSERT
DESSERT/SOUP SPOON, OVAL
CUCHARA DE POSTRE
17,9 CM - 7 IN^{1/16}

108238
FOURCHETTE À DESSERT
DESSERT/SALAD FORK
TENEDOR DE POSTRE
17,8 CM - 7 IN

113019
**COUPEAU À DESSERT
MONOBLOC LOURD
LAME UNIE**
DESSERT KNIFE HEAVY SOLID HANDLE
CUCHILLO DE POSTRE PESADO
HOJA LISA
21 CM - 8 IN^{3/4}

189971
**COUPEAU À BEURRE
MONOBLOC LAME UNIE**
BUTTER KNIFE SOLID HANDLE
CUCHILLO DE MANTEQUILLA
HOJA LISA
18,9 CM - 7 IN^{7/16}

108922
FOURCHETTE À POISSON
FISH FORK
TENEDOR DE PESCADO
17,8 CM - 7 IN

108924
COUPEAU À POISSON
FISH KNIFE
CUCHILLO DE PESCADO
19,7 CM - 7 IN^{3/4}



103550
CUILLÈRE À CAFÉ
COFFEE/TEA SPOON
CUCHARA DE CAFÉ
13,5 CM - 5 IN^{5/16}



109465
CUILLÈRE À MOKA
DEMI TASSE SPOON
CUCHARA DE MOKA
11 CM - 4 IN^{5/16}



124259
CUILLÈRE À SODA
ICED TEA SPOON
CUCHARA DE SODA/HELADO
18,2 CM - 7 IN^{3/16}



109466
**FOURCHETTE À GÂTEAUX/
COCKTAIL**
PASTRY/COCKTAIL FORK
TENEDOR DE PASTEL
15 CM - 5 IN^{7/8}



123434
FOURCHETTE À HÛITRES
OYSTER FORK
TENEDOR DE OSTRAS
12,9 CM - 5 IN^{1/16}



195757
FOURCHETTE DE SERVICE
SERVING FORK
TENEDOR DE SERVICIO/ENSALADA
24,8 CM - 9 IN^{3/4}



195755
CUILLÈRE DE SERVICE
SERVING SPOON
CUCHARA DE SERVICIO/ENSALADA
25 CM - 9 IN^{13/16}



195750
SERVICE À SALADE
SALAD SERVING SET
SET SERVICIO/ENSALADA
25,7 CM - 10 IN^{7/8}



195753
PELLE À TARTE MONOBLOC
PASTRY SERVER SOLID HANDLE
PALA PARA TARTA
24,9 CM - 9 IN^{13/16}



195762
LOUCHE
SOUP LADLE
CAZO
29,8 CM - 11 IN^{3/4}



195759
LOUCHE À SAUCE
SAUCE LADLE
CAZO PARA SALSA
15,7 CM - 6 IN^{3/16}

Possibilité de personnalisation
Bespoke options available - Posibilidad de personalización



MIKADO MIROIR



DEGRÈNNE





230285
FOURCHETTE DE TABLE
 TABLE FORK
 TENEDOR DE MESA
 20,3 CM - 8 IN



230287
**COUTEAU DE TABLE
 MONOBLOC LOURD LAME SCIE**
 TABLE KNIFE HEAVY SOLID HANDLE
 SERRATED
 CUCHILLO DE MESA PESADO
 HOJA SIERRA
 24,4 CM - 9 IN^{5/8}



230293
**COUTEAU À STEAK
 MONOBLOC LAME SCIE**
 STEAK KNIFE SOLID HANDLE
 SERRATED
 CUCHILLO DE STEAK
 HOJA SIERRA
 23,2 CM - 9 IN^{1/8}



230286
CUILLÈRE DE TABLE
 TABLE/PASTA SPOON
 CUCHARA DE MESA
 20,4 CM - 8 IN^{1/16}



230291
CUILLÈRE À DESSERT
 DESSERT/SOUP SPOON, OVAL
 CUCHARA DE POSTRE
 17,9 CM - 7 IN^{1/16}



230290
FOURCHETTE À DESSERT
 DESSERT/SALAD FORK
 TENEDOR DE POSTRE
 17,8 CM - 7 IN



230292
**COUTEAU À DESSERT
 MONOBLOC LOURD LAME UNIE**
 DESSERT KNIFE HEAVY SOLID HANDLE
 CUCHILLO DE POSTRE PESADO
 HOJA LISA
 21 CM - 8 IN^{1/4}



232308
**COUTEAU À BEURRE
 MONOBLOC LAME UNIE**
 BUTTER KNIFE SOLID HANDLE
 CUCHILLO DE MANTEQUILLA
 HOJA LISA
 18,9 CM - 7 IN^{7/16}



230288
CUILLÈRE À CAFÉ
 COFFEE/TEA SPOON
 CUCHARA DE CAFÉ
 13,5 CM - 5 IN^{5/16}



230289
CUILLÈRE À MOKA
 DEMI TASSE SPOON
 CUCHARA DE MOKA
 11 CM - 4 IN^{5/16}



18-10



MIKADO VINTAGE





141094
FOURCHETTE DE TABLE
TABLE FORK
TENEDOR DE MESA
20,3 CM - 8 IN



103564
CUILLÈRE À CAFÉ
COFFEE/TEA SPOON
CUCHARA DE CAFÉ
13,5 CM - 5 IN^{5/16}



103857
COUTEAU DE TABLE MONOBLOC LAME SCIE
TABLE KNIFE SOLID HANDLE SERRATED
CUCHILLO DE MESA HOJA SIERRA
23,7 CM - 9 IN^{5/16}



109471
CUILLÈRE À MOKA
DEMI TASSE SPOON
CUCHARA DE MOKA
11 CM - 4 IN^{5/16}



160433
COUTEAU À STEAK MONOBLOC LAME SCIE
STEAK KNIFE SOLID HANDLE SERRATED
CUCHILLO DE STEAK HOJA SIERRA
23,6 CM - 9 IN^{5/16}



105800
CUILLÈRE À SODA
ICED TEA SPOON
CUCHARA DE SODA/HELADO
18,2 CM - 7 IN^{3/16}



141092
CUILLÈRE DE TABLE
TABLE/PASTA SPOON
CUCHARA DE MESA
20,4 CM - 8 IN^{1/16}



109472
FOURCHETTE À GÂTEAUX/ COCKTAIL
PASTRY/COCKTAIL FORK
TENEDOR DE PASTEL
15 CM - 5 IN^{7/8}



112692
CUILLÈRE À SOUPE ANGLAISE
BOUILLON SPOON, ROUND
CUCHARA DE CONSOMÉ
17,2 CM - 6 IN^{3/4}



123440
FOURCHETTE À HÙÎTRES
OYSTER FORK
TENEDOR DE OSTRAS
12,9 CM - 5 IN^{1/16}



108232
CUILLÈRE À DESSERT
DESSERT/SOUP SPOON, OVAL
CUCHARA DE POSTRE
17,9 CM - 7 IN^{1/16}



132782
FOURCHETTE À ESCARGOTS
SNAIL FORK
TENEDOR DE CARACOLAS
13,5 CM - 5 IN^{5/16}



108234
FOURCHETTE À DESSERT
DESSERT/SALAD FORK
TENEDOR DE POSTRE
17,8 CM - 7 IN



002185
FOURCHETTE DE SERVICE
SERVING FORK
TENEDOR DE SERVICIO/ENSALADA
24,8 CM - 9 IN^{3/4}



210628
COUTEAU À DESSERT MONOBLOC LAME SCIE
DESSERT KNIFE SOLID HANDLE
CUCHILLO DE POSTRE HOJA SIERRA
20,6 CM - 8 IN^{7/8}



002186
CUILLÈRE DE SERVICE
SERVING SPOON
CUCHARA DE SERVICIO/ENSALADA
25 CM - 9 IN^{13/16}



108918
FOURCHETTE À POISSON
FISH FORK
TENEDOR DE PESCADO
17,8 CM - 7 IN



040646
SERVICE À SALADE
SALAD SERVING SET
SET SERVICIO/ENSALADA
25,8 CM - 10 IN^{3/16}



108920
COUTEAU À POISSON
FISH KNIFE
CUCHILLO DE PESCADO
19,7 CM - 7 IN^{3/4}



083340
PELLE À TARTE MONOBLOC
PASTRY SERVER SOLID HANDLE
PALA PARA TARTA
24,9 CM - 9 IN^{13/16}



097717
LOUCHE
SOUP LADLE
CAZO
29,8 CM - 11 IN^{3/4}



002179
LOUCHE À SAUCE
SAUCE LADLE
CAZO PARA SALSA
15,7 CM - 6 IN^{3/16}

Possibilité de personnalisation
Bespoke options available - Posibilidad de personalización



CONFIDENCE



DEGRÈNE





105804
FOURCHETTE DE TABLE
TABLE FORK
TENEDOR DE MESA
21 CM - 8 IN^{1/4}



105837
FOURCHETTE À POISSON
FISH FORK
TENEDOR DE PESCADO
18 CM - 7 IN^{7/8}



105892
COUTEAU DE TABLE MONOBLOC LAME SCIE
TABLE KNIFE SOLID HANDLE SERRATED
CUCHILLO DE MESA HOJA SIERRA
25 CM - 9 IN^{13/16}



105912
COUTEAU À POISSON
FISH KNIFE
CUCHILLO DE PESCADO
20 CM - 7 IN^{7/8}



105864
COUTEAU DE TABLE MANCHE ORFÈVRE LAME UNIE
TABLE KNIFE HOLLOW HANDLE
CUCHILLO DE MESA ENMANGADO HOJA LISA
24,7 CM - 9 IN^{3/4}



105838
CUILLÈRE À CAFÉ
COFFEE/TEA SPOON
CUCHARA DE CAFÉ
14,1 CM - 5 IN^{9/16}



105913
COUTEAU DE TABLE MANCHE ORFÈVRE LAME SCIE
TABLE KNIFE HOLLOW HANDLE SERRATED
CUCHILLO DE MESA ENMANGADO HOJA SIERRA
24,7 CM - 9 IN^{3/4}



105891
CUILLÈRE À MOKA
DEMI TASSE SPOON
CUCHARA DE MOKA
11 CM - 4 IN^{5/16}



160424
COUTEAU À STEAK MONOBLOC LAME SCIE
STEAK KNIFE SOLID HANDLE SERRATED
CUCHILLO DE STEAK HOJA SIERRA
23,2 CM - 9 IN^{1/8}



105805
FOURCHETTE À GÂTEAUX/ COCKTAIL
PASTRY/COCKTAIL FORK
TENEDOR DE PASTEL
13,9 CM - 5 IN^{1/2}



105911
CUILLÈRE DE TABLE
TABLE/PASTA SPOON
CUCHARA DE MESA
21 CM - 8 IN^{1/4}



105803
FOURCHETTE À HÙITRES
OYSTER FORK
TENEDOR DE OSTRAS
13,2 CM - 5 IN^{3/16}



105863
CUILLÈRE À DESSERT
DESSERT/SOUP SPOON, OVAL
CUCHARA DE POSTRE
18 CM - 7 IN^{1/16}



000490
FOURCHETTE DE SERVICE
SERVING FORK
TENEDOR DE SERVICIO/ENSALADA
24,6 CM - 9 IN^{11/16}



105890
FOURCHETTE À DESSERT
DESSERT/SALAD FORK
TENEDOR DE POSTRE
18 CM - 7 IN^{1/16}



000491
CUILLÈRE DE SERVICE
SERVING SPOON
CUCHARA DE SERVICIO/ENSALADA
24,9 CM - 9 IN^{13/16}



210626
COUTEAU À DESSERT MONOBLOC LAME SCIE
DESSERT KNIFE SOLID HANDLE SERRATED
CUCHILLO DE POSTRE HOJA SIERRA
20,7 CM - 8 IN^{11/8}



105802
COUTEAU À DESSERT MANCHE ORFÈVRE LAME UNIE
DESSERT KNIFE HOLLOW HANDLE SERRATED
CUCHILLO DE POSTRE ENMANGADO HOJA LISA
20,5 CM - 8 IN^{1/16}



VIEUX PARIS SATINÉ



DEGRÈNE

MIRAGE LES ESSENCES



233848
COUTEAU À STEAK MANCHE OLIVIER
STEAK KNIFE OLIVE WOOD HANDLE
CUCHILLO STEAK MANGO DE MADERA DE OLIVO
23 CM - 9 IN^{17/16}



233853
COUTEAU À STEAK MANCHE PICANA
STEAK KNIFE PICANA HANDLE
CUCHILLO STEAK MANGO DE PICANA
23 CM - 9 IN^{17/16}



233851
COUTEAU À STEAK MANCHE ÉBÈNE
STEAK KNIFE EBONY HANDLE
CUCHILLO STEAK MANGO DE ÉBANO
23 CM - 9 IN^{17/16}

MIRAGE



226261
COUTEAU DE TABLE/ STEAK LAME UNIE ANTHRACITE
BLACK TABLE STEAK KNIFE
CUCHILLO STEAK NEGRO
23 CM - 9 IN^{17/16}



226263
COUTEAU DE TABLE/ STEAK LAME UNIE BLANC
WHITE TABLE STEAK KNIFE
CUCHILLO STEAK BLANCO
23 CM - 9 IN^{17/16}

LAGUIOLE



232249
COUTEAU LAGUIOLE - CORNE NOIRE - MITRE INOX
LAGUIOLE STEAK KNIFE BLACK HORN - STEEL BOLSTER
LAGUIOLE CUCHILLO STEAK CUERNO - MITRA ACERO
23 CM - 9 IN^{17/16}



232251
COUTEAU LAGUIOLE - CORNE CLAIRE - MITRE LAITON
LAGUIOLE STEAK KNIFE LIGHT HORN - BRASS BOLSTER
LAGUIOLE CUCHILLO STEAK CUERNO CLARO - MITRA LATON
23 CM - 9 IN^{17/16}



232253
COUTEAU LAGUIOLE - IVOIRINE - MITRE INOX
LAGUIOLE STEAK KNIFE IVORY COLOR - STEEL BOLSTER
LAGUIOLE CUCHILLO STEAK COLOR MARFILL - MITRA ACERO
23 CM - 9 IN^{17/16}



232255
COUTEAU LAGUIOLE - OLIVIER - MITRE LAITON
LAGUIOLE STEAK KNIFE OLIVE WOOD - BRASS BOLSTER
LAGUIOLE CUCHILLO STEAK OLIVO - MITRA LATON
23 CM - 9 IN^{17/16}

CAPUCIN



232243
COUTEAU À STEAK CAPUCIN NOIR
CAPUCIN STEAK KNIFE - BLACK
CAPUCIN CUCHILLO STEAK - NEGRO
22,6 CM - 8 IN^{7/8}



232245
COUTEAU À STEAK CAPUCIN IVOIRINE
CAPUCIN STEAK KNIFE - IVORY COLOR
CAPUCIN CUCHILLO STEAK - COLOR MARFILL
22,6 CM - 8 IN^{7/8}



232247
COUTEAU À STEAK CAPUCIN ROUGE
CAPUCIN STEAK KNIFE - RED
CAPUCIN CUCHILLO STEAK - ROJO
22,6 CM - 8 IN^{7/8}

Alldaydining

COUTEAUX À STEAK

MADE IN FRANCE

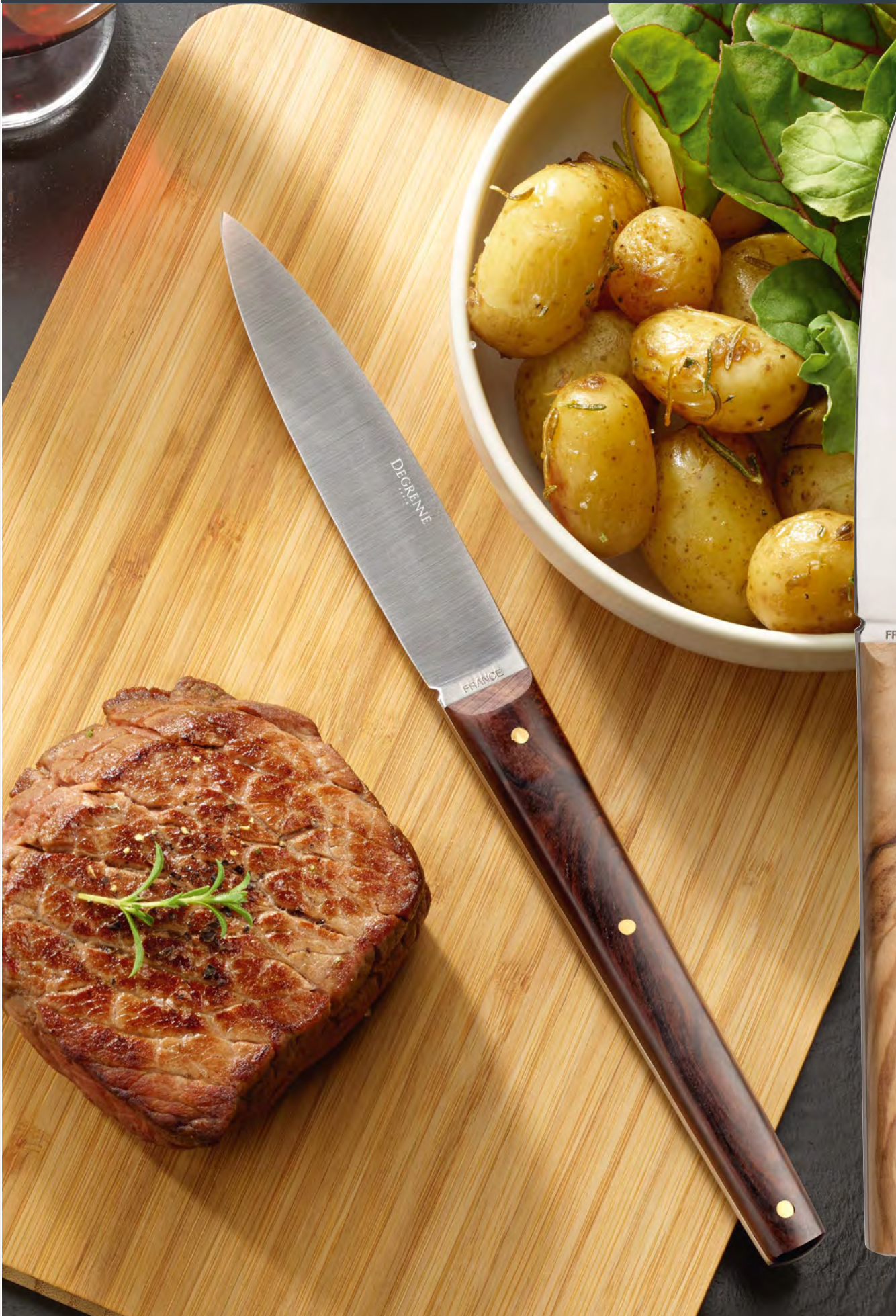

PIÈCES COMPLÉMENTAIRES



190018
CUILLÈRE À SODA
ICED TEA SPOON
CUCHARA DE SODA/HELADO
19 CM - 7 IN^{1/2}



189973
CUILLÈRE À SODA
ICED TEA SPOON
CUCHARA DE SODA/HELADO
19 CM - 7 IN^{1/2}



226175
CUILLÈRE À SODA
ICED TEA SPOON
CUCHARA DE SODA/HELADO
19 CM - 7 IN^{1/2}



162724
CUILLÈRE À AGRUMES
CITRUS FRUITS SPOON
CUCHARA PARA POMELO
15,3 CM - 6 IN



190424
FOURCHETTE À HUÎTRES
OYSTER FORK
TENEDOR DE OSTRAS
14,1 CM - 5 IN^{9/16}



189974
FOURCHETTE À HUÎTRES
OYSTER FORK
TENEDOR DE OSTRAS
14,1 CM - 5 IN^{9/16}



162728
FOURCHETTE / PIQUE À ESCARGOTS/COCKTAIL
COCKTAIL, SNAIL FORK
TENEDOR DE CARACOL/COCKTAIL
10,8 CM - 4 IN^{1/4}



162730
CURETTE À CRUSTACÉS
SEAFOOD SCRAPER
RASQUETA PARA CANGREJO
19,1 CM - 7 IN^{1/2}



154612
COUTEAU À BEURRE MONOBLOC LAME UNIE
BUTTER KNIFE SOLID HANDLE
CUCHILLO DE MANTEQUILLA HOJA LISA
19,4 CM - 7 IN^{3/8}



189971
COUTEAU À BEURRE MONOBLOC LAME UNIE
BUTTER KNIFE SOLID HANDLE
CUCHILLO DE MANTEQUILLA HOJA LISA
18,9 CM - 7 IN^{7/16}



159451
COUTEAU À STEAK MONOBLOC LAME SCIE
STEAK KNIFE SOLID HANDLE SERRATED
CUCHILLO DE STEAK HOJA SIERRA
23,5 CM - 9 IN^{1/4}



122418
COUTEAU À STEAK MONOBLOC LAME SCIE
STEAK KNIFE SOLID HANDLE SERRATED
CUCHILLO DE STEAK HOJA SIERRA
22,1 CM - 8 IN^{11/16}



184492
PINCE À CRUSTACÉ
SEAFOOD CRACKER
TENACILLAS PARA CRUSTÁCEOS
16,5 CM - 6 IN^{1/2}



004013
PINCE À ESCARGOTS
SNAIL TONG
PINZAS CARACOL
16 CM - 6 IN^{5/16}



204498 101492
PINCE À PAIN
BREAD TONG
PINZAS PAN
23 CM - 9 IN^{1/16}



204497 101493
PINCE À HOMARD
LOBSTER CRACKER
TENACILLAS PARA BOGAVANTE
18,5 CM - 7 IN^{5/16}



204496 101494
CISEAUX À GÂTEAUX
PASTRY CISSORS/TONG
PINZAS PARA PASTELES
20 CM - 7 IN^{7/8}



204499 184355
PINCE À SERVIR
SERVING TONG
PINZAS PARA SERVIR
29,5 CM - 11 IN^{5/8}

PETIT GOURMET



207257 207538
FOURCHETTE À DESSERT
 DESSERT/SALAD FORK
 TENEDOR DE POSTRE
 16,5 CM - 6 IN^{1/2}



207259 207540
**COUTEAU À DESSERT
 MONBLOC LAME UNIE**
 DESSERT KNIFE SOLID HANDLE
 CUCHILLO DE POSTRE HOJA LISA
 17,7 CM - 6 IN^{5/16}



207258 207539
CUILLÈRE À DESSERT
 DESSERT/SOUP SPOON, OVAL
 CUCHARA DE POSTRE
 16,5 CM - 6 IN^{1/2}



207256 207537
CUILLÈRE À CAFÉ
 COFFEE/TEA SPOON
 CUCHARA DE CAFÉ
 13,2 CM - 5 IN^{3/16}



**DES LIGNES DOUCES ET UNE TAILLE ADAPTÉE AUX MAINS DES ENFANTS
 POUR FAIRE DE LEUR REPAS UN MOMENT EXQUIS**

SOFT LINES AND A CHILD-FRIENDLY SIZE TO MAKE CHILDREN'S
 MEALTIMES A MAGIC MOMENT

LÍNEAS SUAVES Y UN TAMAÑO ADAPTADO A LAS MANOS DE LOS NIÑOS
 PARA CONVERTIR LA COMIDA EN UN MOMENTO EXQUISITO



18-10



Possibilité de personnalisation

Bespoke options available - Posibilidad de personalización



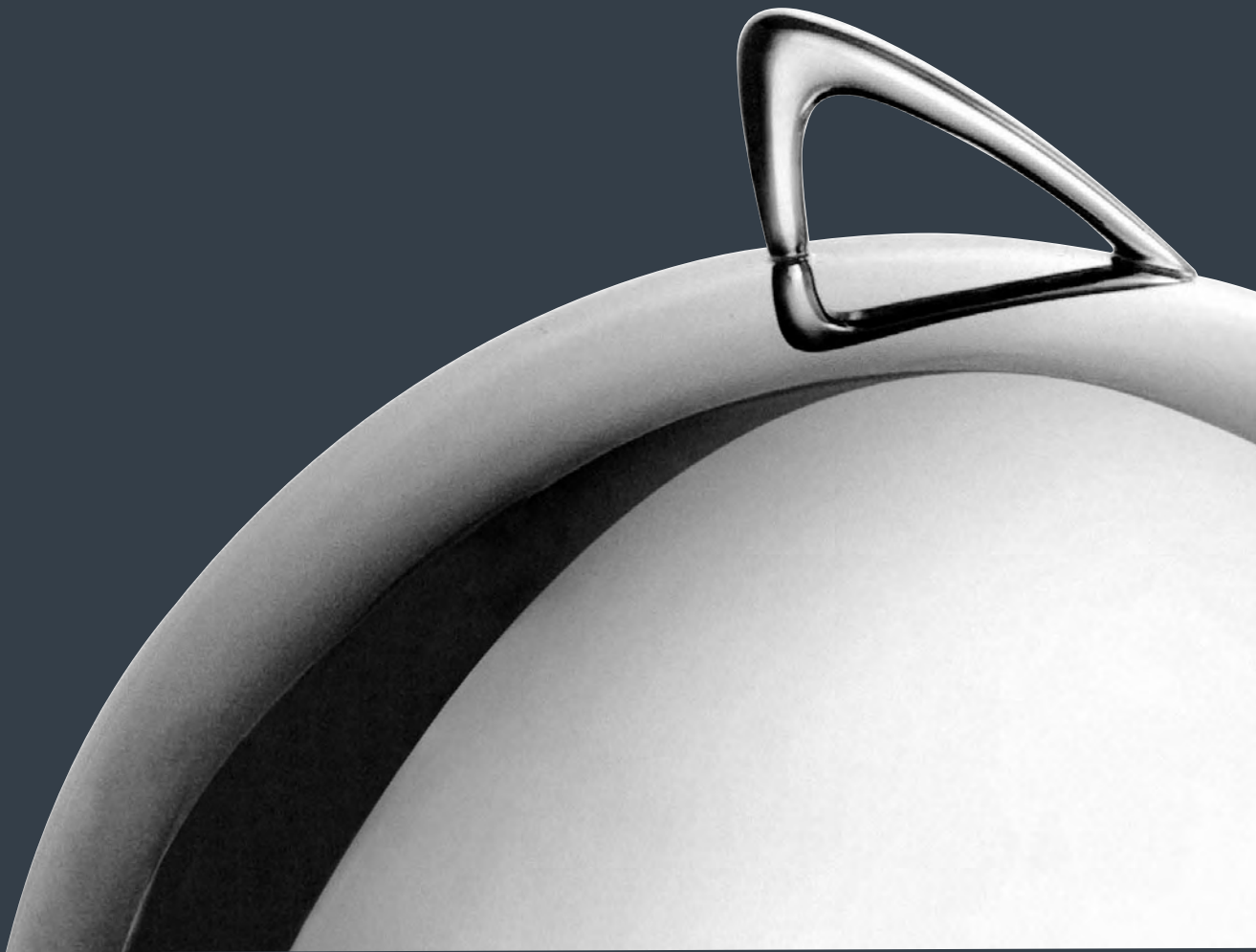



PLATERIE

A travers des objets en acier dédiés à la table, au service et à la dégustation, DEGRENNE exprime la richesse de son métier d'orfèvre. Des pièces de forme aux **lignes raffinées** jusqu'aux accessoires présentés sur la table des convives, **la collection platerie DEGRENNE s'accorde parfaitement avec l'ensemble des gammes pour offrir un service élégant et moderne.**

HOLLOWARE

DEGRENNE expresses its highly-varied metal-working expertise through steel products designed for the table, service and tasting and appreciating. From shaped pieces with **sophisticated lines** to accessories showcased on the guests' table, **DEGRENNE's holloware collection fits perfectly with all the other ranges**, making for an **elegant and contemporary service.**

ORFEBRERÍA

A través de los objetos de acero dedicados a la mesa, al servicio y a la degustación, DEGRENNE expresa la riqueza de su oficio de orfebre. Desde piezas de forma con **líneas refinadas** hasta accesorios presentados en la mesa de los invitados, **la colección de platería DEGRENNE combina perfectamente con el conjunto de las gamas** para ofrecer un **servicio elegante y moderno.**



PLATEAUX EMPILABLES - STACKABLE SERVING TRAYS - APILABLES BANDEJAS



185018 ✱ 186458 ✱
238953(2) ✱ 238963(2) ✱
PLATEAU RECTANGULAIRE AVEC ANSES
RECTANGULAR SERVING TRAYS WITH HANDLES
BANDEJA RECTANGULAR CON ASAS
EXT : 77 X 55 CM - 30 IN^{5/16} X 21 IN^{5/8}
INT : 68,5 X 46,5 CM - 26 IN^{15/16} X 18 IN^{5/16}

185023 ✱ 186459 ✱
238954(2) ✱ 238964(2) ✱
PLATEAU RECTANGULAIRE AVEC ANSES GASTRONORM 2/1
RECTANGULAR SERVING TRAYS WITH HANDLES
BANDEJA RECTANGULAR CON ASAS
EXT : 65 X 53 CM - 25 IN^{9/16} X 20 IN^{7/8}
INT : 56,5 X 44,5 CM - 22 IN^{1/4} X 17 IN^{1/2}

185022 ✱ 186460 ✱
238955(2) ✱ 238965(2) ✱
PLATEAU RECTANGULAIRE AVEC ANSES
RECTANGULAR SERVING TRAYS WITH HANDLES
BANDEJA RECTANGULAR CON ASAS
EXT : 60 X 40 CM - 23 IN^{5/8} X 15 IN^{3/4}
INT : 51,5 X 31,5 CM - 20 IN^{1/4} X 12 IN^{3/8}



185021 ✱ 186461 ✱
238962(1) ✱ 238972(1) ✱
PLATEAU RECTANGULAIRE SANS ANSES GASTRONORM 1/1
RECTANGULAR SERVING TRAYS WITHOUT HANDLES
BANDEJA RECTANGULAR SIN ASAS
EXT : 53 X 32,5 CM - 20 IN^{7/8} X 12 IN^{13/16}
INT : 46,5 X 26 CM - 18 IN^{5/16} X 10 IN^{1/4}



185020 ✱ 186462 ✱
238961(1) ✱ 238971(1) ✱
PLATEAU RECTANGULAIRE SANS ANSES
RECTANGULAR SERVING TRAYS WITHOUT HANDLES
BANDEJA RECTANGULAR SIN ASAS
EXT : 40 X 27 CM - 15 IN^{3/4} X 10 IN^{5/8}
INT : 33,5 X 20,5 CM - 13 IN^{3/16} X 8 IN^{1/16}



185019 ✱ 186463 ✱
238960(1) ✱ 238970(1) ✱
PLATEAU RECTANGULAIRE SANS ANSES GASTRONORM 1/2
RECTANGULAR SERVING TRAYS WITHOUT HANDLES
BANDEJA RECTANGULAR SIN ASAS
EXT : 32,5 X 26,5 CM - 12 IN^{13/16} X 10 IN^{7/16}
INT : 26 X 20 CM - 10 IN^{1/4} X 7 IN^{7/8}



227767 ✱ 227768 ✱
PLATEAU RECTANGULAIRE SANS ANSES
RECTANGULAR SERVING TRAYS WITHOUT HANDLES
BANDEJA RECTANGULAR SIN ASAS
EXT : 22 X 14 CM - 8 IN^{11/16} X 5 IN^{1/2}
INT : 20 X 12 CM - 7 IN^{7/8} X 4 IN^{3/4}



185024 ✱ 186457 ✱
PLATEAU ROND
ROUND TRAY
BANDEJA REDONDA
INT : 42 CM - 16 IN^{9/16}
EXT : 35,1 CM - 13 IN^{13/16}



232972 ✱
PLATEAU RECTANGULAIRE
RECTANGULAR SERVING TRAY
BANDEJA RECTANGULAR
INT : 26 X 18 CM - 10 IN^{1/4} X 7 IN^{1/16}
EXT : 23 X 15 CM - 9 IN^{1/16} X 5 IN^{7/8}

(1) Nouveaux codes à partir du 01/04/2020
New codes valid from 2020/04/01
Nuevos códigos a partir de 01/04/2020

(2) Nouveaux codes à partir du 01/07/2020
New codes valid from 2020/07/01
Nuevos códigos a partir de 01/07/2020



NEWPORT



PLATEAUX EMPILABLES - STACKABLE SERVING TRAYS
APILABLES BANDEJAS

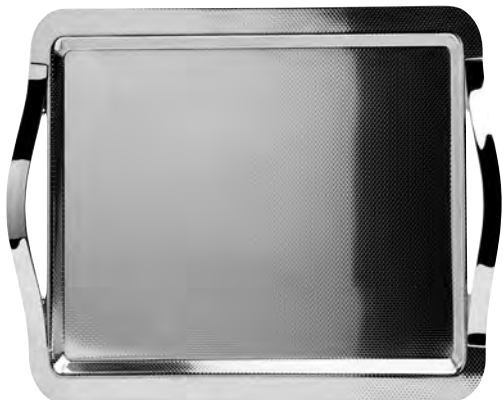

211886 213857
 238987(1) 238989(1)
PLATEAU RECTANGULAIRE AVEC ANSES GASTRONORM 2/1
 RECTANGULAR SERVING TRAYS WITH HANDLES
 BANDEJA RECTANGULAR CON ASAS
 EXT : 65 X 53 CM - 25 IN^{9/16} X 20 IN^{7/8}
 INT : 56,5 X 44,5 CM - 22 IN^{1/4} X 17 IN^{1/2}



211887 213858
 238988(1) 238990(1)
PLATEAU RECTANGULAIRE AVEC ANSES
 RECTANGULAR SERVING TRAYS WITH HANDLES
 BANDEJA RECTANGULAR CON ASAS
 EXT : 60 X 40 CM - 23 IN^{5/8} X 15 IN^{3/4}
 INT : 51,5 X 31,5 CM - 20 IN^{1/4} X 12 IN^{3/8}



211888 213859
PLATEAU RECTANGULAIRE SANS ANSES GASTRONORM 1/2
 RECTANGULAR SERVING TRAYS WITHOUT HANDLES
 BANDEJA RECTANGULAR SIN ASAS
 EXT : 32,5 X 26,5 CM - 12 IN^{13/16} X 10 IN^{7/16}
 INT : 26 X 20 CM - 10 IN^{1/4} X 7 IN^{7/8}



211889 213860
PLATEAU RECTANGULAIRE SANS ANSES
 RECTANGULAR SERVING TRAYS WITHOUT HANDLES
 BANDEJA RECTANGULAR SIN ASAS
 EXT : 22 X 14 CM - 8 IN^{11/16} X 5 IN^{1/2}
 INT : 20 X 12 CM - 7 IN^{7/8} X 4 IN^{3/4}



230872 230874
DESSOUS DE BOUTEILLE
 BOTTLE COASTER
 POSABOTELLA
 13,5 CM - 5 IN^{5/16}

(1) Nouveaux codes à partir du 01/06/2020
 New codes valid from 2020/06/01
 Nuevos códigos a partir de 01/06/2020



©Julie ANSIAU

L'abus d'alcool est dangereux pour la santé.
 Degreem promoties responsible drinking and discourages alcohol misuse.
 El abuso de alcohol es peligroso para la salud.



NEWPORT CUBIQUE





183019 ✱ 186451 ✱
238958(1) ✱ 238968(1) ✱
PLAT OVALE
OVAL DISH
FUENTE OVALADA
EXT : 46 X 31 CM - 18 IN^{1/8} X 12 IN^{3/16}
INT : 25,9 X 13,9 CM - 10 IN^{3/16} X 5 IN^{1/2}



183018 ✱ 186450 ✱
238957(1) ✱ 238967(1) ✱
PLAT OVALE
OVAL DISH
FUENTE OVALADA
EXT : 41 X 28 CM - 16 IN^{1/8} X 11 IN
INT : 28,7 X 15,6 CM - 11 IN^{5/16} X 6 IN^{1/8}



183017 ✱ 186449 ✱
238956(1) ✱ 238966(1) ✱
PLAT OVALE
OVAL DISH
FUENTE OVALADA
EXT : 38 X 25 CM - 14 IN^{15/16} X 9 IN^{13/16}
INT : 26,6 X 16,3 CM - 10 IN^{1/2} X 6 IN^{7/16}



220120 ✱ 220121 ✱
PLAT ROND CREUX
ROUND DEEP DISH
BANDEJA REDONDA
EXT : 33,5 CM - 13 IN^{3/16}
INT : 20 CM - 7 IN^{7/8}



183021 ✱ 186453 ✱
238959(1) ✱ 238969(1) ✱
PLAT À POISSON
FISH DISH
FUENTE PARA PESCADO
EXT : 60 X 27 CM - 23 IN^{5/8} X 10 IN^{5/8}
INT : 46,3 X 14,3 CM - 18 IN^{1/4} X 5 IN^{5/8}



186198 ✱ 186456 ✱
SAUCIÈRE
SAUCE BOAT
SALSERA
19 X 7,6 CM - 7 IN^{1/2} X 3 IN
20 CL - 6 OZ^{3/4}



185307 ✱ 186455 ✱
BEURRIER
BUTTER DISH
MANTEQUILLERA INDIV.
Ø 7,6 X 7 CM
Ø 3 IN X 2 IN^{3/4}



190255
**SOCLE BEURRIER
PORCELAINE**
BUTTER DISH BASE PORCELAINE
MANTEQUILLERA SIN TAPA
Ø 9 X 7,6 CM
Ø 3 IN X 2 IN^{3/4}



211397 ✱
**PORTE SUCRE
CENTRE DE TABLE**
SUGAR HOLDER/TABLE
CENTERPIECE
CENTRO DE MESA
Ø 6,4 X H 6 CM
Ø 2 IN^{1/2} X H 2 IN^{3/8}



208862 ✱
**PORTE SUCRE
CENTRE DE TABLE**
SUGAR HOLDER/TABLE
CENTERPIECE
CENTRO DE MESA
Ø 5 X H 6 CM
Ø 1 IN^{5/16} X H 2 IN^{3/8}

(1) Nouveaux codes à partir du 01/04/2020
New codes valid from 2020/04/01
Nuevos códigos a partir de 01/04/2020



NEWPORT



CAFÉTERIE - COFFEEWARE - CAFETERA



213850 ✱ 219563
VERSEUSE
 COFFEE/TEA POT
 CAFETERA/TETERA
 1,5 L - 50 OZ^{3/4}
 18,1 CM X H 22,4 CM
 7 IN^{1/8} X H 8 IN^{13/16}



213851 ✱ 219564
VERSEUSE
 COFFEE/TEA POT
 CAFETERA/TETERA
 70 CL - 23 OZ^{1/16}
 14,8 CM X H 14,6 CM
 5 IN^{13/16} X H 5 IN^{3/4}



213852 ✱ 219565
VERSEUSE
 COFFEE/TEA POT
 CAFETERA/TETERA
 35 CL - 11 OZ^{13/16}
 12,9 CM X H 9,3 CM
 5 IN^{1/16} X H 3 IN^{11/16}



213849 ✱ 219561
PICHET
 JUG
 JARRA
 2 L - 67 OZ^{5/8}
 18,1 CM X H 23 CM
 7 IN^{1/8} X H 9 IN^{1/16}

POT ISOTHERME - INSULATED POT - JARRA ISOTÉRMICA



213846 ✱ 219557
POT ISOTHERME
 INSULATED POT
 JARRA ISOTÉRMICA
 1,2 L - 40 OZ^{9/16}
 18,1 CM X H 22,7 CM
 7 IN^{1/8} X H 8 IN^{15/16}



213847 ✱ 219558
POT ISOTHERME
 INSULATED POT
 JARRA ISOTÉRMICA
 70 CL - 23 OZ^{1/3}
 15,6 CM X H 19,2 CM
 6 IN^{1/8} X H 7 IN^{9/16}



213848 ✱ 219559
POT ISOTHERME
 INSULATED POT
 JARRA ISOTÉRMICA
 30 CL - 40 OZ
 13,4 CM X H 12,7 CM
 5 IN^{1/4} X H 5 IN



213853 ✱ 219566
CRÉMIER
 CREAM JUG
 LECHERA
 35 CL - 11 OZ^{13/16}
 12,9 CM X H 9 CM
 5 IN^{1/16} X H 3 IN^{9/16}



213854 ✱ 219567
CRÉMIER
 CREAM JUG
 LECHERA
 15 CL - 5 OZ^{1/16}
 9 CM X H 9 CM
 3 IN^{9/16} X H 3 IN^{9/16}



182341 ✱ 184612
SUCRIER
 SUGAR BOWL
 AZUCARERO
 35 CL - 11 OZ^{13/16}



002191 ✱ 129797
PINCE À SUCRE
 SUGAR TONG
 PINZAS PARA AZÚCAR
 11,5 CM - 4 IN^{1/2}



NEWPORT





184180 ✱ 188895 ✱
**SEAU À CHAMPAGNE
 2 BOUTEILLES**
 CHAMPAGNE BUCKET 2 BOTTLES
 CHAMPANERA 2 BOTELLAS
 Ø 24 X H 25,5 CM
 Ø 9 IN^{7/16} X H 10 IN^{1/16}



186030 ✱ 188894 ✱
**SEAU À CHAMPAGNE
 1 BOUTEILLE**
 CHAMPAGNE BUCKET 1 BOTTLE
 CHAMPANERA 1 BOTELLA
 Ø 20 X H 22,5 CM
 Ø 7 IN^{7/8} X H 8 IN^{7/8}



184181 ✱ 188896 ✱
**SEAU À GLACE
 AVEC COUVERCLE**
 ICE BUCKET WITH LID
 CUBITERA CON TAPA
 Ø 15 X H 16 CM
 Ø 5 IN^{7/8} X H 6 IN^{5/16}



NEW
 237501 ✱
RAFRAICHISSEUR DROIT DOUBLE PAROI
 CURVED DOUBLE WALL WINE COOLER
 ENFRIADOR DE BOTELLA DOBLE PARED
 Ø 13,9 X H 19,8 CM
 Ø 5 IN^{7/8} X H 7 IN^{3/16}



004014
PINCE À GLACE
 ICE TONG
 PINZA PARA HIELO
 16 CM - 6 IN^{5/16}



234320 ✱
DESSOUS DE BOUTEILLE
 BOTTLE COASTER
 POSABOTELLA
 9,5 CM - 3 IN^{3/4}



185607 ✱ 188893 ✱
**PORTE SEAU À CHAMPAGNE
 (1 OU 2 BOUTEILLES)**
 CHAMPAGNE BUCKET STAND
 (1 OR 2 BOTTLES)
 PORTACUBO (1/2 BOTELLAS)
 H 63,5 CM - 25 IN



216919 ✱
VERRINE SEL AIMANTÉE
 SALT CELLAR W/MAGNET
 SALERO CON IMÁN
 4,1 X 6,7 CM
 1 IN^{5/8} X 2 IN^{5/8}



216920 ✱
VERRINE POIVRE AIMANTÉE
 PEPPER CELLAR W/MAGNET
 PIMENTERO CON IMÁN
 4,1 X 6,7 CM
 1 IN^{5/8} X 2 IN^{5/8}



216922 ✱
ENSEMBLE SEL & POIVRE AIMANTÉ
 SALT & PEPPER CELLAR W/MAGNET
 CONJUNTO SALERO/PIMENTERO CON IMÁN
 8,5 X 10,6 CM - 3 IN^{3/8} X 4 IN^{3/16}

L'alcool est dangereux pour la santé.
 De ne pas boire avec excès. Le non-développement de l'alcoolisme.
 El abuso de alcohol es peligroso para la salud.



Finedining

NEWPORT



EMPILABLES - STACKABLE - APILABLES



182614 ✱ 184477
CLOCHE ASSIETTE
DOME COVER, STAINLESS STEEL,
CAMPANA
Ø 24 CM - 9 IN^{7/16}

182301 ✱ 184476
CLOCHE ASSIETTE
DOME COVER, STAINLESS STEEL
CAMPANA
Ø 14,8 CM - 5 IN^{13/16}



044113 ✱ 101512
CLOCHE ASSIETTE
DOME COVER, STAINLESS STEEL
CAMPANA
Ø 26 CM - 10 IN^{1/4}

044112 ✱ 101510
CLOCHE ASSIETTE
DOME COVER, STAINLESS STEEL
CAMPANA
Ø 22 CM - 8 IN^{7/8}



206504
BOUCHON PORCELAIN POUR CLOCHE VERRE
PORCELAIN LID FOR GLASS DOME
COVER
TAPA DE PORCELANA PARA
CAMPANA DE VIDRIO
5,2 CM - 2 IN^{1/16}



120522 ✱ 131115
CORBEILLE À PAIN RONDE EN FIL
ROUND BREAD BASKET
PANERA REDONDA
Ø 20,5 X H 7,5 CM
Ø 8 IN^{1/16} X H 2 IN^{15/16}

128910 ✱ 131114
CORBEILLE À PAIN RONDE EN FIL
ROUND BREAD BASKET
PANERA REDONDA
Ø 17,5 X H 6 CM
Ø 6 IN^{7/8} X H 2 IN^{3/8}

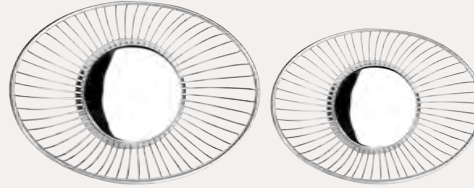

128912 ✱ 131117
CORBEILLE À PAIN OVALE EN FIL
OVAL BREAD BASKET
PANERA OVALADA
Ø 24 X 17 CM - H 7,5 CM
Ø 9 IN^{7/16} X 6 IN^{11/16} - H 2 IN^{15/16}

128911 ✱ 131118
CORBEILLE À PAIN OVALE EN FIL
OVAL BREAD BASKET
PANERA OVALADA
Ø 20 X 15 CM - H 6 CM
Ø 7 IN^{7/8} X 5 IN^{7/8} - H 2 IN^{3/8}

204043
CLOCHE VERRE BOROSILICATE
GLASS DOME COVER
CAMPANA VIDRIO BOROSILICATO
17X9 CM - 6 IN^{1/16} X 3 IN^{9/16}



164138
PLAT À ESCARGOTS
SNAIL TRAY 6 SPACES
BANDEJA CARACOLAS 6
COMPARTIMENTOS
16,6 CM - 6 IN^{9/16}



168845 ✱
CUILLÈRE À SPAGHETTI
SPAGHETTI SERVING SPOON
CUCHARA PARA ESPAGUETIS
29 CM - 11 IN^{7/16}



168844 ✱
FOURCHETTE À VIANDE
MEAT FORK
TENEDOR DE CARNE
29 CM - 11 IN^{7/16}



159597 ✱ 101453
BOL RINCE DOIGTS
FINGER BOWL
LAVADEDOS
Ø 11 X H 4 CM
Ø 4 IN^{5/16} X H 1 IN^{9/16}



004013 ✱
PINCE À ESCARGOTS
SNAIL TONG
PINZAS CARACOLAS
16 CM - 6 IN^{5/16}



204497 ✱ 101493
PINCE À HOMARD
LOBSTER CRACKER
TENACILLAS PARA
BOGAVANTE
18,5 CM - 7 IN^{5/16}



184492 ✱
PINCE À CRUSTACÉ
SEAFOOD CRACKER
TENACILLAS PARA
CRUSTÁCEOS
16,5 CM - 6 IN^{1/2}



204496 ✱ 101494
CISEAUX À GÂTEAUX
PASTRY SCISSORS/TONG
PINZAS PARA SCISSORS
20 CM - 7 IN^{7/8}



204499 ✱ 184355
PINCE À SERVIR
SERVING TONG
PINZAS PARA SERVIR
29,5 CM - 11 IN^{5/8}



204498 ✱ 101492
PINCE À PAIN
BREAD TONG
PINZAS PAN
23 CM - 9 IN^{1/16}

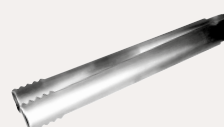

004014 ✱
PINCE À GLACE
ICE TONG
PINZAS PARA HIELO
16 CM - 6 IN^{5/16}



002191 ✱ 129797
PINCE À SUCRE
SUGAR TONG
PINZA PARA AZÚCAR
11,5 CM - 4 IN^{1/2}



130994 ✱
CUILLÈRE À TOASTS
APPETIZER SPOON
CUCHARA APERITIVO
11,8 CM - 7 IN^{7/16}

NEWPORT







VERRES

Les collections de verres DEGRENNE invitent au partage et à la dégustation. Leurs qualités esthétiques ainsi que leur résistance exceptionnelle, garantissent une utilisation en toute occasion. Pour compléter harmonieusement la table, les verres de couleur DEGRENNE, teints dans la masse, offrent une esthétique et une qualité à l'épreuve du temps et des lavages au lave-vaisselle.

GLASSWARE

DEGRENNE'S glassware collections are an invitation to socialize and enjoy a drink. Our glassware's looks and exceptional sturdiness mean that it can be used at any occasion. DEGRENNE's integrally dyed glasses are a harmonious addition to the dining table and offer looks and quality that withstand the test of time and repeated washing in the dishwasher. Each hand-blown glass is unique!

CRISTALERÍA

Las colecciones de copas DEGRENNE invitan a compartir y a degustar. Sus cualidades estéticas así como su resistencia, excepcional, garantizan un uso en cualquier ocasión. Para completar la mesa con armonía, las copas de color DEGRENNE, pintadas en masa, ofrecen una estética y una calidad que supera el paso del tiempo y los lavados en el lavavajillas. Soplada en boca de manera artesanal, ¡cada pieza es única !

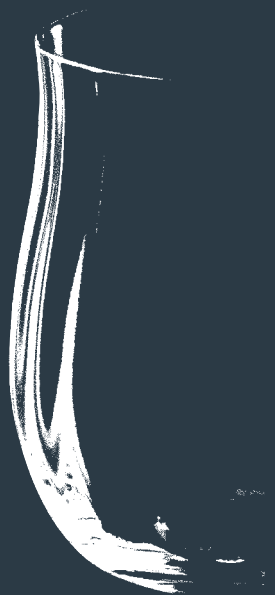

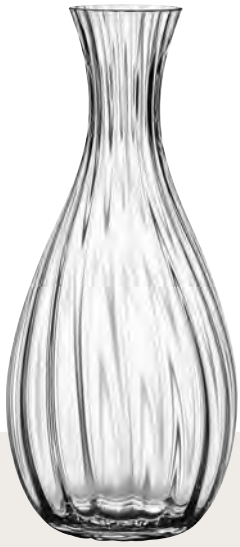

236752
CARAFE
CARAFE
BOTELLA
1,1 L - 37 OZ^{3/16}
Ø 5,2 X H 25,3 CM
Ø 2 IN^{1/16} X H 9 IN^{15/16}



234102
FLÛTE À CHAMPAGNE
CHAMPAGNE FLÛTE
FLAUTA CHAMPÁN
13 CL - 4 OZ^{3/8}
Ø 5 X H 21,7 CM
Ø 1 IN^{15/16} X H 8 IN^{9/16}



234104
VERRE À VIN BLANC
WHITE WINE GLASS
COPA DE VINO BLANCO
25 CL - 8 OZ^{7/16}
Ø 7 X H 20 CM
Ø 2 IN^{3/4} X H 8 IN^{1/4}



234103
VERRE À VIN ROUGE
RED WINE GLASS
COPA DE VINO TINTO
40 CL - 13 OZ^{1/2}
Ø 8,3 X H 21,7 CM
Ø 3 IN^{1/4} X H 8 IN^{9/16}



184561
VERRE À EAU À PIED
STEMMED GLASS
COPA DE AGUA
25 CL - 8 OZ^{7/16}
Ø 7,3 X H 12 CM
Ø 2 IN^{7/8} X H 4 IN^{3/4}



234106
GOBELET BAS
LOW TUMBLER
VASO BAJO
33 CL - 11 OZ^{3/16}
Ø 7,9 X H 9,5 CM
Ø 3 IN^{1/8} X H 3 IN^{3/4}



NEW HÉRITAGE





184584
FLÛTE À CHAMPAGNE
CHAMPAGNE FLUTE
FLAUTA CHAMPÁN
27 CL - 9 OZ^{1/8}
Ø 8 X H 24,3 CM
Ø 3 IN^{1/8} X H 9 IN^{3/16}



184583
VERRE À VIN BLANC
WHITE WINE GLASS
COPA DE VINO BLANCO
35 CL - 11 OZ^{13/16}
Ø 8 X H 22,3 CM
Ø 3 IN^{1/8} X H 8 IN^{3/4}



184582
VERRE À VIN ROUGE
RED WINE GLASS
COPA DE VINO TINTO
42 CL - 14 OZ^{3/16}
Ø 8,3 X H 23,1 CM
Ø 3 IN^{1/4} X H 9 IN^{1/8}



184581
VERRE À EAU
WATER GLASS
COPA DE AGUA
48 CL - 16 OZ^{1/4}
Ø 8,9 X H 23,5 CM
Ø 3 IN^{1/2} X H 9 IN^{1/4}



DANDY





184551
FLÛTE À CHAMPAGNE
CHAMPAGNE FLUTE
FLAUTA CHAMPÁN
19 CL - 6 OZ^{2/16}
Ø 6,3 X H 22,4 CM
Ø 2 IN^{1/2} X H 8 IN^{13/16}



184549
VERRE À VIN BLANC
WHITE WINE GLASS
COPA DE VINO BLANCO
28 CL - 9 OZ^{2/16}
Ø 7,4 X H 20,8 CM
Ø 2 IN^{15/16} X H 8 IN^{3/16}



184548
VERRE À VIN ROUGE
RED WINE GLASS
COPA DE VINO TINTO
35 CL - 11 OZ^{3/16}
Ø 8 X H 21,4 CM
Ø 3 IN^{1/8} X H 8 IN^{7/16}



184547
VERRE À EAU
WATER GLASS
COPA DE AGUA
45 CL - 15 OZ^{3/16}
Ø 8,4 X H 22,5 CM
Ø 3 IN^{5/16} X H 8 IN^{1/16}



184550
VERRE À BORDEAUX
BORDEAUX GLASS
COPA DE CAVA
64,5 CL - 21 OZ^{3/16}
Ø 9,5 X H 23,8 CM
Ø 3 IN^{3/4} X H 9 IN^{3/8}



210812
VERRE À BOURGOGNE
BURGUNDY GLASS
COPA BOURGOGNE
70 CL - 23 OZ^{1/16}
Ø 10,5 X H 23,1 CM
Ø 4 IN^{1/8} X H 9 IN^{1/8}



184555
GOBELET HAUT
HIGH TUMBLER
VASO ALTO
36 CL - 12 OZ^{3/16}
Ø 6,8 X H 14,2 CM
Ø 2 IN^{11/16} X H 5 IN^{9/16}



184554
GOBELET BAS
LOW TUMBLER
VASO BAJO
33 CL - 11 OZ^{3/16}
Ø 8 X H 10,2 CM
Ø 3 IN^{1/8} X H 4 IN



184553
GOBELET BAS
LOW TUMBLER
VASO BAJO
23 CL - 7 OZ^{3/4}
Ø 7,6 X H 9,2 CM
Ø 3 IN X H 3 IN^{5/8}



184552
GOBELET BAS/VERRINE
LOW TUMBLER/APPETIZER GLASS
VASO BAJO/VASITOS
15 CL - 5 OZ^{1/16}
Ø 6,4 X H 8 CM
Ø 2 IN^{1/2} X H 3 IN^{1/8}







184556
FLÛTE À CHAMPAGNE
CHAMPAGNE FLUTE
FLAUTA CHAMPÁN
20 CL - 6 OZ^{3/4}
Ø 6,7 X H 21,2 CM
Ø 2 IN^{5/8} X H 8 IN^{3/8}



190537
VERRE À VIN
WINE GLASS
COPA DE VINO
35 CL - 11 OZ^{3/16}
Ø 7,8 X H 19,6 CM
Ø 3 IN^{1/16} X H 7 IN^{1/16}



190536
VERRE À EAU
WATER GLASS
COPA DE AGUA
45 CL - 15 OZ^{3/16}
Ø 8,4 X H 20,5 CM
Ø 3 IN^{5/16} X H 8 IN^{1/16}



190538
GOBELET
TUMBLER
VASO
47 CL - 15 OZ^{2/8}
Ø 8,5 X H 12,1 CM
Ø 3 IN^{3/8} X H 4 IN^{3/4}



DÉCOR TAILLÉ DANS LE VERRE
CUT-GLASS DESIGN
DECORACIÓN TALLADA EN CRISTAL



GALATÉE



À CHAQUE VERRE SON VIN - A GLASS FOR EACH AND EVERY WINE - UN VASO PARA CADA VINO



DEGRENNE S'EST ASSOCIÉ À **MANUEL PEYRONDET**, MEILLEUR OUVRIER DE FRANCE SOMMELIER 2013 POUR CRÉER **ORIGINE**, LA PREMIÈRE GAMME DE 5 VERRES À PIED PERMETTANT D'ASSOCIER DE MANIÈRE SIMPLE ET ÉVIDENTE UN VIN AVEC LE BON VERRE.

DEGRENNE HAS JOINED FORCES WITH **MANUEL PEYRONDET**, THE 2013 WINNER OF THE PRESTIGIOUS MEILLEUR OUVRIER DE FRANCE SOMMELIER AWARD, TO CREATE **ORIGINE**, THE FIRST RANGE OF FIVE STEMMED GLASSES, MAKING IT EASY TO CHOOSE THE RIGHT GLASS FOR YOUR WINE.

DEGRENNE SE HA ASOCIADO CON **MANUEL PEYRONDET**, EL MEJOR OBRADOR DE FRANCIA SUMILLER DE 2013 PARA CREAR **ORIGINE**, LA PRIMERA GAMA DE 5 COPAS DE VINO, QUE PERMITE ASOCIAR DE MANERA SENCILLA Y EVIDENTE UN VINO CON LA COPA ADECUADA.

N°1

CHAMPAGNE
PROSECCO



216733
EFFERVESCENCE
EFFERVESCENCE
ESPUMA
22,5 CL - 7 OZ^{5/8}
Ø 7,1 X H 21 CM
Ø 2 IN^{13/16} X H 8 IN^{1/4}

N°2

RIESLING, SAUVIGNON,
CHENIN, GAMAY,
CABERNET, FRANC



216730
FRAÎCHEUR
FRESHNESS
FRESCURA
50 CL - 16 OZ^{15/16}
Ø 8,9 X H 21,5 CM
Ø 3 IN^{1/2} X H 8 IN^{7/16}

N°3

GRENACHE, MERLOT,
MALBEC, SYRHA
CABERNET SAUVIGNON



216731
PUISSANCE
STRENGTH
POTENCIA
50 CL - 16 OZ^{15/16}
Ø 9,5 X H 21,5 CM
Ø 3 IN^{3/4} X H 8 IN^{7/16}

N°4

PINOT NOIR,
CHARDONNAY,
BOURGOGNE



216732
SUBTLITÉ
SUBTLETY
SUTILEZA
60 CL - 20 OZ^{5/16}
Ø 10,2 X H 21,5 CM
Ø 4 IN X H 8 IN^{7/16}

N°5

POUR LES VINS MOELLEUX ET LIQUEUREUX
FOR SWEET & SYRUPY WINES
PARA LOS VINOS MELOSOS
Y LICOROSOS



216734
DOUCEUR
SWEETNESS
DULZOR
20 CL - 6 OZ^{3/4}
Ø 6,9 X H 20 CM
Ø 2 IN^{11/16} X H 7 IN^{7/8}

OUVERTURE DU BUVANT
THE OPENING OF THE RIM
LA APERTURA DE LA BOCA



**POUR AFFIRMER
LA TEXTURE DU VIN**
AFFIRM THE WINE'S
TEXTURE
PARA AFIRMAR
LA TEXTURA DEL VINO

HAUTEUR DE PARISSON
THE HEIGHT OF THE BULB
LA ALTURA DEL FONDO



**POUR JOUER SUR
L'EXPANSION DES BOUQUETS**
ALLOW THE BOUQUETS TO
FLOURISH
PARA JUGAR SOBRE LA
AMPLIACIÓN DE LOS BUQUÉS

DIAMÈTRE DE PARISSON
THE DIAMETER OF THE BULB
EL DIÁMETRO DEL FONDO

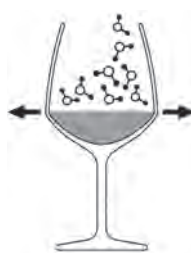

**POUR LAISSER LE VIN
S'OXYGÉNER**
ALLOW THE WINE TO
AERATE
PARA DEJAR QUE EL VINO
OXIGENE

3 LEVIERS ONT ÉTÉ IDENTIFIÉS
3 KEY FACTORS WERE IDENTIFIED
SE HAN IDENTIFICADO 3 PARÁMETROS

HAUTEUR COMPATIBLE LAVE-VAISSELLE
DISHWASHER COMPATIBLE HEIGHT
ALTURA COMPATIBLE CON LAVA-VAJILLAS

SERVICE FACILITÉ PAR LA JAUGE NATURELLE DE 12 CL
SERVICE IS FACILITATED BY THE 12 CL MARKING
SERVICIO FACILITADO POR EL INDICADOR DE NIVEL NATURAL DE 12 CL



@Julie ANSIAU

L'alcool est dangereux pour la santé.
Dégrenerne promouvent responsable drinking and discourages alcohol misuse.
El alcohol es dañino para la salud.

ORIGINE





184566
FLÛTE À CHAMPAGNE
CHAMPAGNE FLUTE
FLAUTA CHAMPÁN
19 CL - 6 OZ^{2/16}
Ø 5,3 X H 21,9 CM
Ø 2 IN^{1/16} X H 8 IN^{5/8}



184563
VERRE À VIN BLANC
WHITE WINE GLASS
COPA DE VINO BLANCO
28 CL - 9 OZ^{2/16}
Ø 7,3 X H 21,2 CM
Ø 2 IN^{7/8} X H 8 IN^{3/8}



184562
VERRE À VIN ROUGE
RED WINE GLASS
COPA DE VINO TINTO
37 CL - 12 OZ^{1/2}
Ø 7,7 X H 21,4 CM
Ø 3 IN^{1/16} X H 8 IN^{7/16}



184561
VERRE À EAU
WATER GLASS
COPA DE AGUA
49,5 CL - 16 OZ^{3/4}
Ø 8,6 X H 22,7 CM
Ø 3 IN^{3/8} X H 8 IN^{15/16}



184564
VERRE À BORDEAUX
BORDEAUX GLASS
COPA DE CAVA
65 CL - 22 OZ
Ø 9,4 X H 23,9 CM
Ø 3 IN^{11/16} X H 9 IN^{7/16}



184565
VERRE À BOURGOGNE
BURGUNDY GLASS
COPA BOURGOGNE
75 CL - 25 OZ^{3/8}
Ø 10,7 X H 22,5 CM
Ø 4 IN^{3/16} X H 8 IN^{7/8}



DOMAINE





184580
FLÛTE À CHAMPAGNE
CHAMPAGNE FLÛTE
FLAUTA CHAMPÁN
21 CL - 7 OZ^{1/8}
Ø 7 X H 21 CM
Ø 2 IN^{3/4} X H 8 IN^{1/4}



184578
VERRE À VIN
WINE GLASS
COPA DE VINO
20 CL - 6 OZ^{3/4}
Ø 7 X H 17,4 CM
Ø 2 IN^{3/4} X H 6 IN^{7/8}



184577
VERRE À VIN BLANC
WHITE WINE GLASS
COPA DE VINO BLANCO
25 CL - 8 OZ^{2/16}
Ø 7,5 X H 18,4 CM
Ø 2 IN^{5/16} X H 7 IN^{1/4}



184576
VERRE À VIN ROUGE
RED WINE GLASS
COPA DE VINO TINTO
32 CL - 10 OZ^{13/16}
Ø 7,8 X H 19,8 CM
Ø 3 IN^{1/16} X H 7 IN^{13/16}



184575
VERRE À EAU
WATER GLASS
COPA DE AGUA
42 CL - 14 OZ^{3/16}
Ø 8,7 X H 20,5 CM
Ø 3 IN^{7/16} X H 8 IN^{1/16}



184579
VERRE À BOURGOGNE
BURGUNDY GLASS
COPA BOURGOGNE
58 CL - 19 OZ^{5/8}
Ø 10 X H 20 CM
Ø 3 IN^{15/16} X H 7 IN^{7/8}

**MONTMARTRE
JAUGÉ**



• 14 CL - 4 oz^{3/4}
• 12,5 CL - 4 oz^{1/4}

208481
**VERRE À VIN ROUGE
AVEC DOUBLE JAUGE**
RED WINE GLASS WITH 2 GAUGES
COPA DE VINO TINTO
CON DOBLE INDICATOR
32 CL - 10 OZ^{13/16}
Ø 7,8 X H 19,8 CM
Ø 3 IN^{1/16} X H 7 IN^{13/16}

**HYPNOTIC
JAUGÉ**



213816
**VERRE À VIN
AVEC DOUBLE JAUGE**
RED WINE GLASS WITH 2 GAUGES
COPA DE VINO TINTO
CON DOBLE INDICATOR
36,5 CL - 13 OZ
Ø 8,2 X H 22 CM
Ø 3 IN^{1/4} X H 8 IN^{17/16}



AVEC DOUBLE JAUGE
WITH 2 GAUGE
CON DOBLE INDICATOR
14 CL - 4 oz^{3/4}
12,5 CL - 4 oz^{1/4}



©Sébastien D'Halleux
L'abus d'alcool est dangereux pour la santé.
Dígame promesas responsables drinking and discourages alcohol misuse.
El abuso de alcohol es peligroso para la salud.

All day dining

MONTMARTRE





NEW
 236288
CARAFE
 PITCHER
 BOTELLA
 75 CL - 25 OZ^{3/8}
 Ø 9,1 X H 24 CM
 Ø 3 IN^{9/16} X H 4 IN^{3/8}



NEW
 236287
VERRE À PIED
 STEMMED GLASS
 COPA
 26 CL - 8 OZ^{3/4}
 Ø 7,9 X H 11,1 CM
 Ø 3 IN^{1/8} X H 4 IN^{3/8}



NEW
 236289
GOBELET
 TUMBLER
 VASO
 26 CL - 8 OZ^{3/4}
 Ø 7,1 X H 9,1 CM
 Ø 2 IN^{13/16} X H 3 IN^{9/16}



VERRES EMPILABLES
 STACKABLE GLASSES
 VASOS APILABLES



234148
CARAFE
 PITCHER
 BOTELLA
 75 CL - 25 OZ^{3/8}
 Ø 9,1 X H 24 CM
 Ø 3 IN^{9/16} X H 4 IN^{3/8}



234149
VERRE À PIED
 STEMMED GLASS
 COPA
 26 CL - 8 OZ^{3/4}
 Ø 7,9 X H 11,1 CM
 Ø 3 IN^{1/8} X H 4 IN^{3/8}



234150
GOBELET
 TUMBLER
 VASO
 26 CL - 8 OZ^{3/4}
 Ø 7,1 X H 9,1 CM
 Ø 2 IN^{13/16} X H 3 IN^{9/16}



234151
VERRE À TAPAS
 TAPAS GLASS
 VASO DE TAPAS
 17 CL - 5 OZ^{3/4}
 Ø 7,9 X H 6,3 CM
 Ø 3 IN^{1/8} X H 2 IN^{1/2}



© Patrick ROUGEREAU
 Librai, alcool et de... pour la santé
 Degrème promotes responsible drinking and discourages alcohol misuse.
 El abuso de alcohol es peligroso para la salud.

EMPILEÓ





169728
DECANTEUR MILLÉSIME
 DECANTER
 DECANTADOR
 1,35 L - 45 OZ^{5/8}
 Ø 20,5 X H 23,5 CM
 Ø 8 IN^{1/16} X H 9 IN^{1/4}



188969
DECANTEUR VINDÉMIA
 DECANTER
 DECANTADOR
 1,35 L - 45 OZ^{5/8}
 Ø 23 X H 24 CM
 Ø 9 IN^{1/16} X H 9 IN^{7/16}



210904
DECANTEUR NECTAR
 DECANTER
 DECANTADOR
 1 L - 33 OZ^{13/16}
 Ø 13,5 X H 24,5 CM
 Ø 5 IN^{5/16} X H 9 IN^{5/8}



199027
CARAFE À WHISKY ANYTIME
 WHISKY CARAFE
 JARRA DE WHISKY
 1,2 L - 40 OZ^{3/16}
 Ø 9,5 X H 26 CM
 Ø 3 IN^{3/4} X H 10 IN^{1/4}



NEW
 236752
CARAFE HÉRITAGE
 CARAFE
 BOTELLA
 1,1 L - 37 OZ^{3/16}
 Ø 5,2 X H 25,3 CM
 Ø 2 IN^{1/16} X H 9 IN^{15/16}



202639
CARAFE À JUS DE FRUITS EVENTO
 JUICE/BEVERAGE CARAFE
 BOTELLA PARA ZUMOS
 1,2 L - 40 OZ^{3/16}
 Ø 10,5 X H 27,5 CM
 Ø 4 IN^{1/8} X H 10 IN^{3/16}



NEW
 236288
CARAFE EMPILEO
 PITCHER
 BOTELLA
 75 CL - 25 OZ^{3/8}
 Ø 9,1 X H 24 CM
 Ø 3 IN^{9/16} X H 4 IN^{3/8}



234148
CARAFE EMPILEO
 PITCHER
 BOTELLA
 75 CL - 25 OZ^{3/8}
 Ø 9,1 X H 24 CM
 Ø 3 IN^{9/16} X H 4 IN^{3/8}

202855
BOUCHON DE CARAFE SILICONE EVENTO
 SILICONE STOPPER
 FOR CARAFE
 TAPÓN PARA BOTELLA
 SILICONA
 Ø 6,5 CM - 2 IN^{9/16}

Leabus alcohol est dangereux pour la santé
 Degrime promotes responsible drinking and discourages alcohol misuse
 El abuso de alcohol es peligroso para la salud



CARAFES DÉCANTEURS



CHAMPAGNE - CHAMPÁN

BIÈRE - BEER - CERVEZA



184567
FLÛTE À CHAMPAGNE
CHAMPAGNE FLUTE
FLAUTA CHAMPÁN
15 CL - 5 OZ^{1/16}
Ø 6,3 X H 19,3 CM
Ø 2 IN^{1/2} X H 7 IN^{5/8}



184597
VERRE À CHAMPAGNE
CHAMPAGNE GLASS
FLAUTA CHAMPÁN
21 CL - 7 OZ^{1/8}
Ø 6,8 X H 20,5 CM
Ø 2 IN^{11/16} X H 8 IN^{1/16}



210281
COUPE À CHAMPAGNE
CHAMPAGNE GLASS
COPA CHAMPÁN
23 CL - 7 OZ^{3/4}
Ø 9,5 X H 14,7 CM
Ø 3 IN^{3/4} X H 5 IN^{13/16}



184569
VERRE À BIÈRE
BEER GLASS
VASO CERVEZA
39 CL - 13 OZ^{3/16}
Ø 7,3 X H 17,7 CM
Ø 2 IN^{7/8} X H 6 IN^{15/16}

COCKTAILS - COCTELES



195628
VERRE À MARTINI
MARTINI GLASS
COPA DE MARTINI
25 CL - 8 OZ^{7/16}
Ø 10,6 X H 16,8 CM
Ø 4 IN^{2/16} X H 6 IN^{5/8}



209814
VERRE À MARGARITA
MARGARITA GLASS
COPA DE MARGARITA
34 CL - 11 OZ^{1/2}
Ø 11,1 X H 17,2 CM
Ø 4 IN^{3/8} X H 6 IN^{3/4}



209815
VERRE À COCKTAIL
COCKTAIL GLASS
COPA COCKTAIL
48 CL - 16 OZ^{1/4}
Ø 8 X H 20,9 CM
Ø 3 IN^{1/8} X H 8 IN^{1/4}

DIGESTIF - LIQUEUR WINE - DIGESTIVOS



184570
VERRE À COGNAC
COGNAC GLASS
VASO COÑAC
61 CL - 20 OZ^{5/8}
Ø 10,4 X H 15,5 CM
Ø 4 IN^{1/8} X H 6 IN^{1/8}



190700
VERRE À PORTO/SHERRY
CHERRY GLASS
COPA JEREZ/OPORTO
10,4 CL - 3 OZ^{1/2}
Ø 5,6 X H 16,9 CM
Ø 2 IN^{3/16} X H 6 IN^{5/8}



209813
VERRE À SHOOTER
SHOT GLASS
COPA SHOOTER
4,5 CL - 1 OZ^{1/2}
Ø 4,6 X H 8 CM
Ø 1 IN^{13/16} X H 3 IN^{1/8}

VERRINES - APPETIZER GLASSES - VASITOS



181874
VERRINE RONDO
APPETIZER GLASS
VASITO
13 CL - 4 OZ^{1/8}
Ø 5,5 X H 6 CM
Ø 2 IN^{3/16} X H 2 IN^{3/8}



109439
COUPELLE BRAZIL
APPETIZER GLASS
VASO
30 CL - 10 OZ^{1/8}
Ø 13,2 X H 8,7 CM
Ø 5 IN^{3/16} X H 3 IN^{27/16}



210811
OSLO BOL SABLÉ
FROSTED BOWL
COPA/VASITO MATE
30 CL - 10 OZ^{1/8}



© Patrick ROUGERON
Lab. Rougeron, pour la santé.
Degrime, promettes responsables drinking and discourages alcohol misuse.
El abuso de alcohol es peligroso para la salud.

Alldaydining

ANYTIME





184555
GOBELET HAUT
 HIGH TUMBLER
 VASO ALTO
 36 CL - 12 OZ^{3/16}
 Ø 6,8 X H 14,2 CM
 Ø 2 IN^{11/16} X H 5 IN^{9/16}



184554
GOBELET BAS
 LOW TUMBLER
 VASO BAJO
 33 CL - 11 OZ^{3/16}
 Ø 8 X H 10,2 CM
 Ø 3 IN^{1/8} X H 4 IN



184553
GOBELET BAS
 LOW TUMBLER
 VASO BAJO
 23 CL - 7 OZ^{3/4}
 Ø 7,6 X H 9,2 CM
 Ø 3 IN X H 3 IN^{5/8}



184552
GOBELET BAS/VERRINE
 LOW TUMBLER/APPETIZER GLASS
 VASO BAJO/VASITOS
 15 CL - 5 OZ^{1/16}
 Ø 6,4 X H 8 CM
 Ø 2 IN^{1/2} X H 3 IN^{1/8}



184601
GOBELET HAUT
 HIGH TUMBLER
 VASO ALTO
 39 CL - 13 OZ^{3/16}
 Ø 6,6 X H 14,5 CM
 Ø 2 IN^{5/8} X H 5 IN^{11/16}



184600
GOBELET BAS
 LOW TUMBLER
 VASO BAJO
 35 CL - 11 OZ^{13/16}
 Ø 7,9 X H 9,1 CM
 Ø 3 IN^{1/8} X H 3 IN^{9/16}



184598
GOBELET BAS/VERRINE
 LOW TUMBLER/APPETIZER GLASS
 VASO BAJO/VASITOS
 19 CL - 6 OZ^{7/16}
 Ø 6,7 X H 8,1 CM
 Ø 2 IN^{5/8} X H 3 IN^{3/16}



184589
GOBELET HAUT
 HIGH TUMBLER
 VASO ALTO
 35 CL - 11 OZ^{13/16}
 Ø 6,5 X H 14,4 CM
 Ø 2 IN^{9/16} X H 5 IN^{11/16}



184588
GOBELET HAUT
 HIGH TUMBLER
 VASO ALTO
 29 CL - 9 OZ^{13/16}
 Ø 7 X H 10,7 CM
 Ø 2 IN^{3/4} X H 4 IN^{3/16}



189774
GOBELET BAS
 LOW TUMBLER
 VASO BAJO
 42 CL - 14 OZ^{3/16}
 Ø 8,5 X H 10,6 CM
 Ø 3 IN^{3/8} X H 4 IN^{3/16}



184586
GOBELET BAS
 LOW TUMBLER
 VASO BAJO
 32 CL - 10 OZ^{13/16}
 Ø 8 X H 9,4 CM
 Ø 3 IN^{1/8} X H 3 IN^{11/16}



© Patrick ROUGEREAU
 Librerie de la Gastronomie pour la santé
 Dégénère, promouvois responsable drinking and discourages alcohol misuse.
 El abuso de alcohol es peligroso para la salud.

Finedining

MUSE



Alldaydining

LOOP



Alldaydining

COSMOPOLITAIN





VERRES SOUFLÉS BOUCHE TEINTÉS DANS LA MASSE
HAND-BLOWN INTEGRALLY DYED GLASSES
VASOS SOPLADOS A BOCA, PINTADOS EN MASA



169851
**GOBELET HAUT
TRANSPARENT**
TRANSPARENT HIGH TUMBLER
VASO ALTO TRANSPARENT
57 CL - 19 OZ^{1/4}
Ø 6,7 X H 11,5 CM
Ø 2 IN^{5/8} X H 4 IN^{1/2}



169852
**GOBELET BAS
TRANSPARENT**
TRANSPARENT LOW TUMBLER
VASO BAJO TRANSPARENT
43 CL - 14 OZ^{2/16}
Ø 6,1 X H 10 CM
Ø 2 IN^{3/8} X H 3 IN^{15/16}



169856
**GOBELET BAS
GRIS**
GREY LOW TUMBLER
VASO BAJO GRIS
43 CL - 14 OZ^{2/16}
Ø 6,1 X H 10 CM
Ø 2 IN^{3/8} X H 3 IN^{15/16}



VERRES SOUFLÉS BOUCHE TEINTÉS DANS LA MASSE
HAND-BLOWN INTEGRALLY DYED GLASSES
VASOS SOPLADOS A BOCA, PINTADOS EN MASA



234489
**GOBELET
TRANSPARENT**
TRANSPARENT TUMBLER
VASO TRANSPARENT
40 CL - 13 OZ^{1/2}
Ø 8 X H 12,1 CM
Ø 3 IN^{1/8} X H 4 IN^{3/4}



206936
**GOBELET
TRANSPARENT**
TRANSPARENT TUMBLER
VASO TRANSPARENT
29 CL - 9 OZ^{13/16}
Ø 7,2 X H 9,5 CM
Ø 2 IN^{13/16} X H 3 IN^{3/4}



234491
**GOBELET
GRIS**
GREY TUMBLER
VASO GRIS
40 CL - 13 OZ^{1/2}
Ø 8 X H 12,1 CM
Ø 3 IN^{1/8} X H 4 IN^{3/4}



225517
**GOBELET
GRIS**
GREY TUMBLER
VASO GRIS
29 CL - 9 OZ^{13/16}
Ø 7,2 X H 9,5 CM
Ø 2 IN^{13/16} X H 3 IN^{3/4}



234490
**GOBELET
BLEU NUIT**
BLUE NIGHT TUMBLER
VASO AZUL
40 CL - 13 OZ^{1/2}
Ø 8 X H 12,1 CM
Ø 3 IN^{1/8} X H 4 IN^{3/4}



199461
**GOBELET
BLEU NUIT**
BLUE NIGHT TUMBLER
VASO AZUL
29 CL - 9 OZ^{13/16}
Ø 7,2 X H 9,5 CM
Ø 2 IN^{13/16} X H 3 IN^{3/4}



180939
**GOBELET
BLANC**
WHITE TUMBLER
VASO BLANCO
29 CL - 9 OZ^{13/16}
Ø 7,2 X H 9,5 CM
Ø 2 IN^{13/16} X H 3 IN^{3/4}



225516
**GOBELET
ROUGE**
RED TUMBLER
VASO ROJO
29 CL - 9 OZ^{13/16}
Ø 7,2 X H 9,5 CM
Ø 2 IN^{13/16} X H 3 IN^{3/4}



180936
**GOBELET
NOIR**
BLACK TUMBLER
VASO NEGRO
29 CL - 9 OZ^{13/16}
Ø 7,2 X H 9,5 CM
Ø 2 IN^{13/16} X H 3 IN^{3/4}



199462
**GOBELET
VERT POMME**
APPLE GREEN TUMBLER
VASO VERDE
29 CL - 9 OZ^{13/16}
Ø 7,2 X H 9,5 CM
Ø 2 IN^{13/16} X H 3 IN^{3/4}



174510
**GOBELET
CASSIS**
PURPLE TUMBLER
VASO PÚRPURA
29 CL - 9 OZ^{13/16}
Ø 7,2 X H 9,5 CM
Ø 2 IN^{13/16} X H 3 IN^{3/4}



© Sébastien D'Heuley
Labo de verres pour la santé
Dégremé, responsable drinking and discouragem alcohol misuse
El abuso de alcohol es peligroso para la salud

Finedining

DOLCE



Alldaydining

ALLEGRO





VERRES SOUFLÉS BOUCHE TEINTÉS DANS LA MASSE
HAND-BLOWN INTEGRALLY DYED GLASSES
VASOS SOPLADOS A BOCA, PINTADOS EN MASA



NEW
236340
VERRE À PIED
STEMMED GLASS
VASO BAJO
27 CL - 9 OZ^{1/8}
Ø 7,2 X H 11,5 CM
Ø 2 IN^{13/16} X H 4 IN^{1/2}



NEW
236338
GOBELET BAS
LOW TUMBLER
VASO BAJO
18 CL - 7 OZ^{1/16}
Ø 7,2 X H 6,5 CM
Ø 2 IN^{13/16} X H 2 IN^{9/16}



NEW
236339
GOBELET HAUT
HIGH TUMBLER
VASO ALTO
45 CL - 15 OZ^{3/16}
Ø 7,2 X H 14 CM
Ø 2 IN^{13/16} X H 5 IN^{1/2}



VERRES SOUFLÉS BOUCHE TEINTÉS DANS LA MASSE
HAND-BLOWN INTEGRALLY DYED GLASSES
VASOS SOPLADOS A BOCA, PINTADOS EN MASA



NEW
236988
GOBELET INCOLORE
TRANSPARENT TUMBLER
VASO TRANSPARENT
30 CL - 10 OZ^{1/8}
Ø 8,8 X H 8,8 CM
Ø 3 IN^{7/16} X H 3 IN^{7/16}



235133
GOBELET ARGILE VERTE
GREEN CLAY TUMBLER
VASO ARCILLA VERDE
30 CL - 10 OZ^{1/8}
Ø 8,8 X H 8,8 CM
Ø 3 IN^{7/16} X H 3 IN^{7/16}



230891
GOBELET GRIS
GREY TUMBLER
VASO GRIS
30 CL - 10 OZ^{1/8}
Ø 8,8 X H 8,8 CM
Ø 3 IN^{7/16} X H 3 IN^{7/16}



230890
GOBELET SABLE ROSE
PINK TUMBLER
VASO ROSE
30 CL - 10 OZ^{1/8}
Ø 8,8 X H 8,8 CM
Ø 3 IN^{7/16} X H 3 IN^{7/16}



230889
GOBELET BLEU DE ROCHE
BLUE TUMBLER
VASO AZUL
30 CL - 10 OZ^{1/8}
Ø 8,8 X H 8,8 CM
Ø 3 IN^{7/16} X H 3 IN^{7/16}



VERRES EMPILABLES
STACKABLE GLASSES
VASOS APILABLES



VERRES SOUFLÉS BOUCHE TEINTÉS DANS LA MASSE
HAND-BLOWN INTEGRALLY DYED GLASSES
VASOS SOPLADOS A BOCA, PINTADOS EN MASA



171631
GOBELET GRIS
GREY TUMBLER
VASO GRIS
34 CL - 11 OZ^{1/2}
Ø 8,5 X H 10 CM
Ø 3 IN^{3/8} X H 3 IN^{15/16}



171632
GOBELET VERT
GREEN TUMBLER
VASO VERDE
34 CL - 11 OZ^{1/2}
Ø 8,5 X H 10 CM
Ø 3 IN^{3/8} X H 3 IN^{15/16}



171633
GOBELET VIOLET
PURPLE TUMBLER
VASO VIOLETA
34 CL - 11 OZ^{1/2}
Ø 8,5 X H 10 CM
Ø 3 IN^{3/8} X H 3 IN^{15/16}



171630
GOBELET ROUGE
RED TUMBLER
VASO ROJO
34 CL - 11 OZ^{1/2}
Ø 8,5 X H 10 CM
Ø 3 IN^{3/8} X H 3 IN^{15/16}





Finedining

NEW ROC



Alldaydining

BILBAO



Alldaydining

MAMBO







LE BUFFET EVENTO

Du petit-déjeuner au dîner, des buffets sucrés aux buffets salés, la collection **EVENTO** répond à tous les scénarios de réception. Un design homogène, harmonieux, fonctionnel et modulable. La richesse de ses combinaisons et la diversité de ses matériaux (acier, porcelaine, verre, grès, mélamine pierre et bois etc...) s'adaptent à votre style et à la dimension de votre établissement. La collection **EVENTO** valorise avec une touche de chic la mise en scène de vos buffets, selon le moment de la journée, de la saison...

KITCHENWARE FOR YOUR BUFFET

From **breakfast to dinner**, from sweet buffets to savoury spreads, the **EVENTO** collection works for all your reception needs. A unified, harmonious, practical and modular design. With a host of combinations and a range of materials to choose from (steel, porcelain, glass, stoneware, melamine, stone and wood...), you can find what works for your style and the size of your space. The **EVENTO** collection adds a chic touch to your buffet presentations to reflect the time of day or the season.

CREACIÓN DE UN BUFÉ

La colección **EVENTO** resulta perfecta para cualquier recepción, tanto para bufés dulces como salados, del **desayuno a la cena**. Un diseño homogéneo, armonioso, funcional y modulable. La riqueza de sus combinaciones y la diversidad de sus materiales (acero, porcelana, cristal, gres, melamina de piedra y madera...) se amoldan a su estilo y a las dimensiones de su establecimiento. La colección **EVENTO** aporta un toque sofisticado para realzar la presentación de sus bufés según el momento del día, de la temporada.

EVENTO

PLATEAUX POUR MODULES FROIDS P.226
PLATTERS FOR REFRIGERATED UNITS - BANDEJAS PARA LOS MODULOS REFRIGERADOS

PLATEAUX ROUNDS P.234
ROUND TRAY - BANDEJA REDONDA

PLATEAUX GN 1/1 - 2/3 - 1/2 - 1/3 - MELAMINE PIERRE - MELAMINE BOIS P.226
TRAY - BANDEJA - STONE MELAMINE - WOOD MELAMINE
MELAMINA PIEDRA - MELAMINA MADERA



CHAFING DISHES*

LE CHAFING DISH, PAR SON **DESIGN CONTEMPORAIN** ALLIANT ACIER, PORCELAIN ET VERRE OFFRE À VOTRE BUFFET UNE **PRÉSENTATION SOIGNÉE ET RAFFINÉE**.

THE CHAFING DISH, WITH ITS **CONTEMPORARY DESIGN** THAT COMBINES STEEL, PORCELAIN AND GLASS, BRINGS A **SMART AND SOPHISTICATED TOUCH** TO YOUR BUFFET DISPLAY.

EL CHAFING DISH, POR SU **DISEÑO CONTEMPORÁNEO** QUE COMBINA ACERO, PORCELANA Y CRISTAL OFRECE A SU BUFFET UNA PRESENTACIÓN **CUIDADA Y REFINADA**.



Couvercle en verre transparent pour percevoir le contenu et rendre le buffet plus gourmand

Clear glass cover allows contents to be viewed instantly and makes the buffet more enticing

Cubierta de vidrio transparente permite que el contenido pueda ser visto instantáneamente y hace que el buffet más atractivo

Charnière avec vérin et amortisseur pour un réel confort d'utilisation et une fermeture en douceur

The hydraulic buffering hinge offers user comfort and convenience with its soft closure mechanism

La bisagra con amortiguación hidráulica ofrece al usuario comodidad y conveniencia con su mecanismo de cierre suave



Encoches pour les couverts de service

The notch for the serving cutlery

El agua condensada se recoge mediante un sistema de la ranura para las piezas de servicio

Compatible plaque induction, avec résistance électrique ou porte-brûleur avec gel combustible

Compatible with induction, electrical and/or «sterno» fuel heating system

Compatible con inducción, eléctrico o sistema de color externo

Système de récupération d'eau de condensation

Condensation water collection system in the porcelain insert

El agua condensada se recoge mediante un sistema de recolección en la base de porcelana

*CERTAINES PIÈCES SONT DISPONIBLES EN PIÈCES DÉTACHÉES
SOME ITEMS ARE AVAILABLE INDIVIDUALLY
ALGUNOS DE ESTOS ARTICULOS ESTÁN DISPONIBLES COMO PIEZAS SEPARADAS

©Patrick ROUGEREAU



Chafing dishes

EVENTO





236195
CHAFING DISH SANS BAC FINITION MIROIR
 CHAFING DISH WITHOUT INSERT MIRROR FINISH
 CHAFING DISH SIN BANDEJA ACABADO BRILLO
 Ø 35,5 CM - P 41 CM - H 15 CM
 Ø 14 IN - D 16 IN^{1/8} - H 5 IN^{7/8}

Acier inoxydable, couvercle avec gouttière, verre trempé
 Stainless steel, lid with groove, tempered glass
 Acero inoxidable, tapa con canalón vidrio templado



236194
CHAFING DISH SANS BAC FINITION BROSSÉE
 CHAFING DISH WITHOUT INSERT BRUSHED FINISH
 CHAFING DISH SIN BANDEJA ACABADO SATINADO
 Ø 35,5 CM - P 41 CM - H 15 CM
 Ø 14 IN - D 16 IN^{1/8} - H 5 IN^{7/8}

Acier inoxydable, couvercle avec gouttière, verre trempé
 Stainless steel, lid with groove, tempered glass
 Acero inoxidable, tapa con canalón vidrio templado



203470
COUVERCLE AVEC GOUTTIÈRE ACIER, VERRE TREMPÉ
 LID WITH STAINLESS STEEL GUTTER, TEMPERED GLASS
 TAPA EN ACERO INOX Y VIDRIO TEMPLADO
 Ø 33 CM - 13 IN



216142
BAC ACIER POUR CHAFING DISH
 CHAFING STAINLESS STEEL INSERT
 BANDEJA DE ACERO INOXIDABLE PARA CHAFING
 Ø 35,6 X H 7 CM - CONTENANCE 3L
 Ø 14 X 2 IN^{3/4} - CAPACITY 100 OZ



215721
BAC PORCELAINE POUR CHAFING DISH
 CHAFING PORCELAIN INSERT
 BANDEJA DE PORCELANA PARA CHAFING
 Ø 35,6 X H 7 CM - CONTENANCE 3L
 Ø 14 X 2 IN^{3/4} - CAPACITY 100 OZ



202635
1/2 BAC PORCELAINE POUR CHAFING DISH
 1/2 CHAFING PORCELAIN INSERT
 1/2 BANDEJA DE PORCELANA PARA CHAFING
 L 29 X L15 X H 4,5 CM - CONTENANCE 1L
 11 IN^{7/16} X 5 IN^{7/8} X 1 IN^{3/4} - CAPACITY 33 OZ^{13/16}

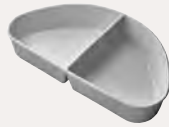

236684 **NEW**
1/2 BAC PORCELAINE POUR CHAFING DISH AVEC SEPARATEUR
 1/2 PORCELAIN INSERT FOR CHAFING DISH
 1/2 BANDEJA DE PORCELANA CON DELIMITADOR PARA CHAFING
 L 29,3 CM X H 4,6 CM
 L 11 IN^{9/16} X H 1 IN^{13/16}

SUPPORT CHAFING
ACIER INOXYDABLE POUR RÉSISTANCE ÉLECTRIQUE OU PORTE-BRÛLEUR AVEC GEL COMBUSTIBLE
 CHAFING STAND STAINLESS STEEL, FOR ELECTRICAL AND/OR STERNO HEATING PURPOSES
 SOPORTE PARA CHAFING DISH ACERO INOXIDABLE PARA RESISTENCIA ELÉCTRICA O CALENTADOR EXTERNO

Ø 35 CM - P 40 CM - H 12,5 CM
 Ø 13 IN^{3/4} X D 15 IN^{3/4} X H 4 IN^{15/16}



203005
FINITION MIROIR
 MIRROR FINISH
 ACABADO BRILLO



202859
FINITION BROSSÉE
 BRUSHED FINISH
 ACABADO SATINADO



RÉSISTANCE AVEC RÉGULATEUR DE TEMPÉRATURE
 HEATING ELEMENT - HEAT ADJUSTABLE
 RESISTENCIA CON REGULADOR DE TEMPERA
 202860 - 220 /240 V /200 W
 203468 - 110 /120 V
 20 X 20 CM - 7 IN^{7/8} X 7 IN^{7/8}



202861
PORTE-BRÛLEUR POUR GEL COMBUSTIBLE ACIER
 BURNER HOLDER STEEL
 QUEMADOR ACERO INOXIDABLE
 Ø 9 CM - H 6 CM
 Ø 3 IN^{9/16} X 2 IN^{3/8}

Chafing dishes

EVENTO



MODULES FROIDS*

REFRIGERATED UNITS - MODULOS REFRIGERADOS

LE MODULE RÉFRIGÉRÉ REÇOIT UNE **LARGE GAMME DE CONTENANTS**, PLATEAUX ET ACCESSOIRES **MULTI-MATÉRIAUX** AU FORMAT GN EN PORCELAINE, VERRE, ACIER, ACRYLIQUE, MÉLAMINE PIERRE ET MÉLAMINE BOIS. **ILS PERMETTENT UNE INFINITÉ DE COMBINAISONS.**

THE REFRIGERATED UNIT WILL HOLD A **WIDE RANGE OF PLATTERS** AND **MULTI-MATERIAL** ACCESSORIES IN INDUSTRY STANDARD FORMAT IN PORCELAIN, GLASS, STEEL, ACRYLIC STONE AND WOOD MELAMINE **ALLOWING ENDLESS COMBINATIONS.**

EL MÓDULO REFRIGERADO PRESENTA **UNA AMPLIA VARIEDAD DE BANDEJAS Y ACCESORIOS DE MÚLTIPLES MATERIALES** EN FORMATO GN EN PORCELANA, VIDRIO, ACERO, ACRÍLICO, MELAMINA DE PIEDRA Y MELAMINA MADERA QUE **PERMITEN UN NÚMERO INFINITO DE COMBINACIONES.**



**MODULE ACIER GN 1/1⁽¹⁾
+ BAC PLASTIQUE**
REFRIGERATED SET
+ PLASTIC TRAY GN 1/1
MODULO DE ACERO
+ BANDEJA GN 1/1
L 56,5 CM - P 36 CM - H 9,5 CM
22 IN^{1/4} - D 14 IN^{3/16} X 3 IN^{3/4}

**202864
FINITION MIROIR**
STAINLESS STEEL MIRROR
ACABADO BRILLO

**202865
FINITION BROSSÉE**
STAINLESS STEEL BRUSHED
ACABADO SATINADO

**202869
NOIR MÉTALLISÉ**
METALLIC BLACK
ACABADO NEGRO METALICO

**MODULE ACIER GN 1/2⁽¹⁾
+ BAC PLASTIQUE**
REFRIGERATED SET
+ PLASTIC TRAY GN 1/2
MODULO DE ACERO
+ BANDEJA GN 1/2
29,5 X 35,6 CM
11 IN^{5/8} X 14 IN

**235356
FINITION MIROIR**
STAINLESS STEEL MIRROR
ACABADO BRILLO

**235361
FINITION BROSSÉE**
STAINLESS STEEL BRUSHED
ACABADO SATINADO

**235362
NOIR MÉTALLISÉ**
METALLIC BLACK
ACABADO NEGRO METALICO

56,5 CM - 22 IN^{1/4}

36 CM - 14 IN^{13/16}



L 56,5 CM X P 36 CM X H 9,5 CM
22 IN^{1/4} X D 14 IN^{3/16} X 3 IN^{3/4}



**202871
COUVERCLE MODULE
RÉFRIGÉRÉ POIGNÉE INOXYDABLE**
LID FOR REFRIGERATED SET/
STAINLESS STEEL HANDLE
CUBIERTA PARA EL MODULO
REFRIGERADO/ASA ACERO INOXIDABLE
56 X 35 X 19 CM
22 IN^{1/16} X 13 IN^{3/4} X 7 IN^{1/2}

**208357
PLAQUE EUTECTIQUE POUR
MODULE FROID GN1/1**
BLACK COOLING
EUTECTIQUE BLOCK FOR UNIT GN1/1
NEGRO ACUMULADOR DE
REFRIGERACION 1/1
48 X 28 X 3 CM
18 IN^{2/8} X 11 IN X 1 IN^{3/16}

**234568
PLAQUE EUTECTIQUE POUR
MODULE FROID GN 1/2**
BLACK COOLING
EUTECTIQUE BLOCK FOR UNIT GN1/2
NEGRO ACUMULADOR DE
REFRIGERACION 1/2
18 X 25 CM
7 IN^{18/16} X 9 IN^{13/16}

⁽¹⁾ GARANTIE LAVE-VAISSELLE
DISH WASHER SAFE
GARANTIA LAVA-VAJILLAS

*CERTAINES PIÈCES SONT DISPONIBLES EN PIÈCES DÉTACHÉES
SOME ITEMS ARE AVAILABLE INDIVIDUALLY
ALGUNOS DE ESTOS ARTICULOS ESTÁN DISPONIBLES COMO
PIEZAS SEPARADAS

EVENTO



PLATEAUX POUR MODULES FROIDS

PLATTERS FOR REFRIGERATED UNITS
BANDEJAS PARA LOS MODULOS REFRIGERADOS

	GN 1/1 53,5 X 32,5 CM 20 IN ^{7/8} X 12 IN ^{13/16}	GN 2/3 35,4 X 32,5 CM 13 IN ^{15/16} X 12 IN ^{13/16}	GN 1/2 26,4 X 32,5 CM 10 IN ^{3/8} X 12 IN ^{13/16}	GN 1/3 17,5 X 32,5 CM 6 IN ^{7/8} X 12 IN ^{13/16}	GN 1/6 8,7 X 32,5 CM 3 IN ^{7/16} X 12 IN ^{13/16}
PLATEAU GRÈS CARBONE⁽¹⁾ GRES STONEWARE TRAY BANDEJA GRES TONO CARBONO					
234550 - GN 2/3 234555 - GN 1/3					
PLAT À REBORDS GRÈS CARBONE⁽¹⁾ GREY STONEWARE EDGE TRAY BANDEJA CON BORDES GRES TONO CARBONO					
234556 - GN 1/3					
PLATEAU PORCELAINE WHITE ENAMELLED PORCELAIN TRAY BANDEJA PORCELANA					
202628 - GN 2/3 202629 - GN 1/2 202627 - GN 1/3					
PLAT CREUX PORCELAINE WHITE ENAMELLED PORCELAIN DEEP DISH BANDEJA PORCELANA					
202630 - GN 1/3					

PLATEAU MÉLAMINE BOIS⁽²⁾

WOOD MELAMINE TRAY
BANDEJA MELAMINA MADERA

234546 - GN 1/1
234548 - GN 2/3
234551 - GN 1/2
234553 - GN 1/3

PLATEAU 3 TROUS MÉLAMINE BOIS⁽²⁾
WOOD MELAMINE TRAY 3 HOLES
BANDEJA MELAMINA MADERA CON 3 HUELLAS

234557 - GN 1/6

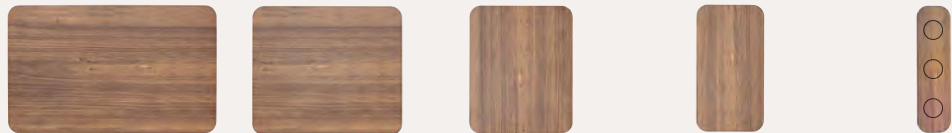

PLATEAU MÉLAMINE PIERRE⁽²⁾

STONE MELAMINE TRAY
BANDEJA MELAMINA PIEDRA

234547 - GN 1/1
234549 - GN 2/3
234552 - GN 1/2
234554 - GN 1/3

PLATEAU 3 TROUS MÉLAMINE PIERRE⁽²⁾
STONE MELAMINE TRAY 3 HOLES
BANDEJA MELAMINA PIEDRA CON 3 HUELLAS

234558 - GN 1/6

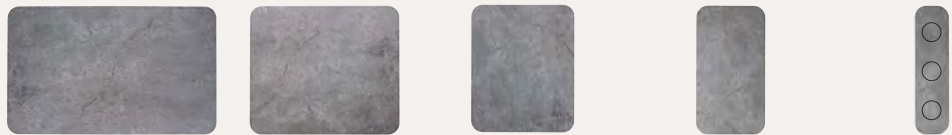

PLATEAU ACIER 18-10 NEWPORT FINITION MIROIR

SERVING TRAY STAINLESS STEEL 18-10
MIRROR FINISHED
BANDEJA RECTANGULAR ACERO 18-10
ACABADO BRILLO

185021 - 238962* - GN 1/1
185019 - 238960* - GN 1/2



PLATEAU VERRE ÉPAISSEUR 0,6 CM

TEMPERED GLASS TRAY THICKNESS 1/4
BANDEJA CRISTAL GROSOR 0,6 CM

230752 - GN 1/1
230753 - GN 2/3



PLATEAU ACRYLIQUE ÉPAISSEUR 1 CM

ACRYLIC TRAY THICKNESS 3/8
BANDEJA ACRÍLICO GROSOR 1 CM

2 TROUS - 2 HOLES - 2 AGUJEROS

230756 - GN 1/1

1 TROU - 1 HOLE - 1 AGUJERO

230755 - GN 1/2

Adapté aux bols 22 cm - Adapted for bowls
8,6 inch - Adaptados a boles de 22 cm



2 TROUS - 2 HOLES - 2 AGUJEROS

230757 - GN 1/3

Adapté aux bols 14 cm - Adapted for bowls
5,5 inch - Adaptados a boles de 14 cm

*NOUVEAUX CODES À PARTIR DU 01/04/2020
NEW CODES VALID FROM 2020/04/01
NUEVOS CODIGOS A PARTIR DE 01/04/2020

(1) GARANTIE LAVE-VAISSELLE
DISH WASHER SAFE
GARANTIA LAVA-VAJILLAS

GARANTIE MICRO-ONDES
MICROWAVE SAFE
GARANTIA MICRO-ONDAS

(2) COMPATIBLE LAVE-VAISSELLE
DISH WASHER SAFE
GARANTIA LAVA-VAJILLAS

NON COMPATIBLE MICRO-ONDES
DON'T USE WITH MICRO-WAVE
NO VA EN EL MICRO-ONDAS

EVENTO



URNES À JUS DE FRUITS*

FRUIT JUICE URNS - DISPENSADORES DE ZUMOS

URNE À JUS DE FRUIT DOTÉE D'UN TUBE CENTRAL EN ACIER POUR GLACE PILÉE :
PARFAIT MAINTIEN DE LA FRAÎCHEUR

FRUIT JUICE URN WITH CENTRAL STEEL TUBE TO HOLD CRUSHED ICE,
FOR PERFECT FRESHNESS

DISPENSADOR DE ZUMOS DOTADO CON UN TUBO CENTRAL DE ACERO PARA
HIELO PICADO **PARA MANTENER LA FRESCURA**

URNE À JUS DE FRUITS 4L - ACIER 18-10

JUICE DISPENSER 135 OZ STAINLESS STEEL
DISPENSADOR DE ZUMO ACERO

231303	231304
MIROIR	BROSSÉ
MIRROR	BRUSHED
ACABADO BRILLO	ACABADO SATINADO

202855 BOUCHON DE CARAFE SILICONE

STOPPER FOR CARAFE - SILICONE
TAPÓN PARA BOTELLA - SILICONA
Ø 6,5 CM - H 4,2 CM
Ø 2 IN^{9/16} X H 1 IN^{5/8}



202639 CARAFE À JUS DE FRUIT - 1,2 L CRISTALLIN SOUFFLÉ BOUCHE

JUICE/BEVERAGE CARAFE - 40 OZ^{9/16}
HAND BLOWN CRYSTALLINE
BOTELLA PARA ZUMOS
CRISTAL SOPLADO EN BOCA
Ø 10,5 CM - H 27,5 CM
Ø 4 IN^{1/8} X H 10 IN^{3/16}

NEW 237501 RAFRAICHISSEUR DROIT DOUBLE PAROI

CURVED DOUBLE WALL WINE COOLER
ENFRIADOR DE BOTELLA DOBLE PARED
Ø 13,9 X H 19,8 CM
Ø 5 IN^{7/8} X H 7 IN^{13/16}



202632
**ÉTIQUETTE PORCELAIN
AVEC AIMANT+ SUPPORT ACIER**
PORCELAIN STICK + STAINLESS STEEL STAND
WITH MAGNET
ÉTIQUETA PORCELANA + SOPORTE ACERO
INOX CON IMÁN
10 X 5 CM - 3 IN^{15/16} X 1 IN^{15/16}



*CERTAINES PIÈCES SONT DISPONIBLES EN PIÈCES DÉTACHÉES
SOME ITEMS ARE AVAILABLE INDIVIDUALLY
ALGUNOS DE ESTOS ARTICULOS ESTÁN DISPONIBLES COMO PIEZAS SEPARADAS

20 CM - 7 IN^{7/8}

45 CM - 17 IN^{11/16}



4L - 135 OZ
L 20 CM X P 32 CM X H 45 CM
W 7 IN^{7/8} X D 12 IN^{5/8} X H 17 IN^{11/16}



BOUCHON VERSEUR EN SILICONE, POUR UNE MEILLEURE HYGIÈNE

HYGIENIC SILICONE POURING STOPPER

TAPÓN DE SILICONA PARA MAYOR HIGIENE
Y CONTROL DEL VERTIDO

POSSIBILITÉ D'AIMANTER L'ÉTIQUETTE PORCELAIN SUR LE COUVERCLE

MAGNETIC PORCELAIN
NAME PLATE ACCESSORY
FOR LID PLACEMENT

PLACA DE PORCELANA
MAGNÉTICA PARA COLOCAR
LOS NOMBRES



EVENTO



DISTRIBUTEURS À CÉRÉALES*

CEREAL DISPENSERS - DISPENSADORES DE CEREALES

DISTRIBUTEUR À CÉRÉALES 1 OU 3 TUBES
 AVEC AILETTES SOUPLES POUR NE PAS CASSER LES CÉRÉALES

CEREAL DISPENSER 1 OR 3 TUBS WITH
 FLEXIBLE SPOUT SO AS NOT TO BREAK THE CEREALS

DISPENSADOR DE CEREALES 1 O 3 TUBOS CON
 PESTAÑAS FLEXIBLES PARA NO ROMPER LOS CEREALES



231300 - X3
 L 50 CM X P 20 CM X H 55,5 CM
 W 19 IN^{11/16} X D 7 IN^{7/8} X H 21 IN^{7/8}
 CAPACITÉ : 3 X 3,5 L
 CAPACITY : 3 X 1 GAL

202855
BOUCHON DE CARAFE SILICONE
 STOPPER FOR CARAFE - SILICONE
 TAPÓN PARA BOTELLA - SILICONA
 Ø 6,5 CM - H 4,2 CM
 Ø 2 IN^{3/16} X H 1 IN^{5/8}



202636
CARAFE À LAIT - 1,2 L
PORCELAINE
 PORCELAIN MILK JUG - 40 OZ^{9/16}
 BOTELLA PARA LECHE
 PORCELANA
 Ø 10,5 CM - H 27,5 CM
 Ø 4 IN^{1/8} X H 10 IN^{13/16}

*CERTAINES PIÈCES SONT DISPONIBLES EN PIÈCES DÉTACHÉES
 SOME ITEMS ARE AVAILABLE INDIVIDUALLY
 ALGUNOS DE ESTOS ARTICULOS ESTÁN DISPONIBLES COMO PIEZAS SEPARADAS

19 CM - 7 IN^{1/2}



231299 - X1
 L 19 CM X P 20 CM X H 55,5 CM
 W 7 IN^{1/2} X D 7 IN^{7/8} X H 21 IN^{7/8}
 CAPACITÉ : 3,5 L
 CAPACITY : 1 GAL

154245
BOL MODULO BLANC
 WHITE MODULO BOWL
 BOL MODULO BLANCO
 14 CM - 5 IN^{1/2}



202626
BOL EMPILABLE
 PORCELAIN STACKABLE BOWL
 BOWL PORCELANA APILABLE
 14 CM - 5 IN^{1/2}



EVENTO



SUPPORTS À FIL RECTANGULAIRES

RECTANGULAR TRAYS - SOPORTES RECTANGULARES

DES SUPPORTS EN **ACIER NOIR MAT DE HAUTEURS DIFFÉRENTES** POUR RYTHMER LES PRÉSENTATIONS

BLACK MAT FINISH SUPPORTS OF DIFFERING HEIGHTS CAN BE USED TO CREATE A VARIED PRESENTATION

SOPORTES DE **ACERO NEGRO DE DIFERENTES ALTURAS PARA MARCAR** EL RITMO DE LAS PRESENTACIONES

230741 SUPPORT RECTANGULAIRE NIVEAU 1

RECTANGULAR TRAY, LEVEL 1
SOPORTE RECTANGULAR, NIVEL 1
L 44 X P 30,8 X H 10,8 CM
W 17 IN^{5/16} X D 12 IN^{1/8} X H 4 IN^{1/4}



230742 SUPPORT RECTANGULAIRE NIVEAU 2

RECTANGULAR TRAY, LEVEL 2
SOPORTE RECTANGULAR, NIVEL 2
L 42 X P 30,8 X H 29,8 CM
W 16 IN^{5/16} X D 12 IN^{1/8} X H 11 IN^{3/4}

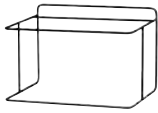

230741 + 230742 SUPPORT RECTANGULAIRE NIVEAU 1+2

RECTANGULAR TRAY, LEVEL 1+2
SOPORTE RECTANGULAR, NIVEL 1+2
L 44 X P 50 X H 29,8 CM
W 17 IN^{5/16} X D 19 IN^{11/16} X H 11 IN^{3/4}

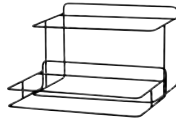

230743 SUPPORT RECTANGULAIRE NIVEAU 3

RECTANGULAR TRAY, LEVEL 3
SOPORTE RECTANGULAR, NIVEL 3
L 40 X P 30,8 X H 48,8 CM
W 15 IN^{3/4} X D 12 IN^{1/8} X H 19 IN^{3/16}

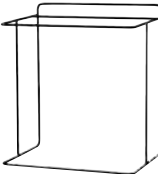

230742 + 230743 SUPPORT RECTANGULAIRE NIVEAU 2+3

RECTANGULAR TRAY, LEVEL 2+3
SOPORTE RECTANGULAR, NIVEL 2+3
L 42 X P 50 X H 48,8 CM
W 16 IN^{5/16} X D 19 IN^{11/16} X H 19 IN^{3/16}

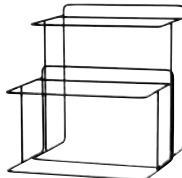

230741 + 230742 + 230743 SUPPORT RECTANGULAIRE NIVEAU 1+2+3

RECTANGULAR TRAY, LEVEL 1+2+3
SOPORTE RECTANGULAR, NIVEL 1+2+3
L 44 X P 68,2 X H 48,8 CM
W 17 IN^{5/16} X D 26 IN^{7/8} X H 19 IN^{3/16}



230749 PANIÈRE RECTANGULAIRE - GN 1/1

RECTANGULAR BREAD BASKET
CESTA BOLLERÍA RECTANGULAR
54 X 34 X H 7 CM
21IN^{1/4} X 13 IN^{3/8} X 2 IN^{3/4}



PANIÈRE REVERSIBLE POUR UNE PRÉSENTATION DROITE OU INCLINÉE

REVERSIBLE BASKET FOR A LEVEL OR TITLED DISPLAY
PANERA REVERSIBLE PARA UNA PRESENTACION DERECHA O INCLINADA



230744 CADRE ACIER POUR SUPPORT RECTANGULAIRE⁽¹⁾

STEEL FRAME FOR STAND
ESTRUCTURA DE ACERO
L 55,5 X P 35 X H 4,5 CM
W 21IN^{7/8} X D 13 IN^{3/4} X H 1IN^{3/4}



185021 - GN1/1
PLATEAU ACIER 18-10
NEWPORT FINITION MIROIR
SERVING TRAY STAINLESS STEEL 18-10
MIRROR FINISHED
BANDEJA RECTANGULAR ACERO 18-10
ACABADO BRILLO



230752 - GN1/1
PLATEAU VERRE
ÉPAISSEUR 0,6 CM
TEMPERED GLASS TRAY THICKNESS 1/16"
BANDEJA CRISTAL GROSOR 0,6 CM



234546 - GN1/1
PLATEAU MÉLAMINE BOIS⁽¹⁾
WOOD MELAMINE TRAY
BANDEJA MELAMINA MADERA



234547 - GN1/1
PLATEAU MÉLAMINE PIERRE⁽¹⁾
STONE MELAMINE TRAY
BANDEJA MELAMINA PIEDRA



(1) À COMMANDER UNIQUEMENT POUR LES PLATEAUX GN 1/1
TO ORDER ONLY FOR TRAYS GN 1/1
SOLO PEDIR PARA LOS BANDEJAS GN1/1

(2) COMPATIBLE LAVE-VAISSELLE DONT USE WITH MICRO-ONDES
DISH WASHER SAFE NO VA EN EL MICRO-ONDAS
GARANTIA LAVA-VAJILLAS

EVENTO



SUPPORTS À FIL RONDS

ROUND TRAYS - RONDOS BANDEJAS

POUR PANIÈRES RONDES, PLATEAUX 32 CM ET SALADIERS

STANDS FOR ROUND BASKETS, TRAYS 12 IN^{5/8} AND SALAD BOWLS

SOPORTES PARA RONDO, BANDEJAS 32 CM, BOL Y ENSALADERAS

230745
SUPPORT ROND BAS
ROUND STAND, LOW LEVEL
SOPORTE REDONDO BAJO
Ø 25 CM X H 13 CM
Ø 9 IN^{13/16} X H 5 IN^{1/8}

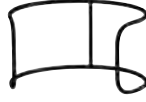

230746
SUPPORT ROND HAUT
ROUND STAND, HIGH LEVEL
SOPORTE REDONDO ALTO
Ø 25 CM X H 26 CM
Ø 9 IN^{13/16} X H 10 IN^{1/4}



234564
SALADIER BAS GRÈS CARBONE⁽¹⁾
GREY STONEWARE LOW SALAD BOWL
ENSALADERA GRES TAMANO BAJO
TONO CARBONO
Ø 25,4 X 7 CM - 2,4 L
Ø 10 IN X 2 IN^{3/4} - 80 OZ^{1/8}



136524
**PLATEAU ROND
PORCELAINE MODULO**
PIE/PIZZA PLATE, FLAT
FUENTE PARA PASTEL
Ø 32 CM - 12 IN^{5/8}



234563
SALADIER HAUT GRÈS CARBONE⁽¹⁾
GREY STONEWARE HIGH SALAD BOWL
ENSALADERA GRES TAMANO ALTO
TONO CARBONO
Ø 25,4 X 13 CM - 5,1 L
Ø 10 IN X 5 IN^{1/8} - 172 OZ^{7/16}



234561
**PLATEAU ROND
MÉLAMINE BOIS⁽²⁾**
WOOD MELAMINE
ROUND TRAY
BANDEJA REDONDA
MELAMINA MADERA
Ø 32 CM - 12 IN^{5/8}

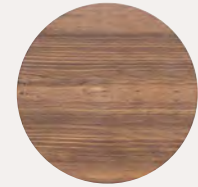

230748
PANIÈRE RONDE
ROUND BREAD BASKET
CESTA BOLLERÍA REDONDA
Ø 32 CM X H 8 CM
Ø 12 IN^{5/8} X H 3 IN^{1/8}



234562
**PLATEAU ROND
MÉLAMINE PIERRE⁽²⁾**
STONE MELAMINE
ROUND TRAY
BANDEJA REDONDA
MELAMINA PIEDRA
Ø 32 CM - 12 IN^{5/8}



230750
PANIÈRE INDIVIDUELLE
INDIVIDUAL BREAD BASKET
CESTA BOLLERÍA INDIVIDUAL
Ø 18 CM X H 6 CM
Ø 7 IN^{1/16} X H 2 IN^{3/8}



230754
**PLATEAU ROND
VERRE GRIS**
GREY ROUND TRAY
TEMPERED GLASS
BANDEJA CRISTAL
REDONDA
Ø 32 CM - 12 IN^{5/8}



NEW
235223
SALADIER BAHIA DUNE
BEIGE DUNE BOWL
ENSALADERA BEIS DUNA
25 CM - 4L
11 IN - 135 OZ^{1/4}



NEW
235222
SALADIER BAHIA BLEU ROCHE
BLUE STONE BOWL
ENSALADERA AZUL DE ROCA
25 CM - 4L
11 IN - 135 OZ^{1/4}



(1) COMPATIBLE LAVE-VAISSELLE
DISH WASHER SAFE
GARANTIA LAVA-VAJILLAS
COMPATIBLE MICRO-ONDES
MICROWAVE SAFE
GARANTIA MICRO-ONDAS

(2) COMPATIBLE LAVE-VAISSELLE
DISH WASHER SAFE
GARANTIA LAVA-VAJILLAS
NON COMPATIBLE MICRO-ONDES
DO NOT USE WITH MICRO-WAVE
NO VA EN EL MICRO-ONDAS

EVENTO



ACCESSOIRES

ACCESSORIES - ACCESORIOS

230751
PANIÈRE À BAGUETTE
BAGUETTE BASKET
CESTA PARA BAGUETTE
27 CM X H 52 CM
10 IN^{5/8} X H 20 IN^{1/2}



234559
PLANCHA AVEC MANCHE MÉLAMINE BOIS⁽¹⁾
WOOD MELAMINE BOARD
PLANCHA CON MANGO
MELAMINA MADERA
17,5 X 45 CM - 6 IN^{7/8} X 17 IN^{11/16}



234560
PLANCHA AVEC MANCHE MÉLAMINE PIERRE⁽¹⁾
STONE MELAMINE BOARD
PLANCHA CON MANGO
MELAMINA PIEDRA
17,5 X 45 CM - 6 IN^{7/8} X 17 IN^{11/16}



202632
ETIQUETTE PORCELAINE AVEC AIMANT + SUPPORT ACIER
PORCELAIN STICK + STAINLESS STEEL
STAND + MAGNET
ETIQUETA PORCELANA + SOPORTE ACERO
INOX CON IMAN
10 X 5 CM - 3 IN^{15/16} X 1 IN^{15/16}



202633
SUPPORT COUVERTS DE SERVICE PORCELAINE
SERVING CUTLERY DISPLAY
WHITE PORCELAIN
SOPORTE PARA PIEZAS DE SERVICIO
PORCELANA BLANCA
21 X 10 X 5 CM
8 IN^{1/4} X 3 IN^{15/16} X 1 IN^{15/16}



168845 
CUILLÈRE À SPAGHETTI
SPAGHETTI SERVING SPOON
CUCHARA PARA ESPAGUETIS
29 CM - 11 IN^{7/16}



168844 
FOURCHÈTE À VIANDE
MEAT FORK
TENEDOR DE CARNE
29 CM - 11 IN^{7/16}



130610 
REPOSE CUILLÈRE PORCELAINE
SPOON REST WITH CERAMIC BOWL
CUCHARA DESCANSA EN PORCELANA
H 23,5 CM X L 11,5 CM - 9 IN^{3/4} X 4 IN^{1/2}



153193 
LOUCHE ASTRÉE MIROIR
SOUP LADLE
CAZO
29,7 CM - 11 IN^{11/16}



202854
PLANCHE À PAIN BAMBOU AVEC RÉCUPÉRATEUR DE MIETTES (GN 1/1)
BAMBOO BREAD BOARD WITH CRUMB TRAY (GN 1/1)
PANERA BAMBOO CON RECOGEDOR DE MIGAS (GN 1/1)
53 X 32,5 CM - 20 IN^{7/8} X 12 IN^{13/16}



229516
COUPEAU L'ECONOME BY STARCK® POSITIONNABLE DANS LA PLANCHE
L'ECONOME BY STARCK® BREAD KNIFE FITS IN A SLOT IN THE BREAD BOARD
CUCHILLO DE PAN L'ECONOME BY STARCK® SE ENCAJA EN UNA RANURA DE LA PANERA
24 CM - 9 IN^{7/16}



217814
COUPEAU L'ECONOME ECO NATURE® POSITIONNABLE DANS LA PLANCHE
L'ECONOME ECO NATURE® BREAD KNIFE FITS IN A SLOT IN THE BREAD BOARD
CUCHILLO DE PAN L'ECONOME ECO NATURE® SE ENCAJA EN UNA RANURA DE LA PANERA
18 CM - 7 IN^{1/16}



217814
PRÉSENTOIR À GÂTEAUX ROND
ROUND APP / PIZZA / PRESENTATION STAND
EXPOSITOR DE TARTAS



209381
Ø 25 CM - 9 IN^{13/16}

209382
Ø 32 CM - 12 IN^{5/16}

202625
BOL EVENTO BLANC
WHITE EVENTO BOWL
BOL EVENTO BLANCO
22 CM - 8 IN^{11/16}



142722
BOL PORCELAINE MODULO
DEEP BOWL, LARGE
BOL HONDO
28 CM - 11 IN
CONTENANCE : 2,5 L
CAPACITY : 84 OZ^{3/16}
H : 12 CM - 4 IN^{3/4}



204499  184355 
PINCE À SERVIR
SERVING TONG
PINZAS PARA SERVIR
29,5 CM - 11 IN^{5/8}



204498  101492 
PINCE À PAIN
BREAD TONG
PINZAS PAN
23 CM - 9 IN^{1/16}



204496  101494 
CISEAUX À GÂTEAUX
PASTRY SCISSORS/TONG
PINZAS PARA PASTELES
20 CM - 7 IN^{7/8}



130994 
CUILLÈRE À TOAST
APPETIZER SPOON
CUCHARA APERITIVO
11,8 CM - 4 IN^{5/8}



(1) COMPATIBLE LAVE-VAISSELLE
DISH WASHER SAFE
GARANTIA LAVA-VAJILLAS

NON COMPATIBLE MICRO-ONDES
DONT USE WITH MICRO-WAVE
NO VA EN EL MICRO-ONDAS

(1) PLANCHE DE PRESENTATION UNIQUEMENT, NE PAS FAIRE DE DÉCOUPE
PRESENTATION BOARD, DON'T CUT ON IT
PLANCHA DE PRESENTACIÓN, NO ES COMPATIBLE CON EL CORTE

EVENTO





29,5 CM - 11 IN^{5/8}

56,5 CM - 22 IN^{1/4}

56,5 CM - 22 IN^{1/4}

56,5 CM - 22 IN^{1/4}



153193

235361

230757

230755

202865

202869

202864

202627

230753

234552

202629

230757

234548

202627

230753

234552

202629

202633

202633

202633

41 CM - 16 IN^{7/8}



215722



216144

35,5 CM - 14 IN

35,5 CM - 14 IN

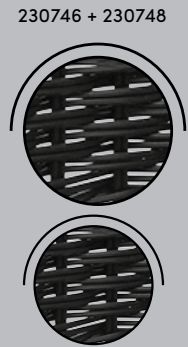

230746 + 230748

230745 + 230750

68,2 CM - 26 IN^{7/8}



230744 +

36 CM - 14 IN^{3/16}

EVENTO



44 CM - 14 IN



Ø 27 CM X H 52 CM
Ø 10 IN^{5/8} X H 20 IN^{1/2}



Ø 25,4 CM X H 13 CM
Ø 10 IN X H 5 IN^{1/8}



234562
Ø 32 CM - 12 IN^{5/8}



20 CM - 7 IN^{7/8}

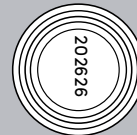
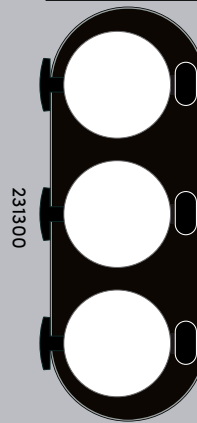

32 CM - 12 IN^{5/8}

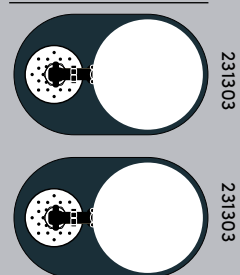

35,5 CM - 14 IN

50 CM - 19 IN^{1/16}

20 CM
7 IN^{7/8}

20 CM
7 IN^{7/8}



PIÈCES DÉTACHÉES

SPARE PARTS - PIEZAS SEPARADAS

CHAFING DISH

203470
**COUVERCLE AVEC GOUTTIÈRE
ACIER ET VERRE TREMPÉ**
LID WITH STAINLESS STEEL GUTTER,
TEMPERED GLASS
TAPA EN ACERO INOX
Y VIDRIO TEMPLADO
Ø 33 CM - Ø 13 IN

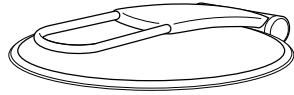

217435
KIT SAV VÉRINS POUR CHAFING DISH
REPLACING KIT FOR CHAFING DISH CYLINDER
KIT PARA CAMBIAR EL CILINDRO DE UN CHAFING DISH

227406
JOINT POUR CHAFING DISH
SEAL FOR CHAFING DISH
JUNTA PARA CHAFING DISH

MODULE FROID

REFRIGERATED UNIT - MODULO REFRIGERADOS

202866
BAC PLASTIQUE
PLASTIC TRAY
BANDEJA
56 X 35,5 X 8 CM
22 IN^{1/8} X 14 IN X 3 IN^{1/8}



235357
BAC PLASTIQUE
PLASTIC TRAY
BANDEJA
29,5 X 35,6 CM
11 IN^{5/8} X 14 IN



EVENTO

URNE À JUS DE FRUITS

FRUIT JUICE URN - DISPENSADOR DE ZUMOS

COUVERCLE URNE ACIER 18-10LID FOR STAINLESS DISPENSER 18-10
TAPA PARA ACERO DISPENSADOR 18-10
Ø 17,9 CM - 7 IN^{1/16}

202881	202891
MIROIR	BROSSÉ
MIRROR	BRUSHED
ACABADO BRILLO	ACABADO SATINADO

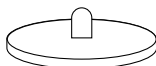

202884
TUBE ACIER POUR GLACE
ICE TUBE STAINLESS STEEL
TUBO PARA HIELO ACERO 18-10
Ø 9 CM - 3 IN^{9/16}

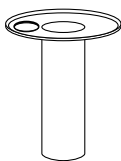

202883
FÛT CYLINDRIQUE URNE
CONTAINER FOR DISPENSER
CONTENEDOR PARA EL DISPENSADOR SAN
5L - 169 OZ^{1/16}
Ø 17,7 CM X H 25,5 CM
Ø 6 IN^{5/16} X H 10 IN^{1/16}

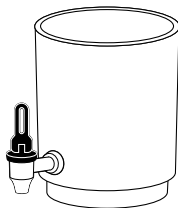

214724
ROBINET ACIER
STAINLESS STEEL FAUCET
GRIFO ACERO
+ ABS NOIR, BLACK, NEGRO

BASE ACIER 18-10 URNE
STAINLESS STEEL STAND FOR DISPENSER 18-10
SOPORTE ACERO PARA DISPENSADOR 18-10
Ø 17,6 CM - H 19 CM
Ø 6 IN^{5/16} X H 7 IN^{1/2}

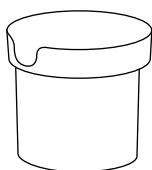

202890	202889
MIROIR	BROSSÉ
MIRROR	BRUSHED
ACABADO BRILLO	ACABADO SATINADO

045963
GRILLE ACIER POUR GOUTTES - 18/10
STAINLESS STEEL GRID DROP COLLECTOR
REJILLA DE ACERO PARA RECOGER EL GOTELO
Ø 9 CM - 3 IN^{9/16}



230758
SOCLE NOIR ACRYLIQUE URNE
STAND FOR BLACK DISPENSER
BASE DEL DISPENSADOR NEGRO
20 X 32 CM
7 IN^{7/8} X 12 IN^{5/8}
ÉPAISSEUR/ESPESOR : 2 CM
THICKNESS: 13/16 IN



DISTRIBUTEUR À CÉRÉALES

CEREALES DISPENSER - DISPENSADOR DE CEREALES

213078
**COUVERCLE DISTRIBUTEUR CEREALES
ACIER FINITION MIROIR - 18/10**
LID FOR CEREAL DISPENSER, STAINLESS STEEL,
MIRROR FINISH
TAPA PARA DISPENSADOR EN BRILLO, ACERO
Ø 12,5 CM - Ø 4 IN^{5/16}



213076
**FÛT CYLINDRIQUE AVEC AILETTE
ET POIGNEE DISTRIBUTEUR CEREALES**
BARREL + HANDLE + ROLLING TAP
FOR CEREAL DISPENSER
CONTENEDOR PARA EL DISPENSADOR
CON ALETA Y ASA
P 16,1 X H 42 CM - D 6 IN^{5/16} X H 16 IN^{9/16}

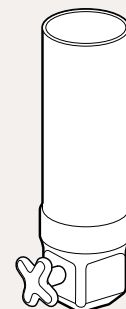

231301
**BASE + TUBE + SOCLE X1
DISTRIBUTEUR À CEREALES**
STAINLESS STEEL STAND + TUB
+ ACRYLIC STAND FOR CEREAL DISPENSER
BASE + TUBO + ZÓCALO DISPENSADOR
DE CEREALES
L 19 X H 27,5 CM - L 7 IN^{1/2} X H 29 IN^{3/4}

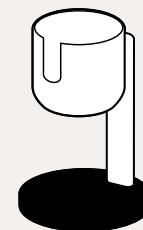

231302
**BASE + TUBE + SOCLE X3
DISTRIBUTEUR À CEREALES**
STAINLESS STEEL STAND + TUB
+ ACRYLIC STAND FOR CEREAL DISPENSER
BASE + TUBO + ZÓCALO
X3 DISPENSADOR DE CEREALES
L 50 X H 27,5 CM - L 19 IN^{10/16} X H 29 IN^{3/4}

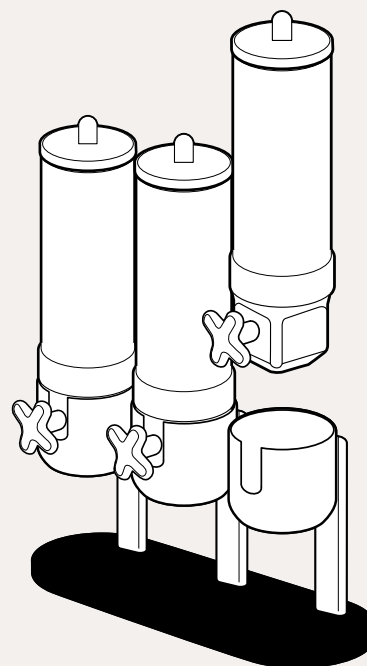





CUISINE

Véritable tradition pour DEGRENNE, le culinaire se décline en **ustensiles de cuisson, de préparation, de découpe et d'affutage**, pour inviter les chefs à la réalisation de recettes savoureuses et délicates. Les gammes coutellerie l'**Unique Sabatier** ainsi que les ustensiles de préparation de la célèbre marque **L'Econome®**, sont **gages de qualité et témoignent d'un véritable esprit précurseur** dans l'histoire de la cuisine française. Experte dans le travail de l'acier et notamment sur l'embouti, DEGRENNE présente également **Newcook Expert, une gamme d'ustensiles de cuisson 100% fabriquée en France**. En alliant **précision, technologie** Multiply et **design**, Newcook Expert promet des moments de création uniques.

KITCHENWARE

Kitchenware is a real tradition at DEGRENNE and our range comprises **cooking, preparation, slicing and sharpening utensils** to encourage chefs to make flavoursome and delicate dishes. The **Unique Sabatier** cutlery ranges and the famous **L'Econome®** brand's food preparation utensils, are a **guarantee of quality** and bear witness to a trailblazing spirit in the history of French cuisine. DEGRENNE has steel-working and specifically metal stamping expertise, and is also presenting **Newcook Expert, a range of cooking utensils entirely made in France**. Newcook Expert promises unique creative moments, as the range combines **precision, Multiply technology** and **great design**.

COCINA

Verdadera tradición para DEGRENNE, lo culinario se declina en **utensilios de cocción, de preparación, de corte y de afilado**, para invitar a los chefs a la preparación de recetas sabrosas y delicadas. Las gamas de cuchillería, **Unique Sabatier**, así como los utensilios de preparación de la famosa marca, **L'Econome®**, son garantía de calidad y dan fe de un verdadero espíritu pionero en la historia de la cocina francesa. Experta en el trabajo del acero, sobre todo en el estampado, DEGRENNE también presenta **Newcook Expert, una gama de utensilios de cocina, 100 % fabricada en Francia**. Aliando **precisión, tecnología** Multiply y **diseño**, Newcook Expert promete momentos de creación únicos.





COUPEAU OFFICE
PARING KNIFE
CUCHILLO MONDADOR
8 CM - 3 IN^{1/16}
218590 **IDÉAL FORGÉ**



COUPEAU OFFICE
PARING KNIFE
CUCHILLO MONDADOR
10 CM - 4 IN
218587 **IDÉAL FORGÉ**
218591 **IDÉAL FORGÉ OLIVIER**



COUPEAU OFFICE BEC OISEAU
CURVED BLADE PARING KNIFE
CUCHILLON MONDADOR PICO DE PAJARO
8 CM - 3 IN^{1/16}
218585 **IDÉAL FORGÉ**



COUPEAU DE CUISINE
CHEF'S KNIFE
CUCHILLO DE COCINA
15 CM - 6 IN
218593 **IDÉAL FORGÉ**
218595 **IDÉAL FORGÉ OLIVIER**



COUPEAU DE CUISINE
CHEF'S KNIFE
CUCHILLO DE COCINA
20 CM - 8 IN
218596 **IDÉAL FORGÉ**
218599 **IDÉAL FORGÉ OLIVIER**



COUPEAU DE CUISINE
CHEF'S KNIFE
CUCHILLO DE COCINA
25 CM - 10 IN
218600 **IDÉAL FORGÉ**
218602 **IDÉAL FORGÉ OLIVIER**



COUPEAU TRANCELARD
SLICING KNIFE
CUCHILLO PARA CORTAR
15 CM - 6 IN
218609 **IDÉAL FORGÉ**
218612 **IDÉAL FORGÉ OLIVIER**



COUPEAU TRANCELARD
SLICING KNIFE
CUCHILLO PARA CORTAR
20 CM - 8 IN
218613 **IDÉAL FORGÉ**

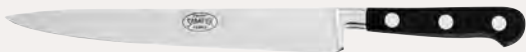

COUPEAU TRANCELARD
SLICING KNIFE
CUCHILLO PARA CORTAR
25 CM - 10 IN
218616 **IDÉAL FORGÉ**



COUPEAU SANTOKU
SANTOKU KNIFE GRANTON EDGE
CUCHILLO SANTOKU
18 CM - 7 IN^{1/16}
218629 **IDÉAL FORGÉ**
218630 **IDÉAL FORGÉ OLIVIER**



COUPEAU FILET DE SOLE
FILETING KNIFE
CUCHILLO PARA FILETAR
15 CM - 6 IN
218611 **IDÉAL FORGÉ**

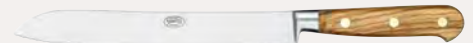
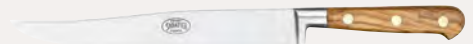

IDÉAL FORGÉ

MADE IN FRANCE

COUPEAU À JAMBON ALVÉOLÉ

HAM SLICER HOLLOW EDGE
CUCHILLO JAMONERO ALVEOLADO
30 CM - 12 IN
218583 **IDÉAL FORGÉ**

COUPEAU À DÉOSSER

BONING KNIFE
CUCHILLO DESHUESADOR
13 CM - 5 IN
218626 **IDÉAL FORGÉ**

COUPEAU À DÉOSSER

BONING KNIFE
CUCHILLO DESHUESADOR
15 CM - 6 IN
218628 **IDÉAL FORGÉ**

FUSIL À AIGUISER-ABS

SHARPENING STEEL-ABS
AFILADOR-ABS
30 CM - 12 IN
217879 **AFFUTAGE COUTELLERIE**

FUSIL À AIGUISER

SHARPENING STEEL
AFILADOR
25 CM - 10 IN
217880 **IDÉAL FORGÉ**

FUSIL À AIGUISER

SHARPENING STEEL
AFILADOR
20 CM - 8 IN
217883 **IDÉAL FORGÉ OLIVIER**

COUPEAU À DÉCOUPER YATAGAN

YATAGAN CARVING KNIFE
CUCHILLO DE TRINCHAR YATAGAN
20 CM - 8 IN
218623 **IDÉAL FORGÉ**
218625 **IDÉAL FORGÉ OLIVIER**

FOURCHETTE À VIANDE

MEAT FORK
TENEDOR DE CARNE
17 CM - 6 IN^{11/16}
217868 **IDÉAL FORGÉ**
217872 **IDÉAL FORGÉ OLIVIER**

COUPEAU À STEAK

STEAK KNIFE
CUCHILLO CHULETERO
13 CM - 5 IN
218579 **IDÉAL FORGÉ**

COUPEAU À PAIN

BREAD KNIFE
CUCHILLO DE PAN
20 CM - 8 IN
218619 **IDÉAL FORGÉ**
218622 **IDÉAL FORGÉ OLIVIER**



L'ECONOME® ECO NATURE
NATURAL HUE - TINTE NATURAL



217523
ÉCONOME
PEALER
PELADOR
10 CM - 4 IN



217687
COUTEAU OFFICE POINTU
PARING KNIFE
CUCHILLO MONDADOR
9 CM - 3 IN ^{15/16}



226270
COUTEAU OFFICE BEC OISEAU
CURVED BLADE PARING KNIFE
CUCHILLON MONDADOR PICO DE PAJARO
6,5 CM - 2 IN ^{5/8}



217804
COUTEAU À DÉCOUPER
CARVING KNIFE
CUCHILLO DE TRINCHAR
20 CM - 8 IN



217806
COUTEAU DE CUISINE
CHEF'S KNIFE
CUCHILLO DE COCINA
15 CM - 6 IN



217808
COUTEAU DE CUISINE
CHEF'S KNIFE
CUCHILLO DE COCINA
20 CM - 8 IN



217814
COUTEAU À PAIN
BREAD KNIFE
CUCHILLO DE PAN
18 CM - 7 IN ^{1/16}

L'ECONOME
BY
STARCK®



229514
**PACK 4 PIECES - ECONOME/
COUTEAU BEC OISEAU/
FLEXICONOME/COUTEAU OFFICE**
PACK 4 PIECES SET - PEELER/
CURVED BLADE PARING KNIFE/
FLEXICONOME/PARING KNIFE/
PAQUETE DE 4 PIEZAS - ECONOME/
BECK CUCHILLOS /FLEXICONOME/
CUCHILLO MONDADOR



229515
COUTEAU DE CUISINE
CHEF'S KNIFE
CUCHILLO DE COCINO
14 CM - 5 IN ^{1/2}

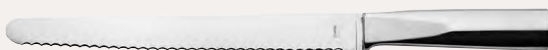

229516
COUTEAU À PAIN
BREAD KNIFE
CUCHILLO DE COCINO
24 CM - 9 IN ^{7/16}

L'ECONOME® BOIS LAQUÉ
GLOSS FINISH WOOD - MADERA LACADA



217528
ÉCONOME® AUBERGINE
PEELER PURPLE
PELADOR BERENJENA
10 CM - 4 IN



217529
ÉCONOME® MANDARINE
PEELER ORANGE
PELADOR MANDARINA
10 CM - 4 IN



217532
ÉCONOME® ANIS
PEELER ANISE
PELADOR ANIS
10 CM - 4 IN



217533
ÉCONOME® FUCHSIA
PEELER FUCHSIA
PELADOR FUCHSIA
10 CM - 4 IN



217691
**COUTEAU OFFICE POINTU
AUBERGINE**
PARING KNIFE PURPLE
CUCHILLO MONDADOR BERENJENA
9 CM - 3 IN ^{15/16}



217692
**COUTEAU OFFICE POINTU
MANDARINE**
PARING KNIFE ORANGE
CUCHILLO MONDADOR MANDARINA
9 CM - 3 IN ^{15/16}



217695
**COUTEAU OFFICE POINTU
ANIS**
PARING KNIFE ANISE
CUCHILLO MONDADOR ANIS
9 CM - 3 IN ^{15/16}



217696
**COUTEAU OFFICE POINTU
FUCHSIA**
PARING KNIFE FUCHSIA
CUCHILLO MONDADOR FUCHSIA
9 CM - 3 IN ^{15/16}



217795
**COUTEAU OFFICE BEC OISEAU
AUBERGINE**
CURVED BLADE PARING KNIFE PURPLE
CUCILLON MONDADOR PICO DE PAJARO BERENJENA
6,5 CM - 2 IN ^{5/8}



217796
**COUTEAU OFFICE BEC OISEAU
MANDARINE**
CURVED BLADE PARING KNIFE ORANGE
CUCILLON MONDADOR PICO DE PAJARO MANDARINA
6,5 CM - 2 IN ^{5/8}



217799
**COUTEAU OFFICE BEC OISEAU
ANIS**
CURVED BLADE PARING KNIFE ANISE
CUCILLON MONDADOR PICO DE PAJARO ANIS
6,5 CM - 2 IN ^{5/8}



217800
**COUTEAU OFFICE BEC OISEAU
FUCHSIA**
CURVED BLADE PARING KNIFE FUCHSIA
CUCILLON MONDADOR PICO DE PAJARO FUCHSIA
6,5 CM - 2 IN ^{5/8}



217540
**FLEXICONOME JULIENNE
AUBERGINE**
JULIENNE FLEXICONOME PURPLE
ABADEJO FLEXICONOME BERENJENA
9 CM - 3 IN ^{15/16}



217538
**FLEXICONOME TOMATE
ANIS**
TOMATO FLEXICONOME ANISE
TOMATO FLEXICONOME ANIS
9 CM - 3 IN ^{15/16}



217536
**FLEXICONOME UNIVERSEL
FUCHSIA**
UTILITY FLEXICONOME FUCHSIA
UNIVERSAL FLEXICONOME FUCHSIA
9 CM - 3 IN ^{15/16}

L'ÉCONOME®

MADE IN FRANCE



CASSEROLES - SAUCEPAN - CAZO



223972
CASSEROLE
SAUCEPAN
CAZO
14 CM - 5 IN^{1/2}

223973
CASSEROLE
SAUCEPAN
CAZO
16 CM - 6 IN^{5/16}

223974
CASSEROLE
SAUCEPAN
CAZO
18 CM - 7 IN^{1/16}

223975
CASSEROLE
SAUCEPAN
CAZO
20 CM - 7 IN^{7/8}

223993
ENSEMBLE DE 3 CASSEROLES
SET OF 3 SAUCEPAN
SET DE 3 CAZOS
16/18/20 CM
6 IN^{5/16} TO 7 IN^{7/8}

COUVERCLES - LIDS - TAPAS



223987
14 CM - 5 IN^{1/2}

223988
16 CM - 6 IN^{5/16}

223989
18 CM - 7 IN^{1/16}

223990
20 CM - 7 IN^{7/8}

223991
24 CM - 9 IN^{7/16}

223992
28 CM - 11 IN

POÊLES - FRYING PAN - SARTÉN



223977
POÊLE
FRYING PAN
SARTÉN
24 CM - 9 IN^{7/16}

223979
POÊLE
FRYING PAN
SARTÉN
28 CM - 11 IN

COCOTTE - FRENCH OVEN - OLLA



223986
COCOTTE OVALE AVEC COUVERCLE
OVAL FRENCH OVEN WITH LID
OLLA OVALADA CON TAPA
24 X 30 CM - 11 IN^{3/16} X 9 IN^{7/16}

FAITOUT - STEWPOT - OLLA



223985
FAITOUT
STEWPOOT
OLLA
24 CM - 9 IN^{7/16}

ACIER INOXYDABLE
STAINLESS STEEL
ACERO INOXIDABLE

ALUMINIUM
ALUMINUM
ALUMINIO

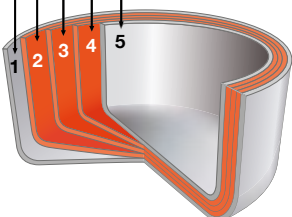

CONDUCTION HOMOGENE ET OPTIMALE DE LA CHALEUR DU FOND JUSQU'EN HAUT DES PAROIS POUR UNE PARFAITE MAÎTRISE DE LA TEMPÉRATURE DE CUISSON

CORPS EXTÉRIEUR EN FINITION INOX ET INTÉRIEUR BROSSÉ

GRADUATION INTÉRIEURE DES LITRAGES

PERFORMANCES PROCHES DES QUALITÉS DE CUISSON OBTENUES AVEC DES USTENSILES EN CUIVRE OU EN FONTE

COMPATIBLE TOUS FEUX DONT INDUCTION

UNIFORM AND OPTIMAL HEAT CONDUCTION FROM THE BASE OF THE PAN TO THE TOP OF THE SIDES FOR A PERFECT CONTROL OF THE COOKING TEMPERATURE

OUTER BODY IN STAINLESS STEEL FINISH AND INSIDE IN BRUSHED STAINLESS STEEL

INTERNAL LITRE SCALE

THE PERFORMANCE IS CLOSE TO COOKING QUALITIES USUALLY OBTAINED FROM COOKING WITH COPPER OR CAST IRON COOKWARE

SUITABLE FOR ALL HOB TYPES INCLUDING INDUCTION

CONDUCCIÓN HOMOGENEA Y ÓPTIMA DEL CALOR DEL FONDO HASTA ARRIBA DE LAS PAREDES PARA UN PERFECTO CONTROL DE LA TEMPERATURA DE COCCIÓN

CUERPO EXTERIOR EN ACABADO DE ACERO INOXIDABLE E INTERIOR EN MATE

GRADUACIÓN INTERIOR DE LOS LITROS

RENDIMIENTOS CERCANOS A LAS CALIDADES DE COCCIÓN OBTENIDAS CON UTENSILIOS DE COBRE O HIERRO FUNDIDO

COMPATIBLE CON TODO TIPO DE FUEGOS, INCLUIDOS LO DE INDUCCIÓN

NEWCOOK EXPERT

MADE IN FRANCE





SERVICE DE RÉASSORT



DEGRENNÉ s'engage à vos côtés en vous offrant la possibilité d'effectuer **une commande de réassort pendant les 3 années qui suivent l'arrêt de commercialisation de nos couverts**. Ce service s'applique aux collections identifiées dans ce catalogue par ce pictogramme. Dans le cadre de ce service, **vous avez la possibilité de commander les pièces qui vous manquent, une fois par an et selon les conditions définies** : contactez nos équipes commerciales pour toute demande. Le service de réassort est valable pour les pièces suivantes : Fourchette de table – Cuillère de table – Couteau de table (excepté couteaux monoblocs) – Fourchette à poisson – Couteau à poisson – Fourchette à dessert – Cuillère à dessert – Couteau à dessert (excepté couteaux monoblocs) – Cuillère à café – Cuillère à moka.

REPLACEMENT PRODUCT SERVICE



DEGRENNÉ enables you to **order replacement products for a further three years after cutlery is discontinued**. This service applies to the collections bearing the logo in the catalogue. This service enables you to **order any items you need once a year and in accordance with the following terms and conditions**: please contact our sales teams if you need to order any products. The replacement products service is available for the following products: table fork, table spoon, table knife (excluding solid handle knife) fish fork, fish knife, dessert fork, dessert spoon, dessert knife (excluding solid handle knife) coffee/tea spoon and moka spoon.

SERVICIOS



DEGRENNÉ se compromete a ofrecerle la **posibilidad de efectuar un pedido de renovación de existencias durante los 3 años siguientes al final de la comercialización de nuestros cubiertos**. Ese servicio se aplica a las colecciones identificadas en este catálogo con el pictograma. En el marco de ese servicio, **tiene la posibilidad de pedir las piezas que le faltan, una vez al año y según las condiciones definidas**: póngase en contacto con nuestros equipos comerciales para cualquier solicitud. El servicio de renovación de existencias es válido para las siguientes piezas : Tenedor de mesa – Cuchara de mesa – Cuchillo de mesa (salvo cuchillo pesado) – Tenedor de pescado – Cuchillo de pescado – Tenedor de postre – Cuchara de postre – Cuchillo de postre (salvo cuchillo pesado) – Cucharilla de café – Cucharilla de moka.



SERVICE DE PERSONNALISATION

Créez votre table personnalisée grâce au savoir-faire DEGRENNE. **DEGRENNE rend votre table unique grâce à ses services de personnalisation** : couverts, verres, plateaux ou vaisselle, découvrez un large choix de produits et de finitions. Chaque projet de personnalisation est **un service sur-mesure** qui fait l'objet d'**une étude personnalisée** par nos commerciaux.

CUSTOM - MADE SERVICE

Use DEGRENNE's expertise to create your own table. **DEGRENNE's custom - made service can make your table unique**: explore our wide range of products and finishes, including cutlery, glasses, trays and tableware. Our sales executives deliver **a bespoke service for each and every personalization order**.

SERVICIO DE PERSONALIZACIÓN

Cree su mesa personalizada gracias al saber hacer de DEGRENNE. **DEGRENNE hace que su mesa sea única gracias a sus servicios de personalización**: cubiertos, copas, bandejas o vajilla, descubra una amplia elección de productos y de acabados. Cada proyecto de personalización es un **servicio a medida** que es objeto de un **estudio personalizado** por parte de nuestros comerciales.



VERRERIE

GLASSWARE
COPAS

**AJOUTEZ VOTRE LOGO SUR LE PIED DU VERRE
AJOUTEZ VOTRE LOGO OU UN TRAIT DE JAUGE SUR LA PARAISSON
(LE LOGO SUR LA PARAISSON PEUT ÉGALEMENT FAIRE OFFICE DE JAUGE)**

**ADD YOUR LOGO TO THE BASE OF THE GLASS
ADD YOUR LOGO OR A MEASURE MARKING ON THE BOWL
(THE LOGO ON THE BOWL CAN ALSO BE USED AS THE MEASURE MARKING)**

**AÑADA SU LOGOTIPO EN LA BASE DE LA COPA
AÑADA SU LOGOTIPO O UN INDICADOR DE NIVEL EN EL CÁLIZ
(EL LOGOTIPO EN EL CÁLIZ TAMBIÉN PUEDE SERVIR COMO INDICADOR DE NIVEL)**





VAISSELLE

DINNERWARE
VAJILLA

AJOUTEZ VOTRE LOGO
RÉALISEZ UN DÉCOR SPÉCIFIQUE
APPLIQUEZ UN FILET DE LA COULEUR DE VOTRE CHOIX

ADD YOUR LOGO
ADD A SPECIAL PATTERN
APPLY A THIN STRIPE OF THE COLOUR OF YOUR CHOICE

AÑADA SU LOGOTIPO
REALICE UNA DECORACIÓN ESPECÍFICA
APLIQUE UN BORDE DE COLOR DE SU ELECCIÓN





COUVERTS FLATWARE CUBIERTOS

& PLATERIE HOLLOWARE ORFEBRERÍA

AJOUTEZ VOTRE LOGO : EN FONCTION DE VOS ATTENTES, NOUS PROPOSONS LA GRAVURE LASER POUR UNE GRANDE PRÉCISION OU LE MARQUAGE AU POINÇON POUR UNE TENUE INALTÉRABLE DANS LE TEMPS

ADD YOUR LOGO : IN ACCORDANCE WITH YOUR REQUIREMENTS, WE OFFER LASER ENGRAVING IF HIGH PRECISION IS NEEDED, OR ALTERNATIVELY METAL STAMPING FOR ITEMS NEEDING TO STAND THE TEST OF TIME

AÑADA SU LOGOTIPO: EN FUNCIÓN DE SUS EXPECTATIVAS, LE PROPONEMOS EL GRABADO LÁSER PARA UNA GRAN PRECISIÓN O EL MARCADO CON PUNZÓN PARA UNA RESISTENCIA EN EL TIEMPO INALTERABLE





PERSONNALISEZ VOTRE FINITION

PERSONALIZE THE FINISH
PERSONALICE SU ACABADO

L'ARGENTURE AVEC POINÇON DE MAÎTRE :
ARGENTURE DE CLASSE I (33 MICRONS POUR
LES ARTICLES À USAGE FRÉQUENT) OU ARGENTURE
QUALITÉ HÔTELIÈRE (10 MICRONS)

SILVER PLATING WITH A MAKER'S MARK: CLASS I SILVER
PLATING (33 MICRONS FOR FREQUENTLY USED ITEMS)
OR HOTEL QUALITY SILVER-PLATING (10 MICRONS)

LA PLATEADURA CON PUNZÓN DE MAESTRO: PLATEADURA
DE CLASE I (33 MICRONS PARA LOS ARTÍCULOS DE USO
FRECUENTE) O PLATEADURA DE CALIDAD HOTELERA
(10 MICRONES)



**LA FINITION PVD: PROCÉDÉ DE MÉTALLISATION QUI
PERMET DE RÉALISER UN PLACAGE IONIQUE.**
DISPONIBLE DANS LES COLORIS NOIR, DORÉ,
CUIVRE ET HOLOGRAPHIC SOUS CONDITIONS
PARTICULIÈRES, CONTACTEZ NOS ÉQUIPES.

PVD FINISH: VACUUM DEPOSIT METALLIZATION PROCESS.
AVAILABLE IN BLACK, GOLD, COPPER AND HOLOGRAPHIC
COLORS UNDER SPECIAL CONDITIONS, CONTACT OUR SALES
TEAMS.

RECUBRIMIENTO PVD: PROCEDIMIENTO DE
METALIZACIÓN POR DEPÓSITO AL VACÍO. DISPONIBLE EN
LOS COLORIDOS NEGRO, DORADO, COBRE Y
HOLOGRÁFICA BAJO CONDICIONES PARTICULARES,
PONGASE EN CONTACTO CON NUESTROS EQUIPOS.



LA DORURE : DORURE À L'OR FIN DES COUVERTS OU DE CERTAINES PARTIES DES COUVERTS

GILDING : CUTLERY OR ALTERNATIVELY SOME SECTIONS OF CUTLERY CAN BE GILDED WITH FINE GOLD

LA DORADURA : DORADURA CON ORO FINO DE LOS CUBIERTOS O DE ALGUNAS PARTES DE LOS CUBIERTOS

LA FINITION ÉTAÏN : POLISSAGE SPÉCIFIQUE DES COUVERTS POUR UN EFFET VIEILLI FAÇON ÉTAÏN

PEWTER FINISH: SPECIALLY POLISHED CUTLERY FOR A PEWTER-STYLE ANTIQUE EFFECT

EL ACABADO DE ESTAÑO : PULIDO ESPECÍFICO DE LOS CUBIERTOS PARA UN EFECTO ENVEJECIDO TIPO ESTAÑO

LA FINITION BROSSÉE OU SATINÉE : POLISSAGE SPÉCIFIQUE DES COUVERTS OU DES ACCESSOIRES DE PLATERIE POUR UN RENDU MAT

BRUSHED OR SATIN FINISH: SPECIALLY POLISHED CUTLERY AND HOLLOWARE ACCESSORIES FOR A MATT FINISH

EL ACABADO MATE O SATINADO : PULIDO ESPECÍFICO DE LOS CUBIERTOS O DE LOS ACCESORIOS DE PLATERÍA PARA UN ACABADO MATE



A series of horizontal dotted lines spanning the width of the page, providing a guide for handwriting practice.

A series of horizontal dotted lines for writing notes.



A series of horizontal dotted lines spaced evenly down the page, serving as a guide for handwriting practice.

A series of horizontal dotted lines for writing notes.



GARANTIE MICRO-ONDES
MICROWAVE SAFE
GARANTÍA MICRO-ONDAS



GARANTIE LAVE-VAISSELLE
DISHWASHER SAFE
GARANTÍA LAVA-VAJILLAS



GARANTIE CONGÉLATEUR
FREEZER SAFE
GARANTÍA CONGELADOR



GARANTIE FOUR
OVEN SAFE
GARANTÍA HORNO



FINITION MÉTAL ARGENTÉ - ARGENTURE
CLASSE 1 - 33 MICRONS (POUR LES
ARTICLES À USAGE FRÉQUENT)
SILVER PLATED FINISH - CLASS 1 SILVERPLATING -
33 MICRONS
ACABADO PLATEADO - TIPO CLASE 1 - 33 MICRAS



ARGENTURE QUALITÉ HÔTELIÈRE-10 MICRONS
SILVER PLATED HOTEL QUALITY- 10 MICRONS
ACABADO HOTEL QUALITY - 10 MICRONES



FINITION MIROIR
MIRROR FINISH
ACABADO BRILLO



FINITION SATINÉE
SATIN FINISH
ACABADO CEPILLADO



FINITION VINTAGE
VINTAGE FINISH
ACABADO VINTAGE



FORGÉ
FORGED
FORJADO



ACIER INOXYDABLE
STAINLESS STEEL
ACERO INOXIDABLE



EPAISSEUR FOURCHETTE DE TABLE
THICKNESS TABLE FORK
ESPESOR TENEDOR DE MESA



RÉASSORT
REPLACEMENT
RENOVACIÓN



REVÊTEMENT PVD
PVD COATING
REVESTIMIENTO PVD



VERRE
GLASS
CRISTAL



SHQ/ SODOCALCIQUE
HAUTE QUALITÉ
HIGH QUALITY SODA - LIME
SODOCÁLCICO ALTA CALIDAD



CRISTALLIN HAUTE QUALITÉ
HQ LOW LEAD CRYSTAL
CRISTALINO ALTA CALIDAD



VERRE SOUFFLÉ BOUCHE TEINTÉ
DANS LA MASSE
HAND-BLOWN INTEGRALLY DYED GLASS
VASO SOPLADO A BOCA, PINTADO EN MASA



1000 CYCLES GARANTIS MINIMUM
1000 WASH CYCLES GUARANTEED
1000 CICLOS DE LAVADO GARANTIZADOS



PORCELAINE
PORCELAIN
PORCELANA



PORCELAINE DE LIMOGES
LIMOGES PORCELAIN
PORCELANA DE LIMOGES



AIMANTÉ
WITH MAGNET
CON IMÁN



GRÈS
STONEWARE
ARENISCA

MARQUES DÉPOSÉES / COPYRIGHTS / MARCAS REGISTRADAS



FRANCE USA

SIEGE SOCIAL / HEAD OFFICE / SEDE SOCIAL
SERVICE CLIENTS / CUSTOMER SERVICES / ATENCIÓN AL CLIENTE

RUE GUY DEGRENNE - BP 50056
14502 VIRE CEDEX
FRANCE
FRANCE - TEL : +33 (0)2 31 66 44 15

OTHER COUNTRIES / OTROS PAÍSES
TEL : +33 (0)2 31 66 44 00

infohotel@degrenne.fr

FILIALE USA / US SUBSIDIARY

DNA/DEGRENNE NORTH AMERICA INC.
390 GEORGE STREET - SUITE 404
NEW BRUNSWICK, NJ 08901 - USA

TEL : 732 565 0820
FAX : 732 565 0828

csrv.dna@degrenneparis.com
www.degrenneparis.us

DIRECTION GÉNÉRALE / GENERAL MANAGEMENT / DIRECCIÓN GENERAL
DIRECTION MARKETING - MARKETING DIVISION - DIRECCIÓN DE MARKETING
DIRECTION COMMERCIALE - SALES DIVISION - DIRECCIÓN COMERCIAL
SHOWROOM (SUR RENDEZ-VOUS)

89 RUE LA BOÉTIE
75008 PARIS
FRANCE

SHOWROOM (BY APPOINTMENT)

NEW YORK (41 MADISON)



FRANCE
infohotel@degrenne.fr
Tel : +33 (0)2 31 66 44 15

OTHER COUNTRIES/OTROS PAISES
infohotel@degrenne.fr
Tel : +33 (0)2 31 66 44 00

FILIALE USA/US SUBSIDIARY
csrv.dna@degrenneparis.com
Tel : 732 565 0820



www.pro.degrenne.fr